



Glorious Life From LEDMY

Product Catalog 2024-2025



- Flexible strip light**
- Neon light**
- Linear light**
- Intelligent system**
- Power supply
- Controller
- Aluminum profile
- Accessory

Focus on developing high quality
Linear illumination source system

Contents

01

About Ledmy

Enterprise Profile	6-15
Color Consistency	16-17
Full Spectrum	

02

New Product

Module Wall washer	20-21
3D Wall Washer	23-23
NEON 360° Lighting	24-27
220V High Voltage NEON	28-29
Rainbow NEON	30-31
High Efficacy NEON	32-33
High Efficacy COB	34-35
Ultra-Long COB	36-37
Free Cut COB	38-39
220V High Voltage COB	40-41
Spotless Lighting Series	42-43
Energy-saving Series	44-45
Sauna Room LED Strip	46-47
Swimming Pool LED Strip	48-47
A Single Strip Optional Three Power	50-51
110V-220V High Voltage	52-23

03

NEON SERIES

Top Bending	50-65
Side Bending	66-77
Mini NEON	78-91
Long-Run NEON	92-103
360° Lighting NEON	104-113
3D Bending NEON	114-117
IP68 NEON	118-127
Digital Colorful NEON	128-147

04

COB Series

COB Honor (Weldless) Series	
White (DC12/24V)	166
R/G/B/Y	167
High Efficacy COB	168-169
COB Ultra-Long (Up to 15m)	170-171
COB Essential Series	
White (Weldless)	172
R/G/B/Y (Weldless)	173
Mini Cut	174-175
Free Cut	176-177
Mini PCB	178-179
Extra wide 30mm	180-181
COB Colorful	182-185
COB SPI Digital	186-189
220V COB High Voltage	190-191
Black Gold	192-193
Accessories & Installation	184-195

05

Flexible Wall Washer Series

Module Wall washer	198-199
3D Wall washer	200-201
Rainbow Wall washer	202-203
Spotless wall washer	204-205
Mini wall washer	206-213

06

LED Strip Series

Honor Series (24V / 12V)	216-227
2835 / 5050	
Essential Series (24V / 12V)	228-237
2835 / 3528 / 5050	
ErP Series	238-273
Energy Saving Series	274-277
Spotless Series	278-291
2835 Reel To Reel Series	293-301
Ultra-Long Series	302-341
24V / 48V / 110-220V	
Mini LED Series	342-359
2110 / 2216 Plus	
DTW LED Strip Series	358-365
Constant Current Resistor-Free	366-367
Sauna Room LED Strip	368-369
Swimming Pool LED Strip	370-371
A Single Strip Optional Three Power	372-373
Cabinet LED Strip (24V / 12V)	374-375
Multi-Row Strip	376-381
CRI 95 / 98	382-389
Colorful Series	390-409

07

Digital Colorful

SPI Series	412-417
DMX Series	418-429

08

Special Series

Soft Lighting 1206	432-433
4020 Side Emitting Series	434-435
160° Monolithic Integrated Lens	436-437
12V / 24V Switchable Series	438-439
Haute Color Series	440-441
Fresh Food / Jewelry Lighting	442-443
S Type Series	444-447

09

Accessories

Connectors	450-453
Aluminum Profile List	454-569
LED Driver	470-477
Controllers	478-481
IP Rating	482-483
Naming Guidance	484



Enterprise Profile

Focus on developing high quality Linear illumination system

Founded in 2009, Shenzhen LEDMY CO.,Ltd is a leading comprehensive LED lighting manufacturer integrating R&D, production and sales with quality led lighting source as our core, providing customized lighting solutions and professional services. After years of development, Ledmy has become a highly competitive LED linear lighting brand and enjoys a good reputation at home and abroad. LEDMY has 70,000 square meters workshop, 500+ employees, 50+ engineers, all automatic production lines, and more than 150 modernized equipments in DongGuan City. The new LEDMY Industrial Park with 60,000 square meters have officially put into production in Jiangmen City in 2023.

As one of the most professional manufacturers for LED Strip in China, we are qualified for ISO9001, UL, UKCA, CE, ROHS, ErP, Reach certifications. With more stable quality, faster delivery, higher cost-effective, we have won high recognition and favor of many customers.

15+
Experience

70,000+m²
Production area

500+
Excellent staffs

34,000,000+ m
Annual production capacity



2009

Shenzhen LEDMY
Marketing and Sales



2010

HK LEDMY
Logistic and Service



2015

Dongguan LEDMY
R&D and Manufacturing



2023

Jiangmen LEDMY
R&D and Manufacturing

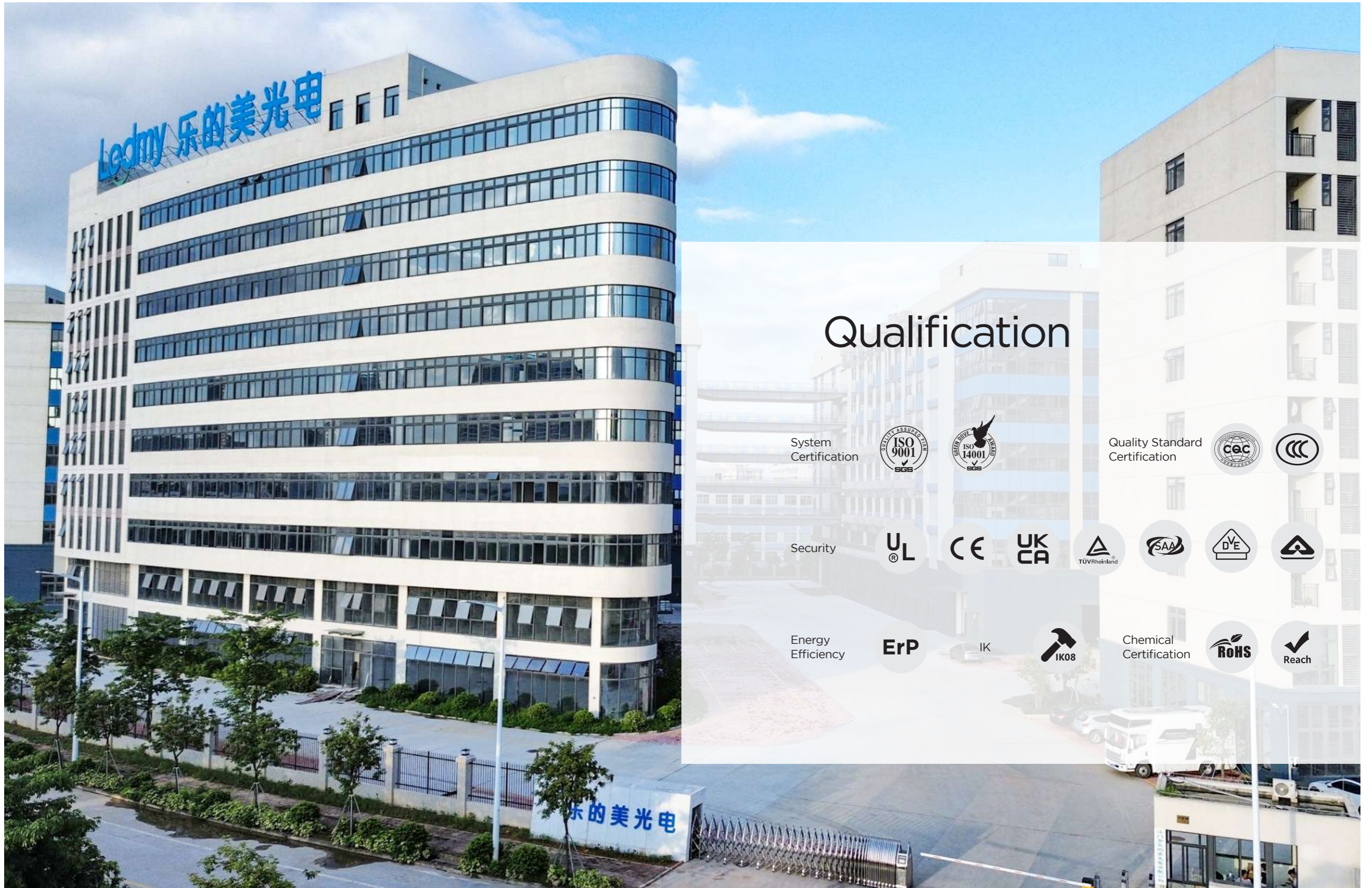

Qualification

System Certification



Quality Standard Certification



Security



Energy Efficiency



Chemical Certification



① Manufacturing Capacity

Complete production process of LED packaging, high speed SMD, automatic welding and full range of waterproof. Monthly average production capacity of led strip 2,500,000 meters. Stable quality, strong production capacity, strong delivery ability, provide quality products to customers in time.



② R&D Capacity

The company implements agile development on the IPD-based R&D system, responding to customer needs professionally and quickly. We have 40 practical new patents, 3 invention patents, and a team of over 30 technicians, with more than 10 years of experience in the optic industry and technical accumulation in the fields of optics, structuring, technology, material science, electricity, thermology, intelligence control, and industrial design. The company highly values R&D innovation, and we are a multidisciplinary team with a solid theoretical foundation and market foresight.



③ LED Quality Warranty

LEDMY has a million-class professional and precision LED dust-free workshop, with oriented production according to ANSI standards. Strict selection of materials, always insist use 99.99% pure gold wire to ensure good conductivity and high temperature resistance. The product with pure color, the center of the color coordinate of each white color temperature is near the black body line, and the XY controlled between 0.005 to 0.007, which is much higher than the industry standard. The product with high color consistency, we can provide single BIN for VIP customers and large projects.

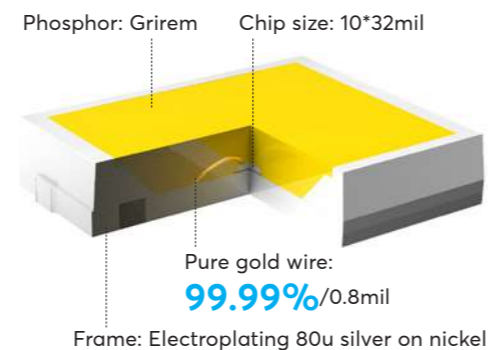

LED Encapsulation Ability



Packaging Process

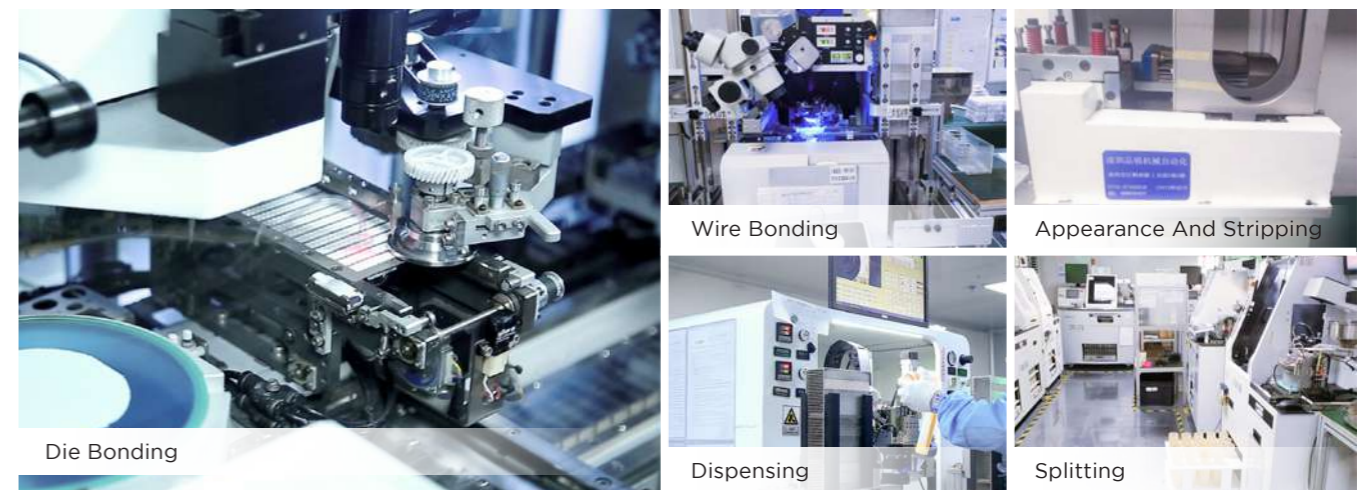

Packaging Equipment



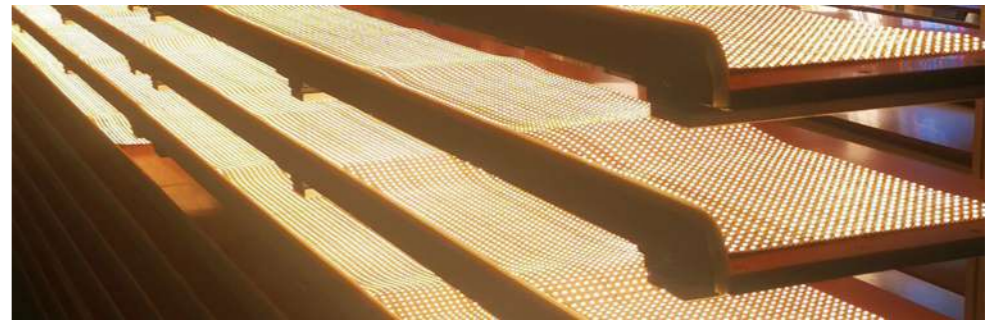
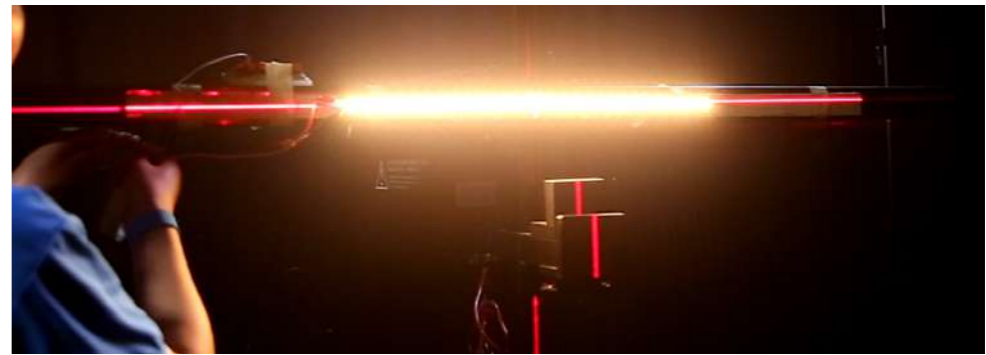

Quality Control Ability

Company has a number of thermal shock, constant temperature and humidity, salt spray test machine, IES tester, integrating sphere, transportation simulation tester etc. To verify and ensure the product meet the standards of photoelectric, lifespan and weather resistance.

Color Consistency

Color temperature control

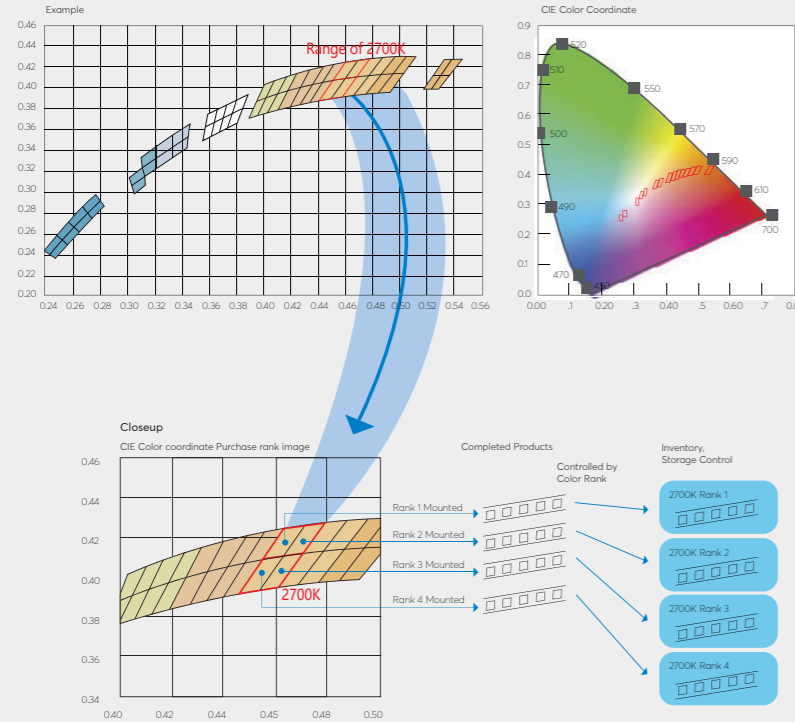

SDCM < 1 step ± 50k

Only single Bin in the LED packages would be selected to customer's every and each order. For all the LEDs, there would be additional visual inspection after the selection of machine. All the orders would have both documents record and actual LED samples for comparison. Customized colors are available since we have our own LED packaging facilities.

Please note that the color temperatures of some of the products sold by LEDMY are outside the industry standard to meet the needs of our customers. LEDMY original rules have been set for these.

Full Spectrum

FIDELITY Index (Rf) base on the TM-30

TM-30 is a new and improved IES method for characterizing the color rendering ability of white light sources. While CRI and extended CRI utilize 8 and 15 color samples respectively, they do not necessarily represent the actual colors that we would encounter in the real world. The new fidelity index (Rf) developed under TM-30, dissimilarly utilizes 99 color samples in its calculation, providing a much more statistically representative and reliable metric in describing a light source's ability to faithfully render colors. In line with CRI, the best possible score for Rf under the TM-30 standard is 100.

FULL COLOR GAMUT (Rg) AS PER TM-30-15

In addition to an improved color fidelity metric, the TM-30 method introduces an additional dimension to color quality through the gamut index (Rg). The Rg gamut index provides information about the relative range of colors that can be produced (via reflection) by a white light source. A score close to 100 indicates that, on average, the light source reproduces colors with similar levels of saturation as an incandescent bulb (2700K) or daylight (5600K/6500K). For LEDs of decent color quality, Rg can typically range between 80 and 120, with higher scores representing higher overall levels of saturation.



CRI > 95



Light color consistency is an important indicator of LED strip quality, while the quality of LED source is determined by LED components. Every process with strict control is vital importance for LED components manufacturing, such as ratio control of phosphors, glue dispensing, sorting, SMT and testing. In order to make sure non-defective passing to our customers, inspections and comparisons of color consistency are needed, the main steps as below:

Step 1

First, inspect the appearance of the LED chip, make sure LED surface is clean, no stains and spots, no short bridging in soldering.

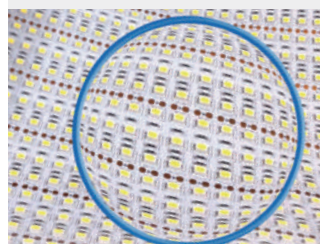

Step 2

Second, laying the finished product on the testing shelf, turn on lights to mark the defective such as dead LEDs, open soldering, glue crack and excessive brightness.



Step 3

Third, cover led source with PMMA board, observe the color of the finished products and compare color with the first piece sample to ensure the color consistency. Meanwhile, mark the defective products with labels.

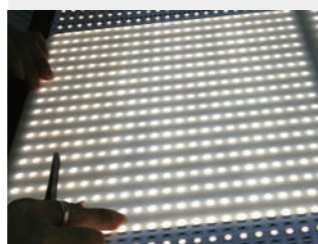

Step 4

Fourth, defective products will be returned for analysis and repairing.

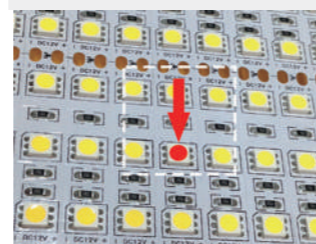

Violet Chip Full Spectrum (Nature Light Series)

CRI up to 98

Very similar to sunlight spectrum, make the color of lighting object more close to its color under natural light, high color high similarity to sunlight spectrum, making the color of illuminated object closer to its color which under natural light, high color reproduction, Rf > 98, high color saturation, Rg ≥ 100, lower harmful Blue tu maleta, healthy lighting.

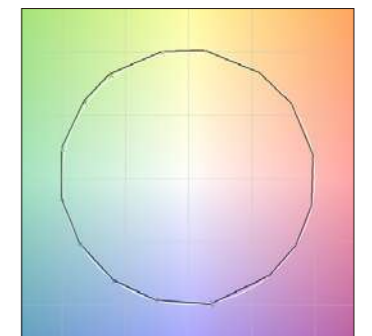
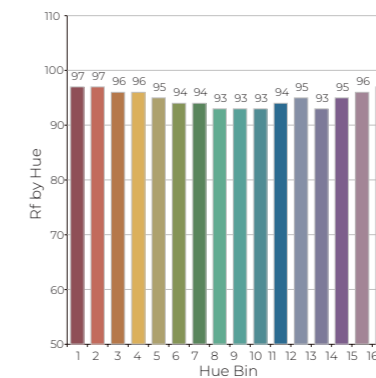
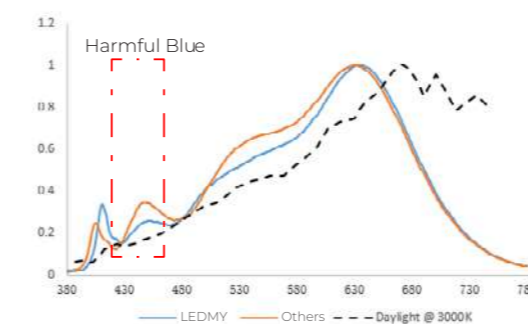

NEW PRODUCT

Module Wall washer

3D Wall washer

NEON 360° Lighting

High Voltage NEON

Rainbow NEON

High Efficacy NEON

High Efficacy COB

Ultra-Long COB

Free cut COB

High Voltage COB

Spotless Lighting Series

Energy-saving series

Sauna Room LED strip

Swimming Pool LED Strip

A Single strip Optional Three power

110V-220V High Voltage



Module Wall washer

30x21mm



1 Module
Cut



IP67



Warranty

Break through space limitations.

Designed for unconventional space.
Not just appearance, more creativity and feasibility.

Washing height up to 7.5m.

Minimum bending diameter down to 20cm.

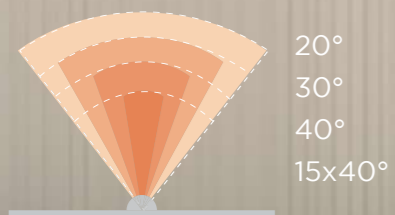

Various beam angle are available.



The details of this product are on page 198-199.

3D Wall washer

24x18mm

Bending Freely



UV Resistant



IP67



Warranty

 Top Bending

 Side Bending

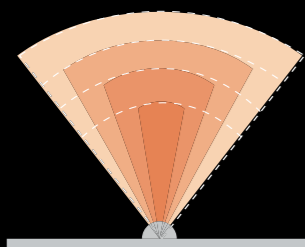

20°
30°
40°
15x40°

Various beam angle are available.

The details of this product are on page 200-201.

Weaving pattern on the surface

NEON 360° Lighting

The flexibility enables us to move and interact with the environment in new and unpredictable ways.



360°
Lighting



IP65
waterproof



More
applications



Arbitrarily
Cutting

The details of this product are on page 116-127.

Shapeable bendable, free DIY

NEON 360° Lighting

360° lighting, surface illuminate uniformly without any dark area.

Matte oil material used on the surface, with excellent wear resistance, no dust, Soft and smooth feel of hand touch.



360°
Lighting



IP65
waterproof



More
applications

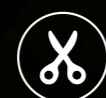

Arbitrarily
Cutting

The details of this product are on page 116-127.

DC 220V High Voltage NEON

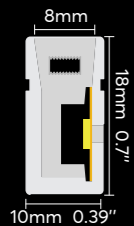

The details of this product are on page 82-83.

Rainbow NEON

Customize color

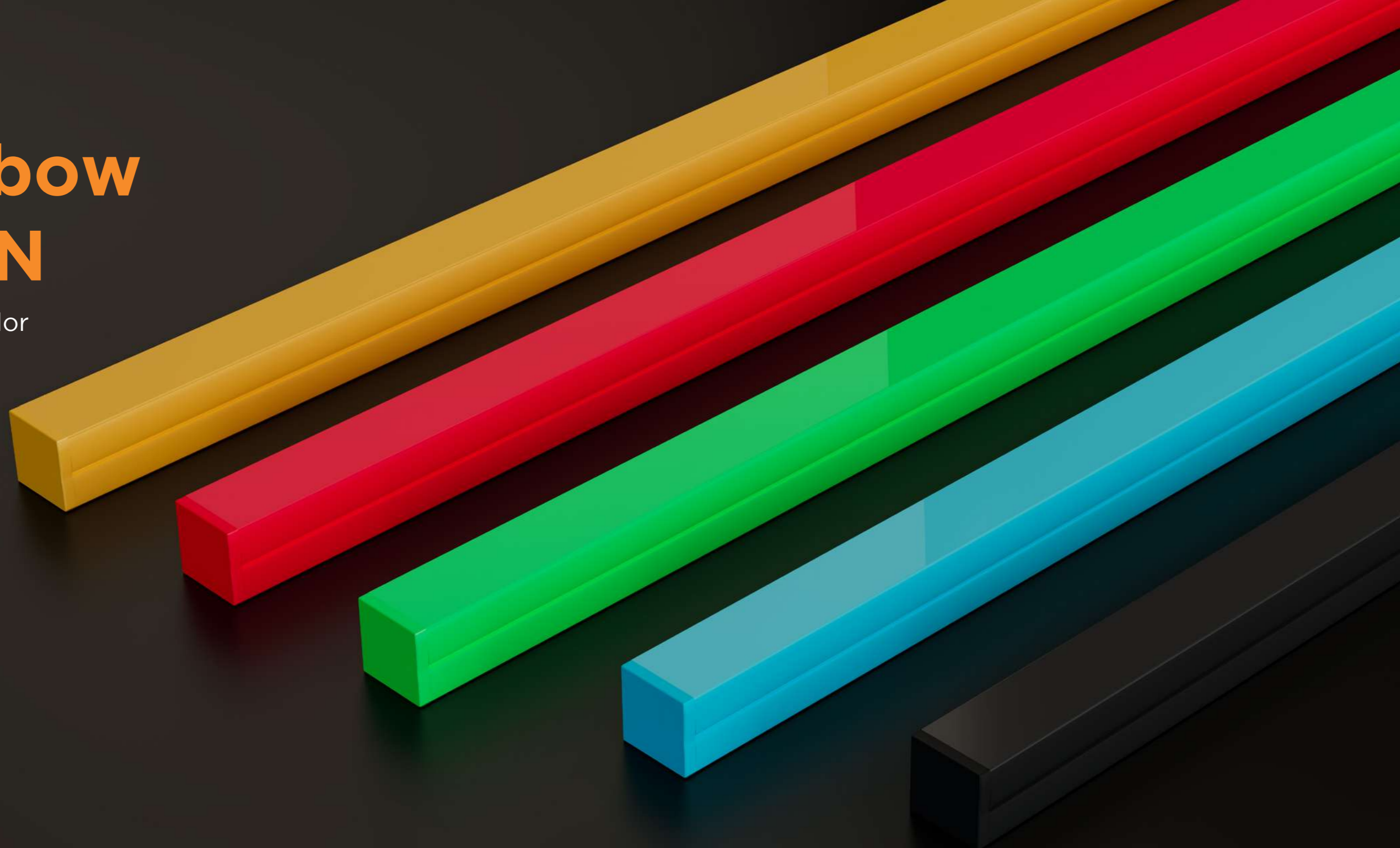
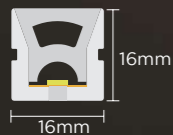

Customize color



Dots-free



Matte
oil material



IP67
waterproof

The details of this product are on page 66-67.

High Efficacy NEON

Up to 96LM/W



Up to IP67



IK08



Dots-free



More stable

The details of this product are on page 64-65.

High Efficacy COB

Up to 140lm/w



Light efficiency increased by

30%

* Power: 8W / Led Qty: 320led/m Im/w

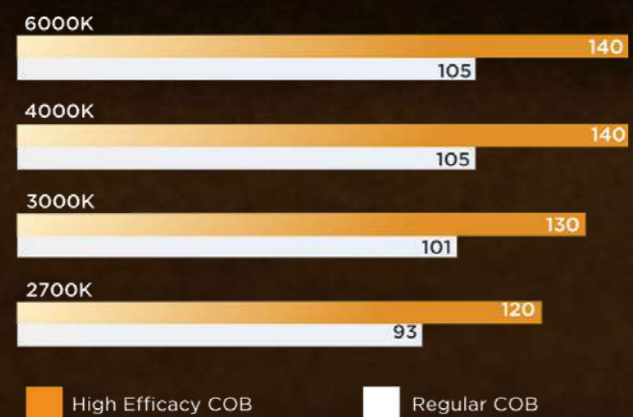

Bigger Chip, more Stable.
No quality risk of lap welding.

The details of this product are on page 168-169.

Ultra-Long COB

Up to 15m

15m ultra-long strip driven by one end power supply.
The same brightness from end to end.

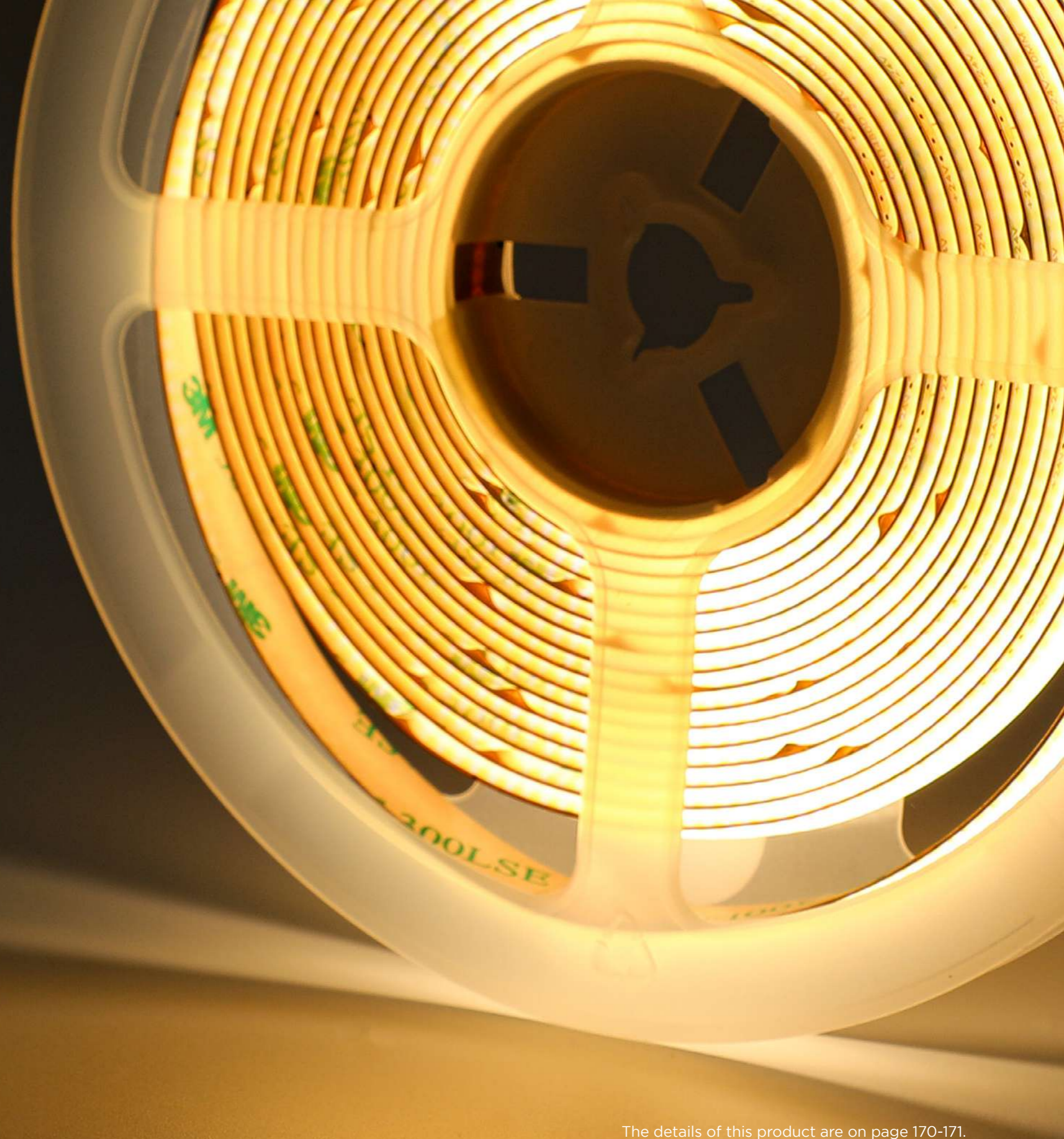

The details of this product are on page 170-171.

Free cut COB

Cut any where.
Dot-free, ideal for linear or even direct illumination.



The details of this product are on page 176-177.

DC 220V High Voltage COB



The details of this product are on page 190-191.

Spotless Lighting Series



Free Cut



Beam angle 180°



Higher efficiency



Dots-free

Beam angle 180°.

High efficacy.

Bendable at horizontal direction.

Extrusion process, 3M tape Easy installation.

Connector

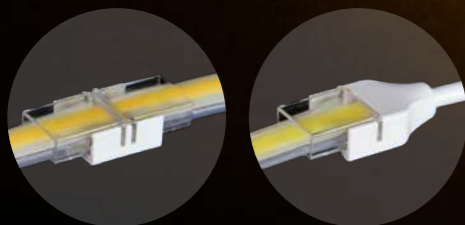

The details of this product are on page 278-291.

Energy-saving series

Energy-saving 20%

Better than standard strip lights.
Save electricity and reduce carbon emissions.



The details of this product are on page274-277.

Sauna Room LED strip



Up to IP65



More stable

5 years warranty@Ta 85°C
3 years warranty@Ta 100°C
Apply to bathroom sauna.



The details of this product are on page 368-369.

Swimming Pool LED Strip

Up to 10m

Safety.
Durable, Corrosion-resistant.
Easy to Install.

IP68

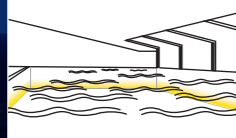

The details of this product are on page 370-371.

A Single strip Optional Three power

4.8W 725-755lm/m

9.6W 1430-1490lm/m

14.4W 2090-2770lm/m



The details of this product are on page 372-373.

110V-220V High Voltage

Perfect color control.
3M tape, Cuttable, large bending degree,
easy installation.
Ultra-long, up to 50 meters one end feed.



The details of this product are on page 336-341.

NEON SERIES

Top Bending

Side Bending

Mini NEON

Long-Run NEON

360° Lighting NEON

3D Bending NEON

IP68 NEON

Digital Colorful NEON



Top bending



10x10mm

WHITE / RGB



Three-sided luminous, wide angle, uniform light, dot free.
 Top emitting, meet a variety of top bending light shape.
 IP67, achieve temporary immersion.
 With high quality silicon, UV proof for outdoor application.
 Easy installation with clips and bendable track. cuttable for flexible application.

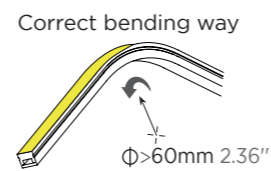

Accessories

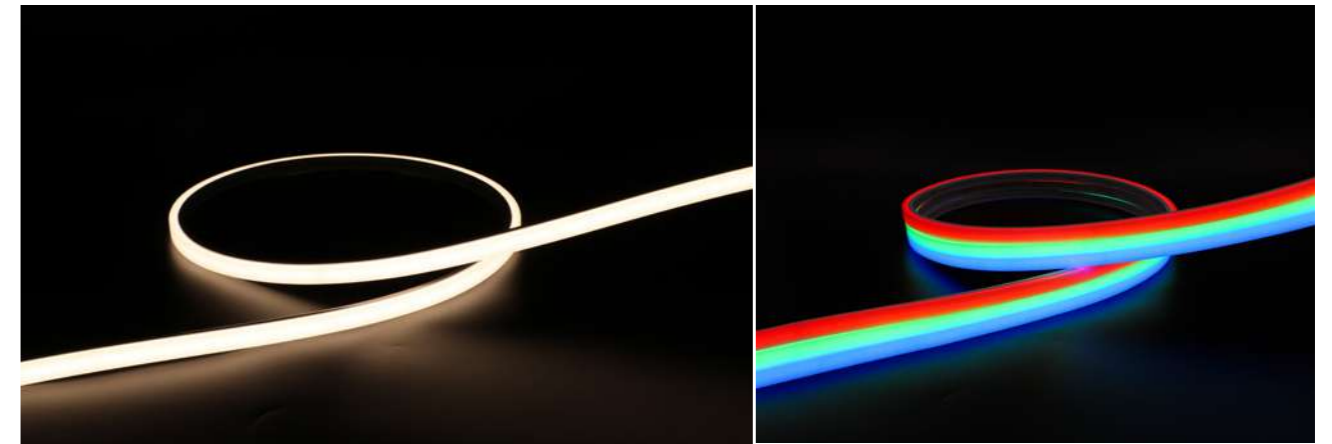

2700K 3000K 4000K 6000K



Technical Details 10x10mm White 14W

10x10mm RGB 14W

Product NO.	FEN14W-P7-G1 28LZ9x 24V182S7 1010L05	FEN14W-P7-G1 38XRGB 24V144S 1010L05
Voltage	DC24V	DC24V
Power	14W/M 4.26W/ft	14W/M 4.26W/ft
CRI	90 (2835LEDs)	- (3838LEDs)
Led Qty	182LEDs/M 55LEDs/ft	144LEDs/M 43LEDs/ft
Cutting Length	38.5mm 1.51"	41.7mm 1.64"
IP Grade	IP67	IP67
Length/Reel	5050mm 16.56ft	5050mm 16.56ft
Color temperature	● 2700K ● 3000K ● 4000K ○ 6000K	● R ● G ● B
Lumens	1305lm/m 398lm/ft 1380lm/m 420lm/ft 1380lm/m 420lm/ft 1380lm/m 420lm/ft	106lm/m 32lm/ft 302lm/m 92lm/ft 65lm/m 20lm/ft

End cap

Ordinary End Cap

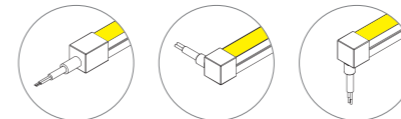

Mold end cap

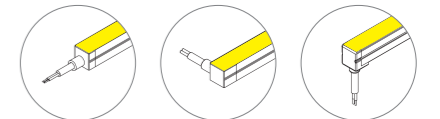

Dimension



※ Please contact our sales for the latest details and certifications

Top bending



Arc lighting 13x7mm

WHITE / 18W



Arc light-emitting surface, uniform light, not free
 Top emitting, meet a variety of top bending light shape
 IP67, achieve temporary immersion
 With high quality silicon, UV proof for outdoor application



Accessories

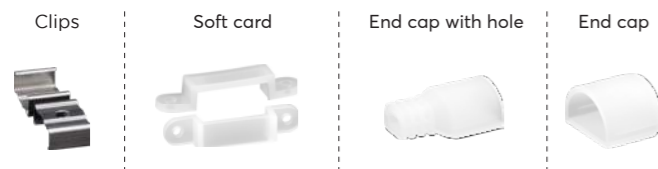

Correct bending way

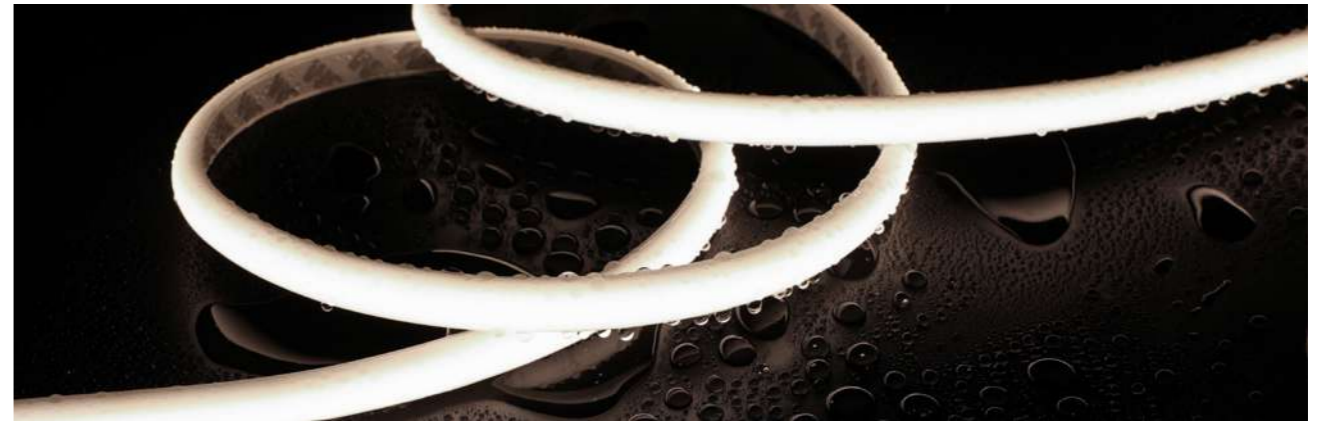

2700K 3000K 4000K 6000K

Technical Details 13x7mm White 18W

Product NO.	FEN18W-P7-G1 28HZ9x 24V210S 1307L05			
Voltage	DC24V			
Power	18W/M 5.49W/ft			
CRI	90 (2835LEDs)			
Led Qty	210LEDs/M 64LEDs/ft			
Cutting Length	33.3mm 1.31"			
IP Grade	IP67			
Length/Reel	5050mm 16.56ft			
Color temperature	2700K	3000K	4000K	6000K
Lumens	1640lm/m 500lm/ft	1670lm/m 509lm/ft	1680lm/m 512lm/ft	1680lm/m 512lm/ft

End cap

Ordinary End Cap



Dimension

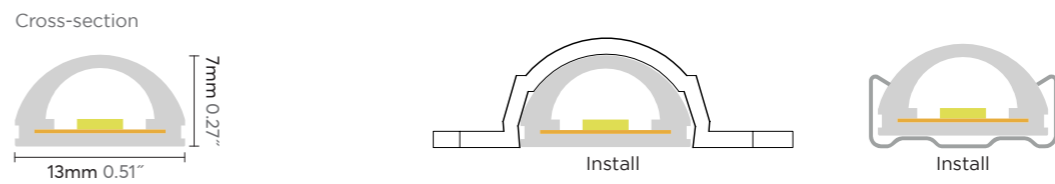

* Please contact our sales for the latest details and certifications

Top bending



16x16mm

WHITE / Tunable CCT



Seamless and uniform light output, dot free.
 Bendable at horizontal direction.
 Robust housing with high quality silicon, UV proof for true outdoor application.



Correct bending way

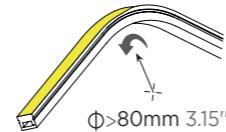

Accessories



2700K 3000K 4000K 6000K



Technical Details 16x16mm White 16W

Product NO.	FEN16W-P7-G1 28HZ9x 24V140S7 1616L05
Voltage	DC24V
Power	16W/M 4.87W/ft
CRI	90 (2835LEDs)
Led Qty	140LEDs/M 42LEDs/ft
Cutting Length	50mm 1.97"
IP Grade	IP67
Length/Reel	5050mm 16.56ft
Color temperature	● 2700K ● 3000K ● 4000K ○ 6000K
Lumens	920lm/m 940lm/m 960lm/m 960lm/m 280lm/ft 286lm/ft 292lm/ft 292lm/ft

16x16mm Tunable CCT 19W

Product NO.	FEN19C-P7-G1 28HZ92228HZ950 24V240S12 1616L05
Voltage	DC24V
Power	19W/M 5.85W/ft
CRI	90 (2835LEDs)
Led Qty	240LEDs/M 73LEDs/ft
Cutting Length	50mm 1.97"
IP Grade	IP67
Length/Reel	5050mm 16.56ft
Color temperature	● 2700K ○ 6000K
Lumens	450lm/m 540lm/m 137lm/ft 165lm/ft

End cap

Ordinary End Cap

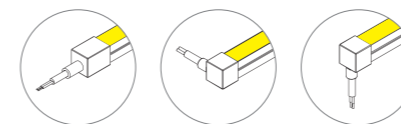

Mold end cap

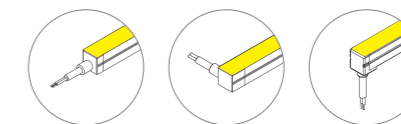

Injection-moulded endcap

*Cable can be bended to any direction.

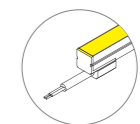

Dimension

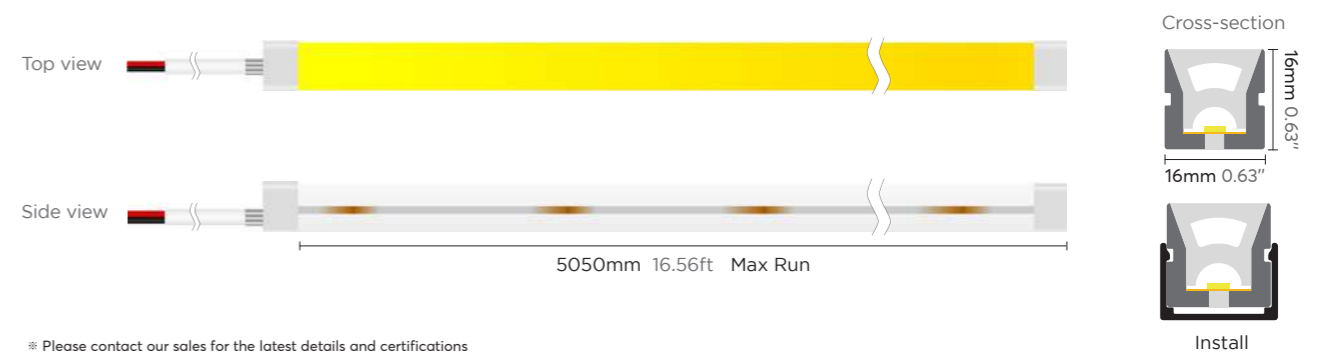

* Please contact our sales for the latest details and certifications

Top bending



16x16mm

RGB / RGBW

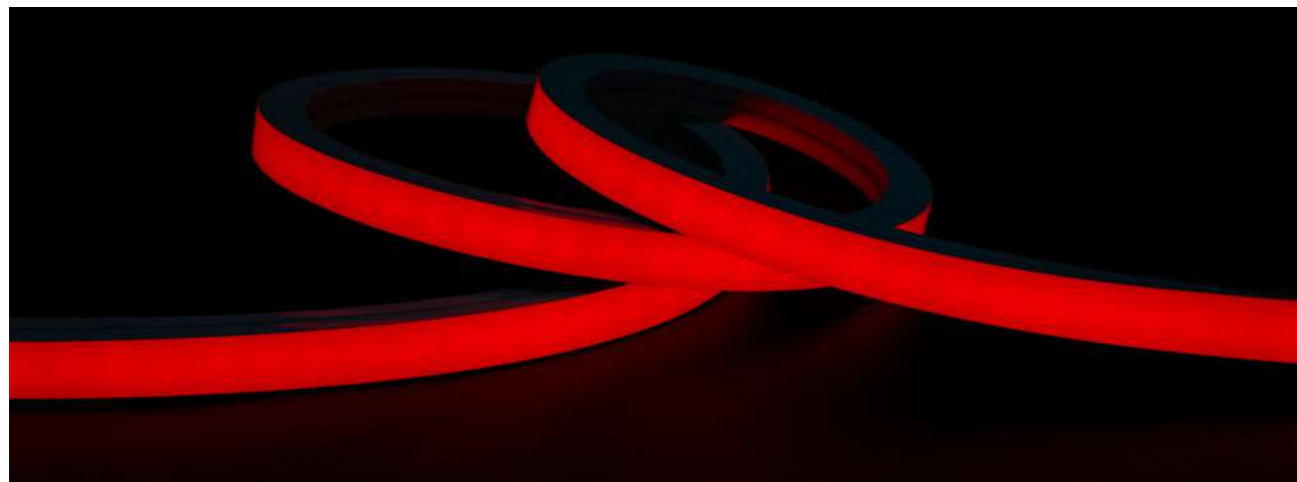

Seamless and uniform light output, dot free.
Bendable at horizontal direction.
Robust housing with high quality silicon,
UV proof for true outdoor application.

Correct bending way

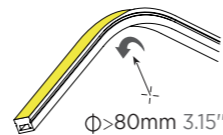

Accessories

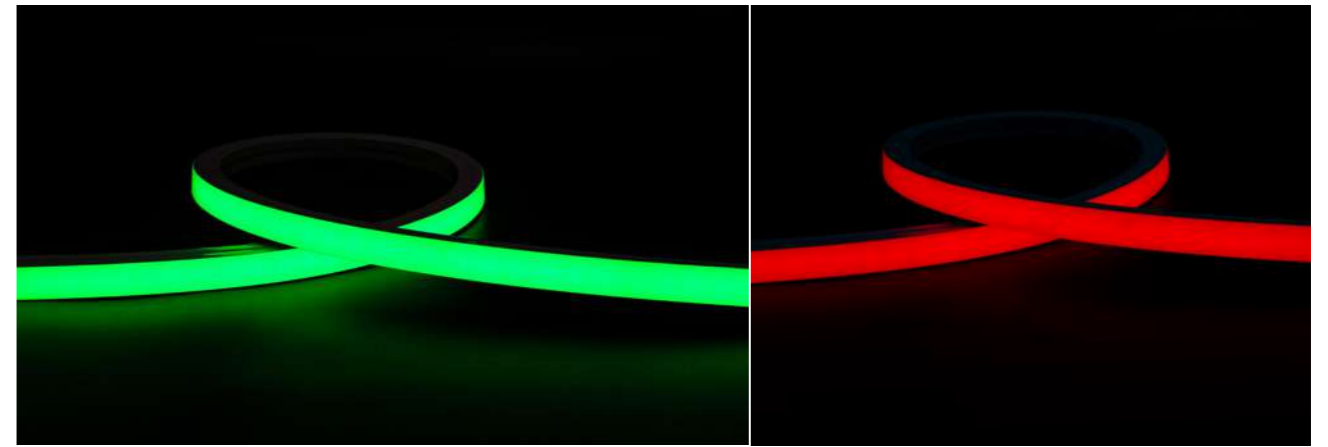

Technical Details 16x16mm RGB 9.6W

16x16mm RGBW 15W

Product NO.	FEN10C-P7-G2 50ZRGB 24V96S 1616L05			FEN15C-P7-G1 50ZRGB8X 24V96S 1616L05			
Voltage	DC24V			DC24V			
Power	9.6W/M 2.93W/ft			15W/M 4.57W/ft			
CRI	/ (5050LEDs)			/ (5050LEDs)			
Led Qty	96LEDs/M 29LEDs/ft			96LEDs/M 29LEDs/ft			
Cutting Length	62.5mm 2.46"			67mm 2.63"			
IP Grade	IP67			IP67			
Length/Reel	5050mm 16.56ft			5050mm 16.56ft			
Color temperature	● R	● G	● B	● R	● G	● B	● 3000K
Lumens	58lm/m 17lm/ft	150lm/m 45lm/ft	37lm/m 11lm/ft	58lm/m 17lm/ft	150lm/m 45lm/ft	37lm/m 11lm/ft	144lm/m 43lm/ft

End cap

Ordinary End Cap

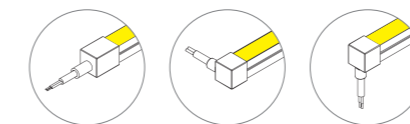

Mold end cap

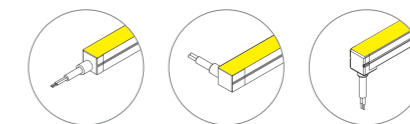

Injection-moulded endcap

*Cable can be bent to any direction.

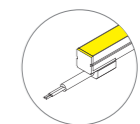

Dimension

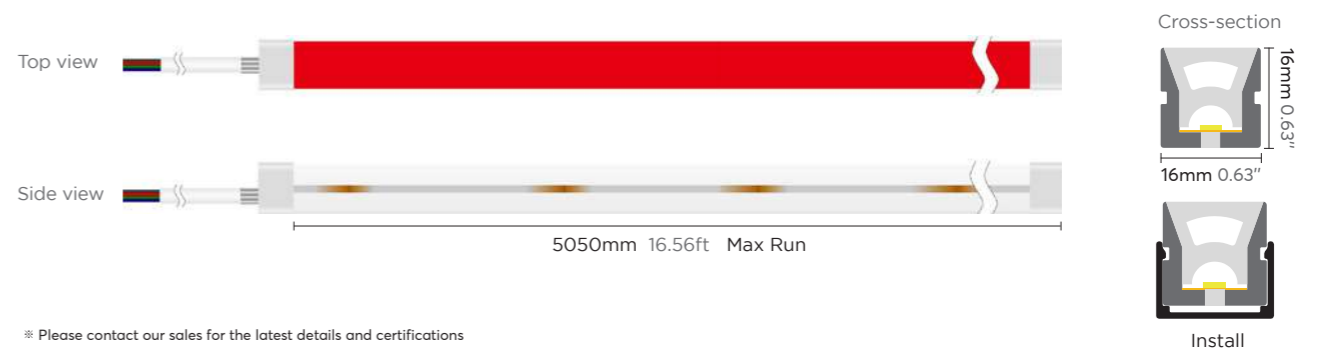

* Please contact our sales for the latest details and certifications

Top bending



High-Efficiency NEON

Up to 96lm/w

16x16mm WHITE



Seamless and uniform light output, dot free.
 Bendable at horizontal direction.
 Robust housing with high quality silicon, UV proof for true outdoor application.



Correct bending way

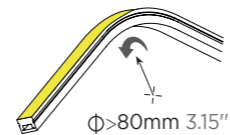

Accessories



2700K 3000K 4000K 6000K

Technical Details 16x16mm White 16W

Product NO.	FEN16W-P7-G1 28BL9x 24V160S8 1616L05			
Voltage	DC24V			
Power	16W/M 4.87W/ft			
CRI	90 (2835LEDs)			
Led Qty	160LEDs/M 48LEDs/ft			
Cutting Length	50mm 1.97"			
IP Grade	IP67			
Length/Reel	5050mm 16.56ft			
Color temperature	● 2700K	● 3000K	● 4000K	○ 6000K
Lumens	1380lm/m 420lm/ft	1410lm/m 430lm/ft	1520lm/m 463lm/ft	1520lm/m 463lm/ft

End cap

Ordinary End Cap

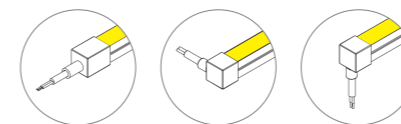

Mold end cap

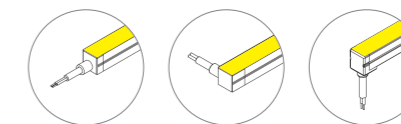

Injection-moulded endcap

*Cable can be bented to any direction.

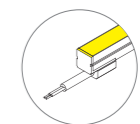

Dimension

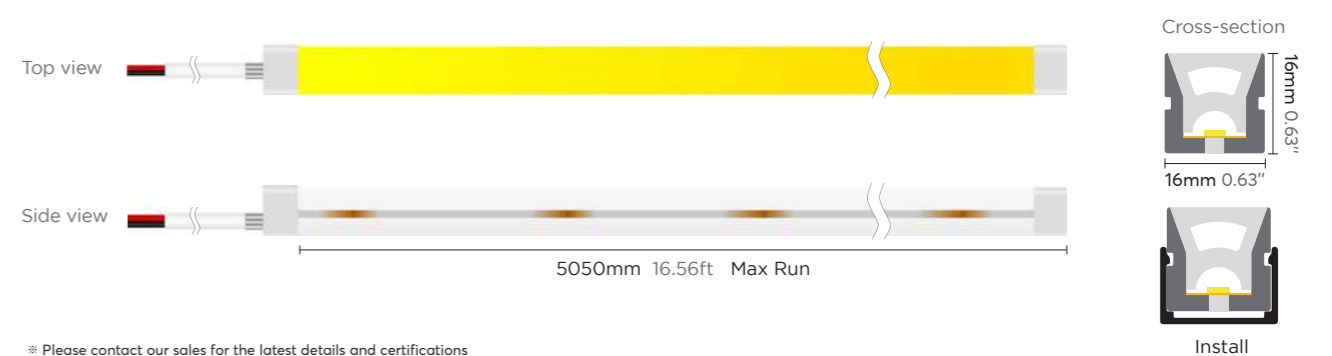

* Please contact our sales for the latest details and certifications

Top bending



Rainbow NEON Customize color

16x16mm

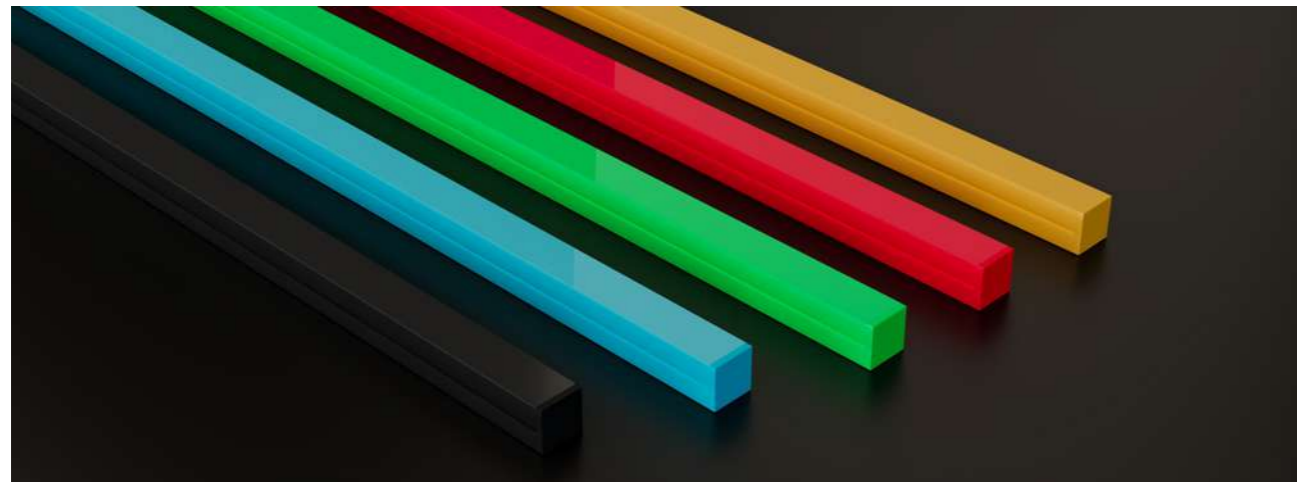

Customizable colors make it more adaptable to various application scenarios, creating a personalized user experience.



Correct bending way

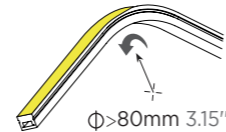

Accessories



Technical Details **Rainbow NEON 16x16mm White 16W**

Product NO.	FEN16W-P7-G1 28HZ9x 24V140S7 1616L05		
Voltage	DC24V		
Power	16W/M 4.87W/ft		
CRI	90 (2835LEDs)		
Led Qty	140LEDs/M 42LEDs/ft		
Cutting Length	50mm 1.97"		
IP Grade	IP67		
Length/Reel	5050mm 16.56ft		
Color temperature	● Champagne	● Grey	● Black
Lumens	600lm/m 182lm/ft	510lm/m 155lm/ft	80lm/m 24lm/ft

End cap

Ordinary End Cap

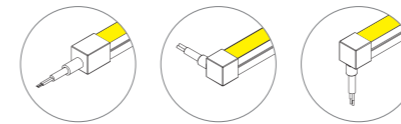

Mold end cap

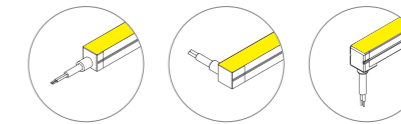

Injection-moulded endcap

*Cable can be bended to any direction.

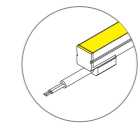

Dimension

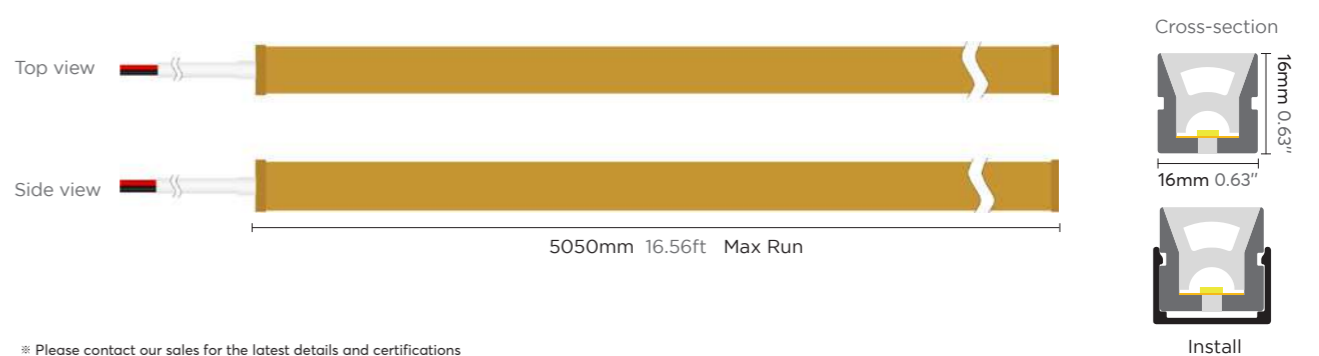

* Please contact our sales for the latest details and certifications

Top bending



16x20mm

WHITE / 12W RGBW / 14W



Seamless and uniform light output, dot free.
 Bendable at horizontal direction.
 IP67 protection.
 Robust housing with high quality silicon, UV proof for true outdoor application.

Correct bending way

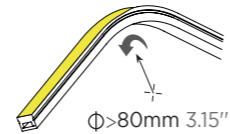

Accessories

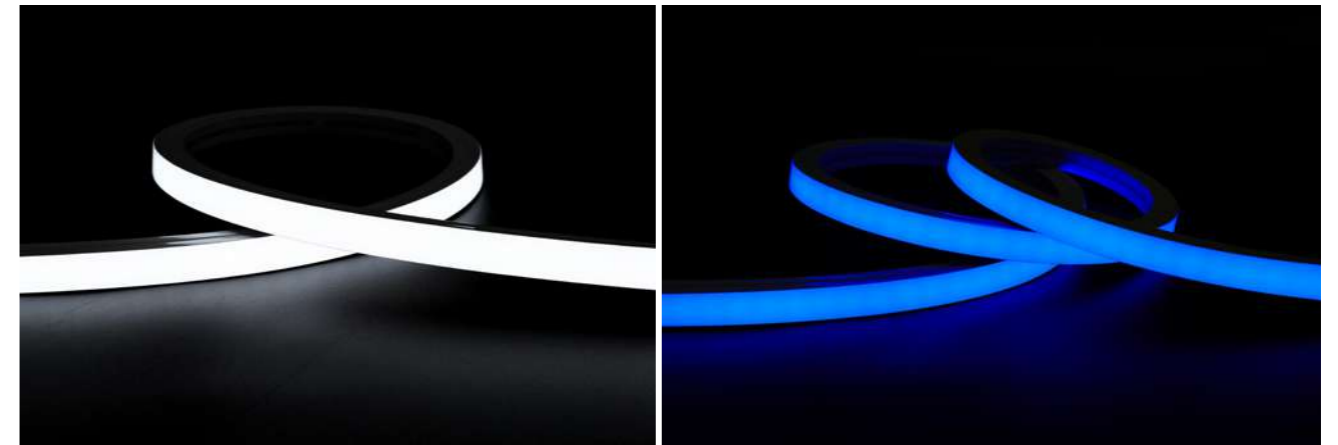

2700K 3000K 4000K 6000K



Technical Details 16x20mm White 12W

Product NO.	FEN12W-P7-G1 28LZ9x 24V120S 1620L05	FEN14C-P7-G1 50ZRGB8x 24V96S 1620L05
Voltage	DC24V	DC24V
Power	12W/M 3.66W/ft	14W/M 4.27W/ft
CRI	90 (2835LEDs)	/(5050LEDs)
Led Qty	120LEDs/M 36LEDs/ft	96LEDs/M 29LEDs/ft
Cutting Length	50mm 1.97"	62.5mm 2.46"
IP Grade	IP67	IP67
Length/Reel	5050mm 16.56ft	5050mm 16.56ft
Color temperature	<input checked="" type="radio"/> 2700K <input checked="" type="radio"/> 3000K <input checked="" type="radio"/> 4000K <input type="radio"/> 6000K	<input checked="" type="radio"/> R <input checked="" type="radio"/> G <input checked="" type="radio"/> B <input type="radio"/> 6000K
Lumens	420lm/m 128lm/ft 450lm/m 137lm/ft 480lm/m 146lm/ft 480lm/m 146lm/ft	60lm/m 18lm/ft 175lm/m 53lm/ft 40lm/m 12lm/ft 150lm/m 46lm/ft

End cap

Ordinary End Cap

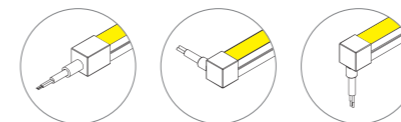

Dimension



* Please contact our sales for the latest details and certifications

Top bending



20x20mm

WHITE / 14W

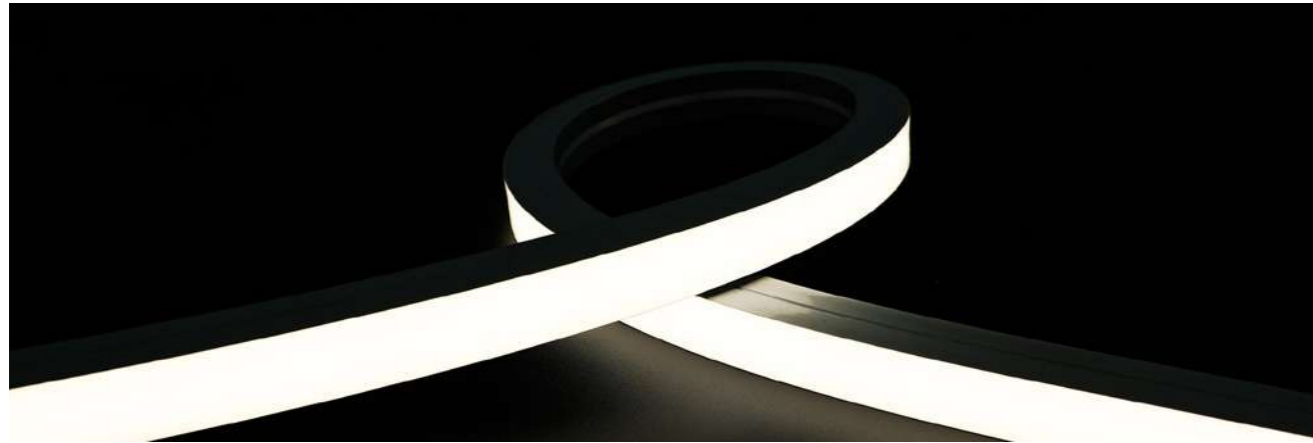

Seamless and uniform light output, dot free.
 Bendable at horizontal direction.
 IP67 protection.
 Robust housing with high quality silicon, UV proof for true outdoor application.

Correct bending way



Accessories



2700K 3000K 4000K 6000K

Technical Details **20x20mm White 14W**

Product NO.	FEN14W-P7-G1 28HZ9x 24V120S 2020L05			
Voltage	DC24V			
Power	14W/M 4.26W/ft			
CRI	90 (2835LEDs)			
Led Qty	120LEDs/M 36LEDs/ft			
Cutting Length	50mm 1.97"			
IP Grade	IP67			
Length/Reel	5050mm 16.56ft			
Color temperature	● 2700K	● 3000K	● 4000K	○ 6000K
Lumens	670lm/m 204lm/ft	670lm/m 204lm/ft	690lm/m 210lm/ft	690lm/m 210lm/ft

End cap

Ordinary End Cap

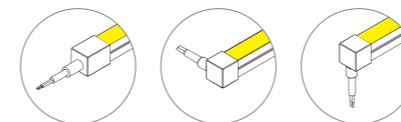

Dimension

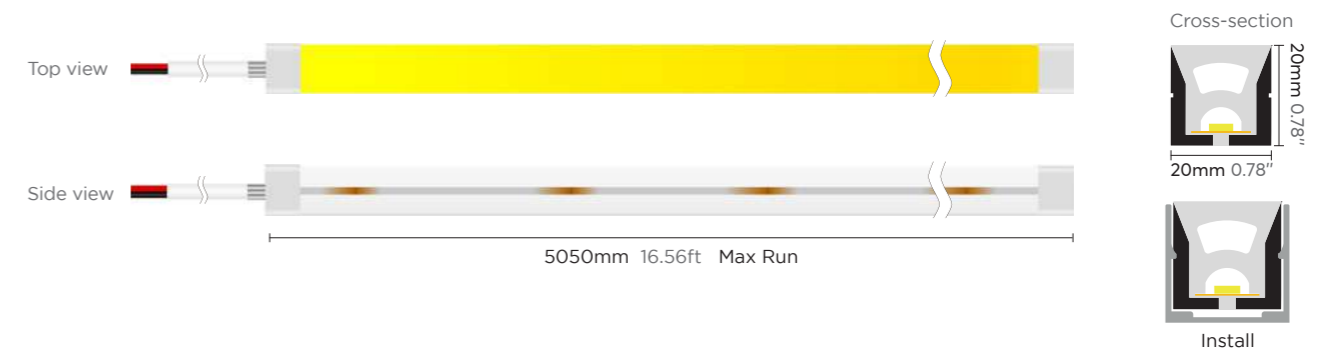

* Please contact our sales for the latest details and certifications

Top bending



25x25mm

White / 16W



Seamless and uniform light output, dot free.
 Bendable at horizontal direction.
 IP67 protection.
 Robust housing with high quality silicon, UV proof for true outdoor application.

Correct bending way



Accessories



2700K 3000K 4000K 6000K

Technical Details 25x25mm White 16W

Product NO.	FEN16W-P7-G1 28HZ9x 24V120S 2525L05			
Voltage	DC24V			
Power	16W/M 4.87W/ft			
CRI	90 (2835LEDs)			
Led Qty	120LEDs/M 36LEDs/ft			
Cutting Length	50mm 1.97"			
IP Grade	IP67			
Length/Reel	5050mm 16.56ft			
Color temperature	● 2700K	● 3000K	● 4000K	○ 6000K
Lumens	620lm/m 189lm/ft	620lm/m 189lm/ft	630lm/m 192lm/ft	630lm/m 192lm/ft

End cap

Ordinary End Cap

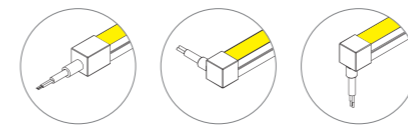

Injection-moulded endcap

*Cable can be bended to any direction.

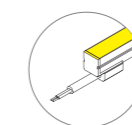

Dimension



** Please contact our sales for the latest details and certifications

Top bending



30x17mm

White / 20W



Seamless and uniform light output, dot free.
 Bendable at horizontal direction.
 IP67 protection.
 Robust housing with high quality silicon, UV proof for true outdoor application.

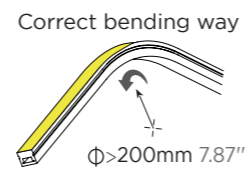

Accessories



2700K 3000K 4000K 6000K

Technical Details 30x17mm White 20W

Product NO.	FEN20W-P7-G1 28HZ9x 24V280D14 3017L05			
Voltage	DC24V			
Power	20W/M 6.1W/ft			
CRI	90 (2835LEDs)			
Led Qty	280LEDs/M 85LEDs/ft			
Cutting Length	50mm 1.97"			
IP Grade	IP67			
Length/Reel	5050mm 16.56ft			
Color temperature	● 2700K	● 3000K	● 4000K	○ 6000K
Lumens	1300lm/m 396lm/ft	1380lm/m 420lm/ft	1480lm/m 451lm/ft	1480lm/m 451lm/ft

End cap

Ordinary End Cap

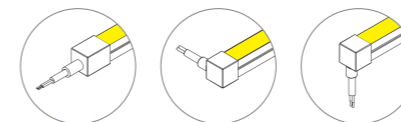

Dimension

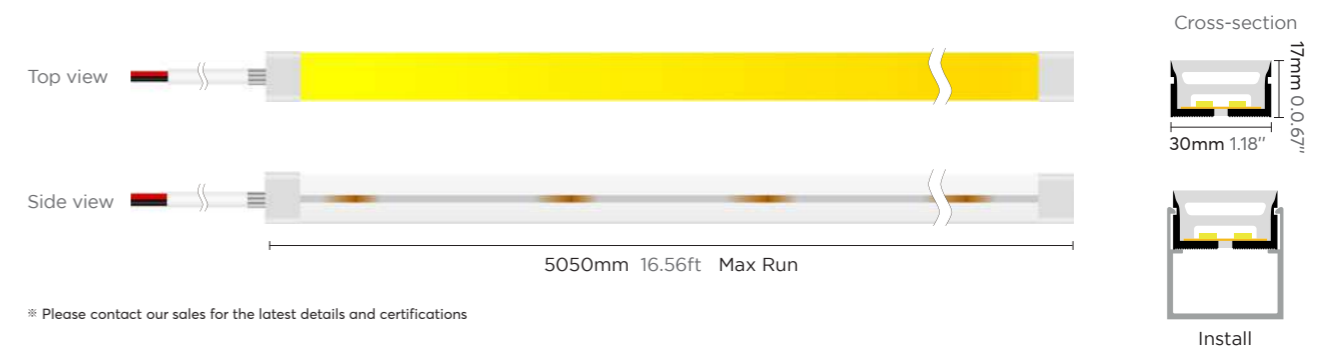

* Please contact our sales for the latest details and certifications

Side bending



6x12mm

WHITE / RGB



6mm light-emitting surface, uniform light, dot free.
 Side emitting, meet a variety of side bending light shape.
 Robust housing with high quality silicon, UV proof for true outdoor application.
 Easy installation with clips and bendable track.
 Cutable for flexible application.

Correct bending way

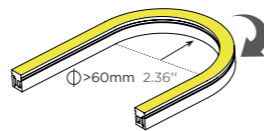

Accessories

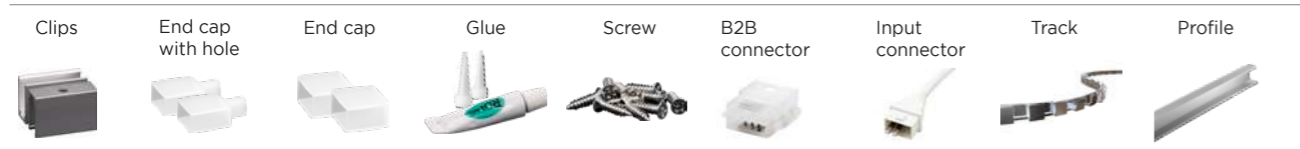

2700K 3000K 4000K 6000K



Technical Details 6x12mm White 10W

Product NO.	FEN10WS-P7-G1 28HZ9x 24V140S7 0612L05
Voltage	DC24V
Power	10W/M 3.04W/ft
CRI	90 (2835LEDs)
Led Qty	140LEDs/M 42LEDs/ft
Cutting Length	50mm 1.97"
IP Grade	IP67
Length/Reel	5050mm 16.56ft
Color temperature	<input checked="" type="radio"/> 2700K <input type="radio"/> 3000K <input type="radio"/> 4000K <input type="radio"/> 6000K
Lumens	280lm/m 85lm/ft 280lm/m 85lm/ft 285lm/m 87lm/ft 285lm/m 87lm/ft

6x12mm RGB 10W

Product NO.	FEN10CS-P7-G1 38XRGB 24V120S 0612L05
Voltage	DC24V
Power	10W/M 3.04W/ft
CRI	- (3838LEDs)
Led Qty	120LEDs/M 36LEDs/ft
Cutting Length	50mm 1.97"
IP Grade	IP67
Length/Reel	5050mm 16.56ft
Color temperature	<input checked="" type="radio"/> R <input checked="" type="radio"/> G <input checked="" type="radio"/> B
Lumens	36lm/m 11lm/ft 100lm/m 30lm/ft 22lm/m 7lm/ft

End cap

Ordinary End Cap

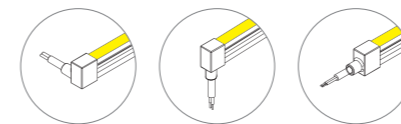

Mold end cap

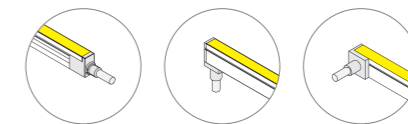

Injection-moulded endcap

*Cable can be bented to any direction.

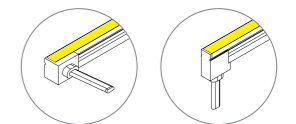

Dimension

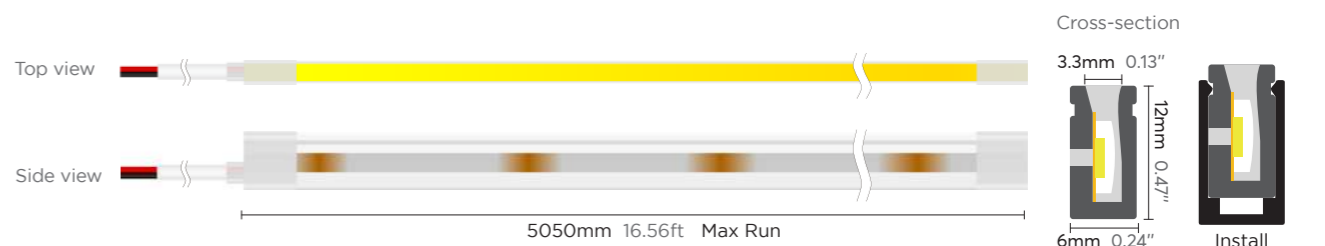

* Please contact our sales for the latest details and certifications

Side bending



8x16mm

WHITE / RGB



Three-sided luminous, wide angle, uniform light, dot free.
 Bendable at horizontal direction.
 Robust housing with high quality silicon, UV proof for true outdoor application.
 Easy installation with clips and bendable track.
 Cut-able for flexible application.



Correct bending way

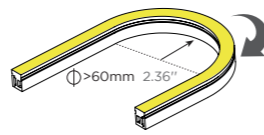

Accessories

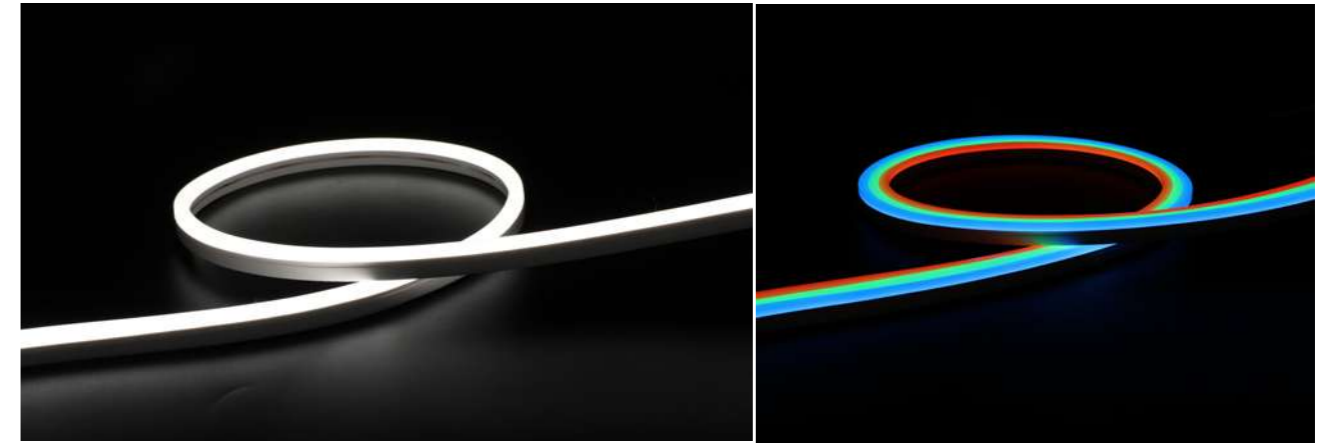

2700K 3000K 4000K 6000K



Technical Details **8x16mm White 12W**

8x16mm RGB 12W

Product NO.	FEN12WS-P7-G1 28HZ9x 24V140S7 0816L05	FEN12CS-P7-G1 38XRGB 24V120S 0816L05
Voltage	DC24V	DC24V
Power	12W/M 3.65W/ft	12W/M 3.65W/ft
CRI	90 (2835LEDs)	- (3838LEDs)
Led Qty	140LEDs/M 42LEDs/ft	120LEDs/M 36LEDs/ft
Cutting Length	50mm 1.97"	50mm 1.97"
IP Grade	IP67	IP67
Length/Reel	5050mm 16.56ft	5050mm 16.56ft
Color temperature	● 2700K ● 3000K ● 4000K ○ 6000K	● R ● G ● B
Lumens	495lm/m 151lm/ft 500lm/m 152lm/ft 535lm/m 163lm/ft 535lm/m 163lm/ft	43lm/m 13lm/ft 122lm/m 37lm/ft 26lm/m 8lm/ft

End cap

Ordinary End Cap

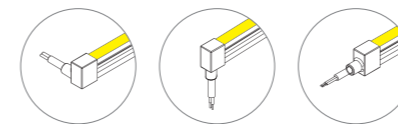

Mold end cap

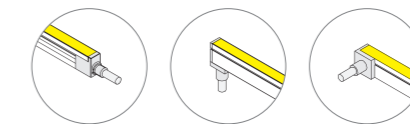

Injection-moulded endcap

*Cable can be bented to any direction.

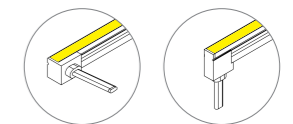

Dimension



※ Please contact our sales for the latest details and certifications

Side bending



10x18mm

White / Tunable CCT



10mm light-emitting surface, uniform light, dot free.
 White Side emitting, meet a variety of side bending light shape.
 IP67, achieve temporary immersion.
 With high quality silicon, UV proof for outdoor application.



Correct bending way

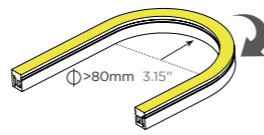

Accessories



2700K 3000K 4000K 6000K



Technical Details 10x18mm White 14W

10x18mm 19W Tunable CCT

Product NO.	FEN14WS-P7-G1 28HZ9x 24V140S7 1018L05	FEN19CS-P7-G1 28HZ92728HZ960 24V240S 1018L05
Voltage	DC24V	DC24V
Power	14.4W/M 4.39W/ft	19.2W/M 5.85W/ft
CRI	90 (2835LEDs)	90 (2835LEDs)
Led Qty	140LEDs/M 42LEDs/ft	240LEDs/M 73LEDs/ft
Cutting Length	50mm 1.97"	50mm 1.97"
IP Grade	IP67	IP67
Length/Reel	5050mm 16.56ft	5050mm 16.56ft
Color temperature	● 2700K ● 3000K ● 4000K ○ 6000K	● 2700K ○ 6000K
Lumens	560lm/m 170lm/ft 565lm/m 172lm/ft 565lm/m 172lm/ft 565lm/m 172lm/ft	350lm/m 106lm/ft 380lm/m 115lm/ft

End cap

Ordinary End Cap

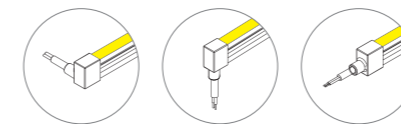

Mold end cap

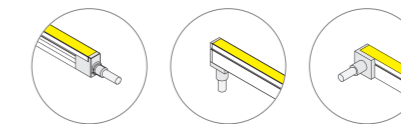

Injection-moulded endcap

*Cable can be bent to any direction.

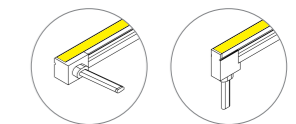

Dimension

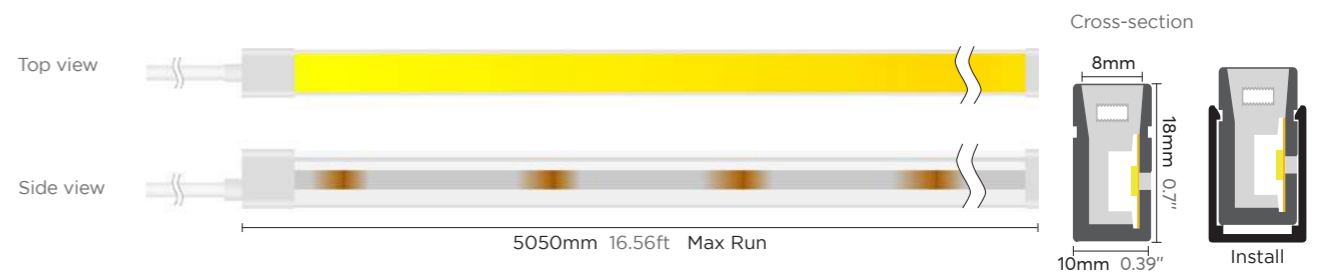

** Please contact our sales for the latest details and certifications

Side bending



220V High voltage NEON

10x18mm

White / Tunable CCT



220V High voltage NEON.
Stable and good quality High-Voltage
Linear constant current solution.
Ultra-long, up to 25 meters one end feed. side bending light shape.
IP65, achieve temporary immersion.



Correct bending way

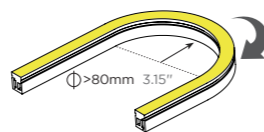

Accessories

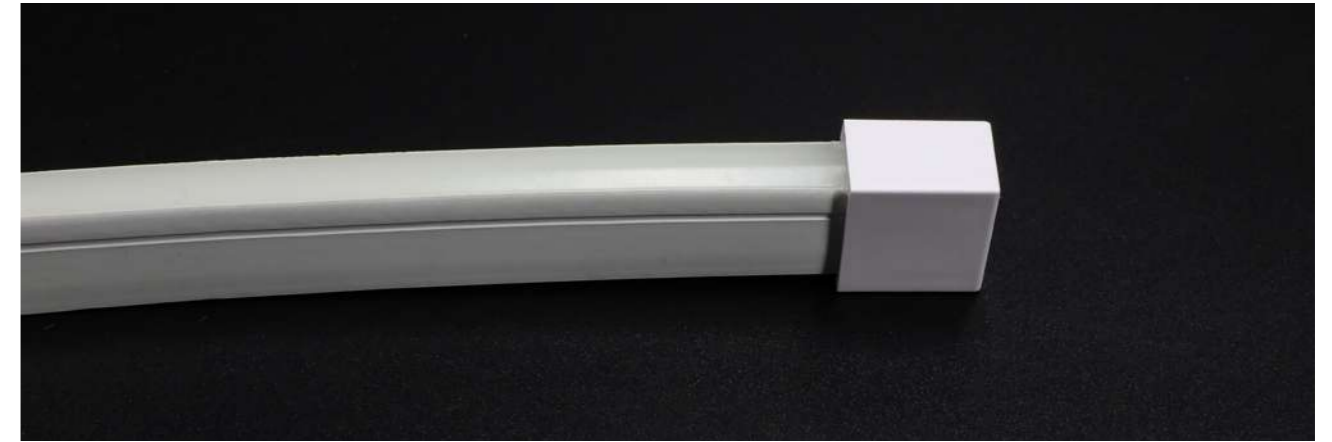

2700K 3000K 4000K 6000K

Technical Details 10x18mm White 14W

Product NO.	FEN14WS-P7-G1 28HZ9x 24V140S7 1018L05
Voltage	DC220V
Power	14.4W/M 4.39W/ft
CRI	90 (2835LEDs)
Led Qty	140LEDs/M 42LEDs/ft
Cutting Length	100mm 3.94"
IP Grade	IP65
Length/Reel	25m 82.02ft
Color temperature	● 2700K ● 3000K ● 4000K ○ 6000K
Lumens	490lm/m 530lm/m 560lm/m 560lm/m

End cap

Ordinary End Cap

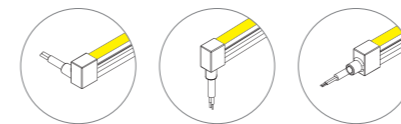

Dimension



Side bending



10x18mm

RGB / RGBW



Seamless and uniform light output, dot free Bendable at horizontal direction.
Robust housing with high quality silicon, UV proof for true outdoor application.
Cut-able for flexible application, easy installation with clips and bendable track.
4 in 1, can achieve a variety of colors.



Correct bending way

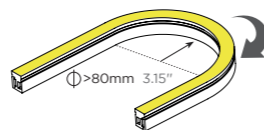

Accessories

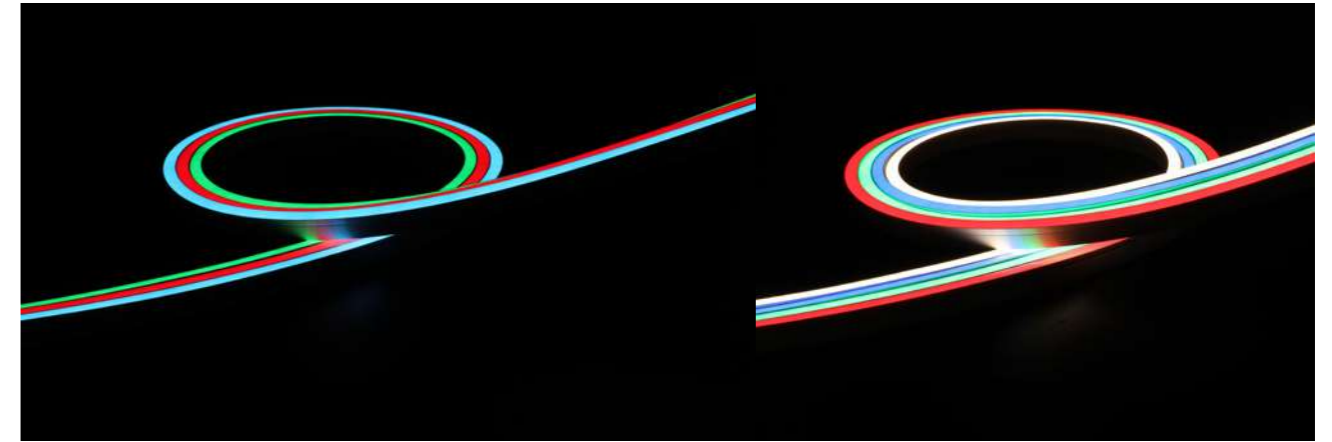

Technical Details 10x18mm RGB 14W

10x18mm 14W RGBW

Product NO.	FEN14CS-P7-G1 50ZRGB 24V60S 1018L05	FEN14CS-P7-G1 50ZRGB8x 24V60S 1018L05
Voltage	DC24V	DC24V
Power	14.4W/M 4.39W/ft	14.4W/M 4.39W/ft
CRI	- (5050LEDs)	80 (5050LEDs)
Led Qty	60LEDs/M 18LEDs/ft	60LEDs/M 18LEDs/ft
Cutting Length	50mm 1.97"	50mm 1.97"
IP Grade	IP67	IP67
Length/Reel	5050mm 16.56ft	5050mm 16.56ft
Lumens		
R	50lm/m 15lm/ft	60lm/m 18lm/ft
G	120lm/m 36lm/ft	120lm/m 36lm/ft
B	30lm/m 9lm/ft	40lm/m 12lm/ft
		3000K 165lm/m 50lm/ft

End cap

Ordinary End Cap

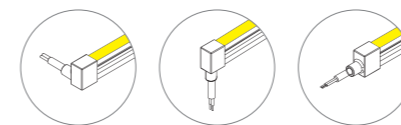

Mold end cap

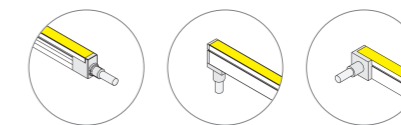

Injection-moulded endcap

*Cable can be bended to any direction.

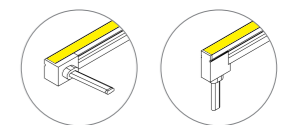

Dimension

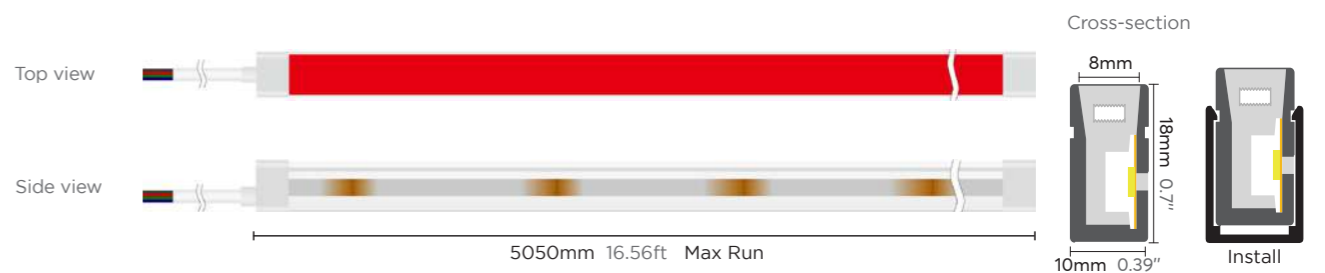

* Please contact our sales for the latest details and certifications

Side bending



12x20mm

WHITE 15W / Tunable CCT 12W



12mm light-emitting surface, uniform light, dot free.
 White Side emitting, meet a variety of side bending light shape.
 IP67, achieve temporary immersion.
 With high quality silicon, UV proof for outdoor application.



Correct bending way

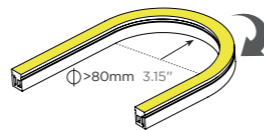

Accessories



2700K 3000K 4000K 6000K



Technical Details 12x20mm White 15W

Product NO.	FEN15WS-P7-G1 28HZ9x 24V120S 1220L05
Voltage	DC24V
Power	15W/M 4.57W/ft
CRI	90 (2835LEDs)
Led Qty	120LEDs/M 36LEDs/ft
Cutting Length	50mm 1.97"
IP Grade	IP67
Length/Reel	5050mm 16.56ft
Color temperature	<input checked="" type="radio"/> 2700K <input type="radio"/> 3000K <input type="radio"/> 4000K <input type="radio"/> 6000K
Lumens	390lm/m 118lm/ft 390lm/m 118lm/ft 400lm/m 121lm/ft 400lm/m 121lm/ft

12x20mm Tunable CCT 12W

Product NO.	FEN12CS-P7-G1 28HZ927 28HZ950 24V112S 1220L05
Voltage	DC24V
Power	12W/M 3.65W/ft
CRI	90 (2835LEDs)
Led Qty	112LEDs/M 34LEDs/ft
Cutting Length	125mm 4.92"
IP Grade	IP67
Length/Reel	5050mm 16.56ft
Color temperature	<input checked="" type="radio"/> 2700K <input type="radio"/> 6000K
Lumens	160lm/m 49lm/ft 180lm/m 55lm/ft

End cap

Ordinary End Cap

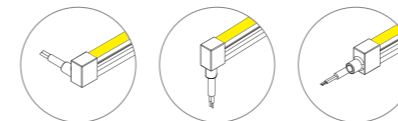

Mold end cap

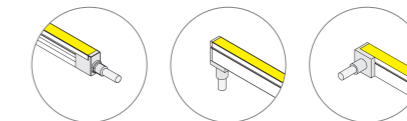

Injection-moulded endcap

*Cable can be bent to any direction.

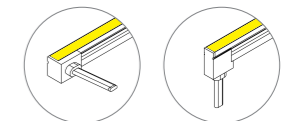

Dimension

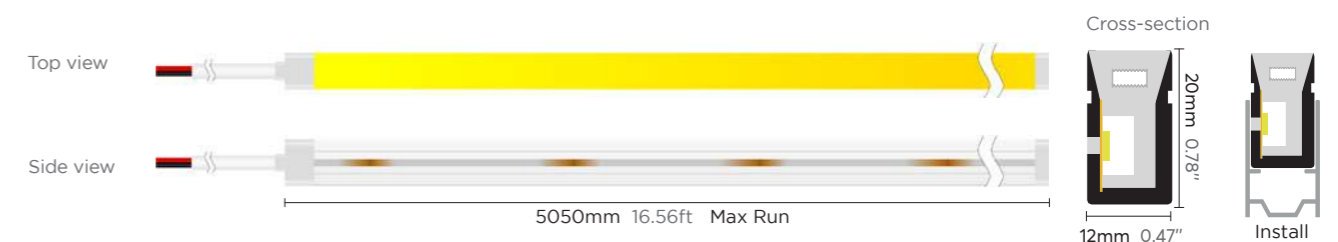

※ Please contact our sales for the latest details and certifications

Side bending



12x25mm

WHITE / 14W



12mm Cambered surface lighting, dot free.
 White side emitting, meet a variety of side bending light shape.
 IP67, achieve temporary immersion.
 With high quality silicon, UV proof for outdoor application.

Correct bending way

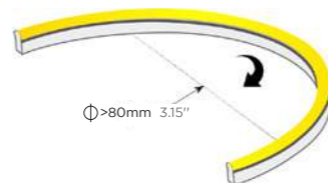

Accessories



2700K 3000K 4000K 6000K

Technical Details 12x25mm White 14W

Product NO.	FEN14WS-P7-G1 28HZ9x 24V120S 1225L05			
Voltage	DC24V			
Power	14W/M 4.26W/ft			
CRI	90 (2835LEDs)			
Led Qty	120LEDs/M 36LEDs/ft			
Cutting Length	50mm 1.97"			
IP Grade	IP67			
Length/Reel	5050mm 16.56ft			
Color temperature	● 2700K	● 3000K	● 4000K	○ 6000K
Lumens	450lm/m 137lm/ft	450lm/m 137lm/ft	460lm/m 140lm/ft	460lm/m 140lm/ft

End cap

Ordinary End Cap

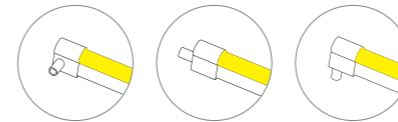

Dimension



※ Please contact our sales for the latest details and certifications

Mini NEON

 Side bending

Free cut 3x8mm

WHITE / 6W

Extrusion process, lights soft and uniform.
3mm wide with ultra narrow output.
Bendable at horizontal direction.
Robust housing with high quality silicon.
Cut-able for flexible application.



NEON SERIES · MINI NEON

Accessories



Correct bending way

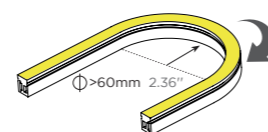

Technical Details 3x8mm White 6W

Product NO.	FEN06WS-P7-G1 22X9x 24V238S1 0308L05			
Voltage	DC24V			
Power	6W/M 1.82W/ft			
CRI	90 (2216LEDs)			
Led Qty	238LEDs/M 73LEDs/ft			
Cutting Length	Free cut (29mm 1.14" Soldering pad distance)			
IP Grade	IP67			
Length/Reel	5050mm 16.56ft			
Color temperature	<input checked="" type="radio"/> 2700K	<input checked="" type="radio"/> 3000K	<input type="radio"/> 4000K	<input type="radio"/> 6000K
Lumens	120lm/m 36lm/ft	125lm/m 38lm/ft	135lm/m 41lm/ft	135lm/m 41lm/ft

End cap

Ordinary End Cap

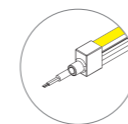

Dimension



* Please contact our sales for the latest details and certifications

NEON SERIES · MINI NEON

Mini NEON

Side bending



Mini cut 3x8mm

WHITE / 6W

- Extrusion process, lights soft and uniform.
- 3mm wide with ultra narrow output.
- Bendable at horizontal direction.
- Robust housing with high quality silicon.
- Cut-able for flexible application.

Accessories



Correct bending way

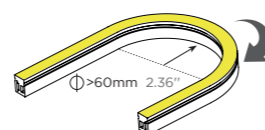

2700K 3000K 4000K 6000K



Technical Details 3x8mm White 6W

Product NO.	FEN06WS-P7-G1 22X9x 24V238S7 0308L05			
Voltage	DC24V			
Power	6W/M 1.82W/ft			
CRI	90 (2216LEDs)			
Led Qty	238LEDs/M 73LEDs/ft			
Cutting Length	29mm (1.14" Cutting Length)			
IP Grade	IP67			
Length/Reel	5050mm 16.56ft			
Color temperature	● 2700K	● 3000K	● 4000K	○ 6000K
Lumens	150lm/m 45lm/ft	160lm/m 48lm/ft	170lm/m 51lm/ft	170lm/m 51lm/ft

End cap

Ordinary End Cap

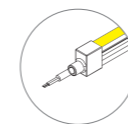

Dimension



* Please contact our sales for the latest details and certifications

Mini NEON

Side bending

4x8mm

WHITE / 6W

Extrusion process, lights soft and uniform.
 3.5mm wide with ultra narrow output.
 Bendable at horizontal direction.
 Robust housing with high quality silicon, UV proof for true outdoor application.
 Cutable for flexible application.



NEON SERIES · MINI NEON

Accessories



Correct bending way

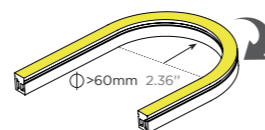

Technical Details 4x8mm White 6W

Product NO.	FEN06WS-P7-G1-28LZ9x 24V180S 0408L05			
Voltage	DC24V			
Power	6W/M 1.82W/ft			
CRI	90 (2835LEDs)			
Led Qty	180LEDs/M 54LEDs/ft			
Cutting Length	33.3mm 1.3"			
IP Grade	IP67			
Length/Reel	5050mm 16.56ft			
Color temperature	<input checked="" type="radio"/> 2700K	<input checked="" type="radio"/> 3000K	<input checked="" type="radio"/> 4000K	<input type="radio"/> 6000K
Lumens	120lm/m 36lm/ft	123lm/m 37lm/ft	126lm/m 38lm/ft	126lm/m 38lm/ft

End cap

Ordinary End Cap

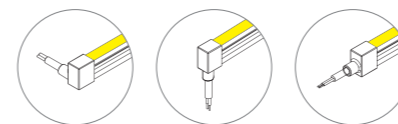

Dimension

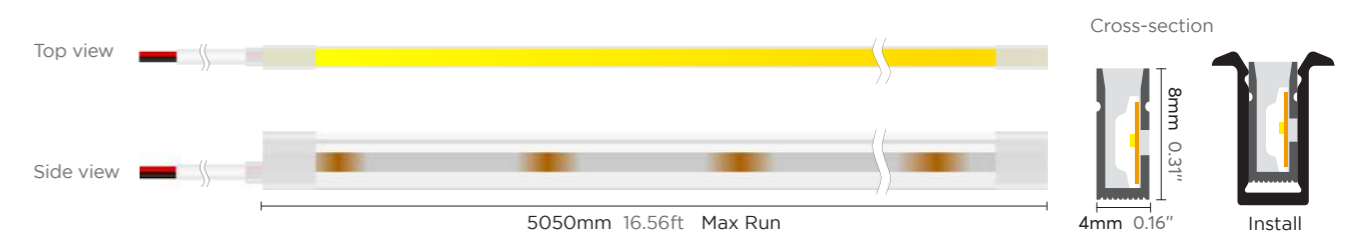

* Please contact our sales for the latest details and certifications

NEON SERIES · MINI NEON

Mini NEON

Side bending

4x10(T)mm

WHITE / 10W

T-Shape



Profile free, perfect fit-in, no gap left.
6mm T-Shape lighting, larger luminous surface, lights soft and uniform.
Bendable at horizontal direction.
Robust housing with high quality silicon, UV proof for true outdoor application.
Cuttable for flexible application.



Correct bending way

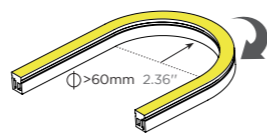

Accessories

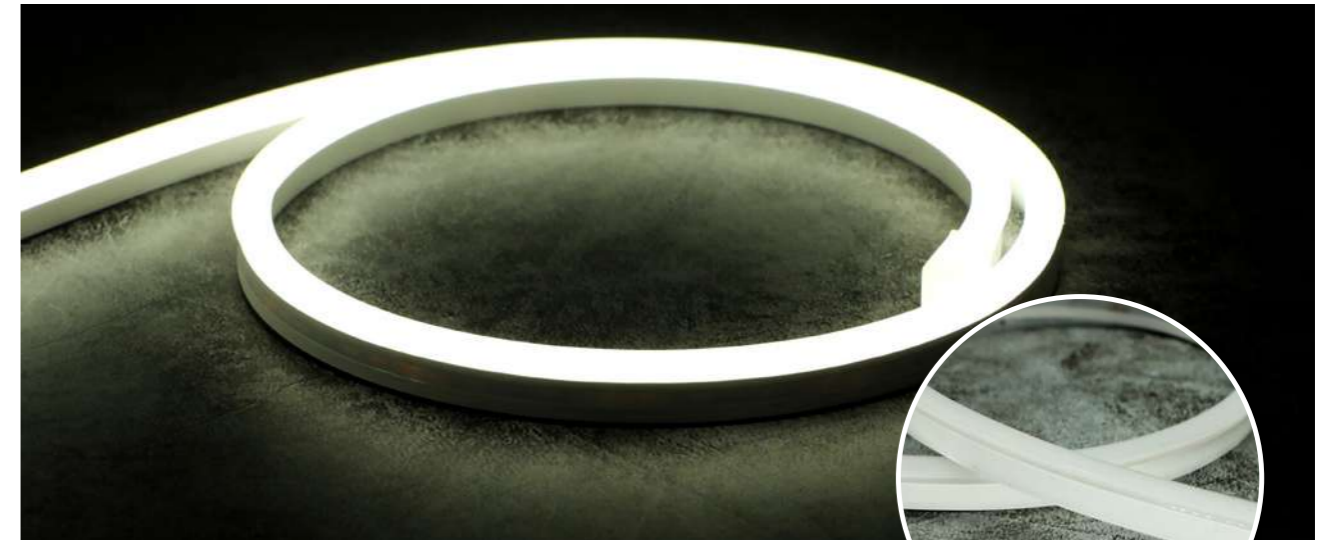

T-Shape lighting

2700K 3000K 4000K 6000K

Technical Details Free Cut 4x10mm 10W

Product NO.	FEN10WS-P7-G1 28AH9x 24V180S1 0410L05 T			
Voltage	DC24V			
Power	10W/M 3.04W/ft			
CRI	90 (2835LEDs)			
Led Qty	180LEDs/M 55LEDs/ft			
Cutting Length	Free cut (33.33mm 1.31" Soldering pad distance)			
IP Grade	IP67			
Length/Reel	5050mm 16.56ft			
Color temperature	<input checked="" type="radio"/> 2700K <input type="radio"/> 3000K <input type="radio"/> 4000K <input type="radio"/> 6000K			
Lumens	260lm/m 79lm/ft	290lm/m 88lm/ft	310lm/m 95lm/ft	310lm/m 95lm/ft

End cap

Ordinary End Cap

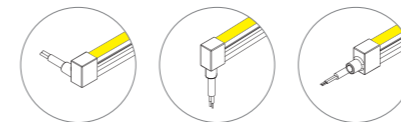

Dimension



* Please contact our sales for the latest details and certifications

Mini NEON

Side bending

4x10(T)mm

WHITE / 10W

T-Shape



Mini cut

6mm T-Shape lighting, larger luminous surface, lights soft and uniform.
 Bendable at horizontal direction.
 Robust housing with high quality silicon, UV proof for true outdoor application.
 Cut-able for flexible application.

Correct bending way

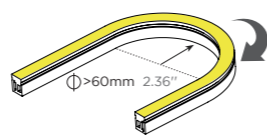

Accessories



T-Shape lighting

2700K 3000K 4000K 6000K

Technical Details	Mini Cut 4x10mm 10W	Mini Cut 4x10mm 10W
Product NO.	FEN10WS-P7-G1 28LZ9x 24V180S 0410L05 T	FEN10WS-P7-G1 28LZ9x 24V182S7 0410L05 T
Voltage	DC24V	DC24V
Power	10W/M 3.04W/ft	10W/M 3.04W/ft
CRI	90 (2835LEDs)	90 (2835LEDs)
Led Qty	180LEDs/M 55LEDs/ft	182LEDs/M 55LEDs/ft
Cutting Length	Mini Cut 33.33mm 1.31"	Mini Cut 38.5mm 1.4"
IP Grade	IP67	IP67
Length/Reel	5050mm 16.56ft	5050mm 16.56ft
Color temperature	● 2700K ● 3000K ● 4000K ○ 6000K	● 2700K ● 3000K ● 4000K ○ 6000K
Lumens	270lm/m 82lm/ft 300lm/m 91lm/ft 320lm/m 98lm/ft 320lm/m 98lm/ft	320lm/m 98lm/ft 360lm/m 110lm/ft 370lm/m 113lm/ft 370lm/m 113lm/ft

End cap

Ordinary End Cap

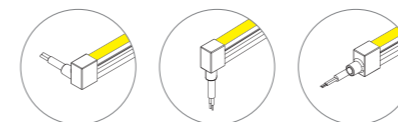

Dimension



* Please contact our sales for the latest details and certifications

Mini NEON

 Side bending

4x10mm

WHITE / 10W



Extrusion process, lights soft and uniform.
3.5mm wide with ultra narrow output.
Bendable at horizontal direction.
Robust housing with high quality silicon, UV proof for true outdoor application.
Cut-able for flexible application.



Correct bending way

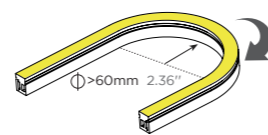

Accessories

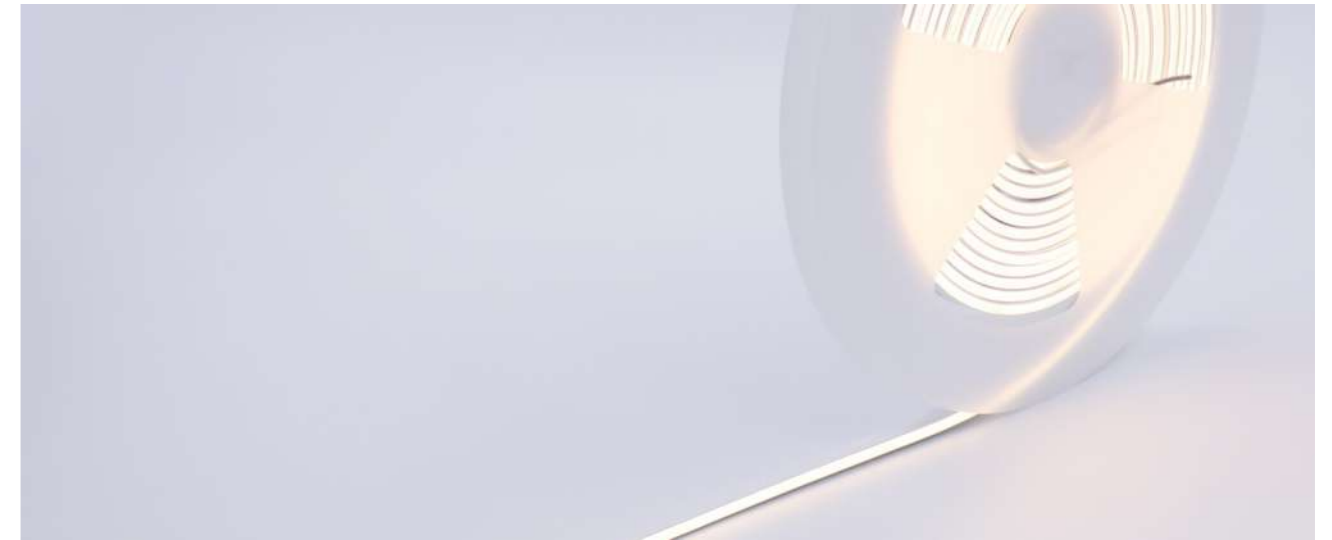

2700K **3000K** **4000K** **6000K**

Technical Details **4x10mm White 10W**

Product NO.	FEN10WS-P7-G1 28LZ9x 24V144S 0410L05			
Voltage	DC24V			
Power	10W/M 3.04W/ft			
CRI	90 (2835LEDs)			
Led Qty	144LEDs/M			
Cutting Length	41.6mm 1.63"			
IP Grade	IP67			
Length/Reel	5050mm 16.56ft			
Color temperature	2700K	3000K	4000K	6000K
Lumens	130lm/m 40lm/ft	150lm/m 46lm/ft	160lm/m 49lm/ft	160lm/m 49lm/ft

End cap

Ordinary End Cap

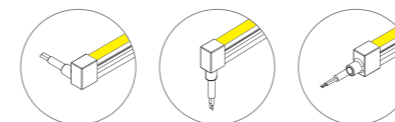

Dimension

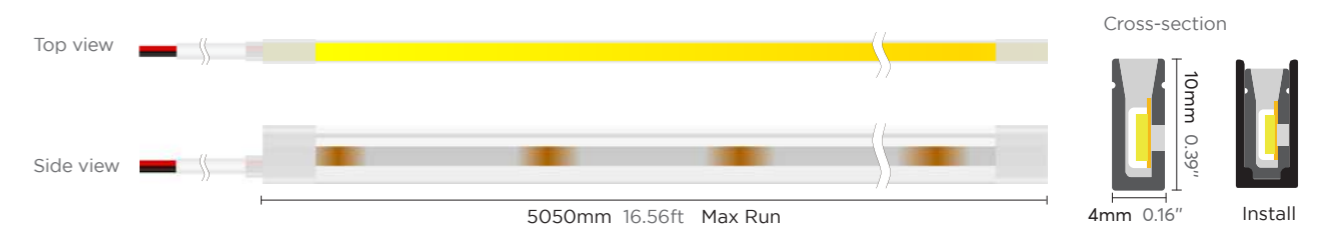

* Please contact our sales for the latest details and certifications

Mini NEON

 Top bending

6x6mm Free cut / Mini cut

WHITE

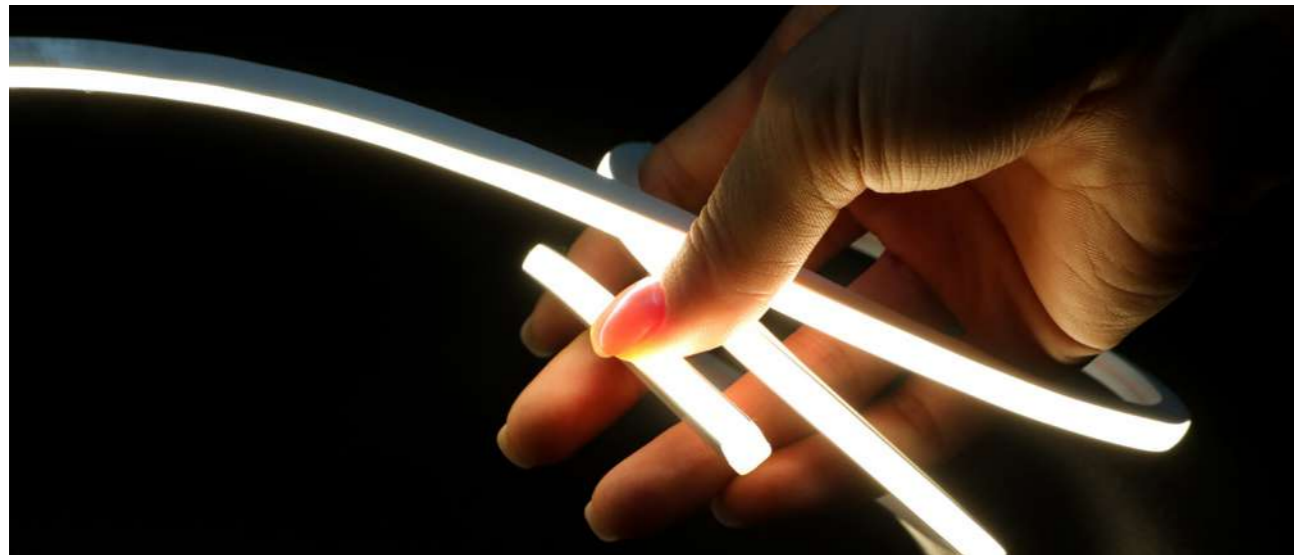

Extrusion process, lights soft and uniform.
6mm wide with ultra narrow output.
Robust housing with high quality silicon.
UV proof for true outdoor application.
Mini Cut 25mm, cuttable for flexible application.

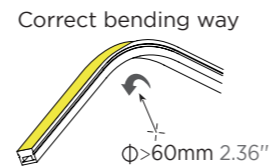

Accessories

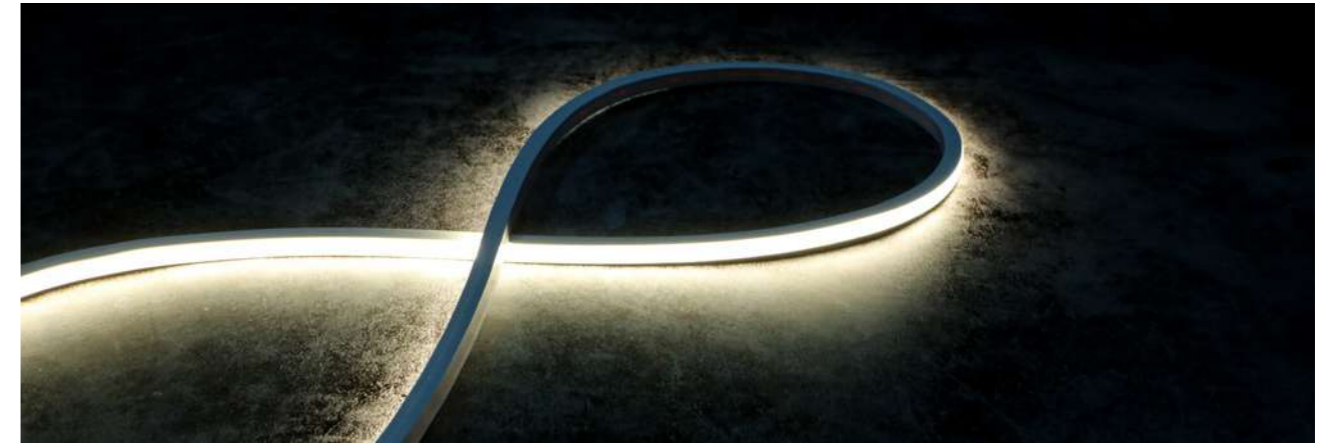

2700K 3000K 4000K 6000K

Technical Details Free Cut 6x6mm 8W

Product NO.	FEN08W-P7-G1 22X9X 24V238S1 0606L05
Voltage	DC24V
Power	8W/M 2.43W/ft
CRI	90 (2216LEDs)
Led Qty	238LEDs/M 72LEDs/ft
Cutting Length	29.4mm 1.16" (Soldering Pad Distance)
IP Grade	IP67
Length/Reel	5050mm 16.56ft
Color temperature	<input checked="" type="radio"/> 2700K <input checked="" type="radio"/> 3000K <input checked="" type="radio"/> 4000K <input type="radio"/> 6000K
Lumens	385lm/m 117lm/ft 390lm/m 119lm/ft 410lm/m 125lm/ft 410lm/m 125lm/ft

Technical Details Mini Cut 6x6mm 8W

Product NO.	FEN08W-P7-G1 22X9X 24V238S7 0606L05
Voltage	DC24V
Power	8W/M 2.43W/ft
CRI	90 (2835LEDs)
Led Qty	2216LEDs/M 55LEDs/ft
Cutting Length	Mini Cut 29.4mm 1.16"
IP Grade	IP67
Length/Reel	5050mm 16.56ft
Color temperature	<input checked="" type="radio"/> 2700K <input checked="" type="radio"/> 3000K <input checked="" type="radio"/> 4000K <input type="radio"/> 6000K
Lumens	480lm/m 146lm/ft 490lm/m 149lm/ft 510lm/m 155lm/ft 510lm/m 155lm/ft

End cap

Ordinary End Cap

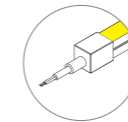

Dimension

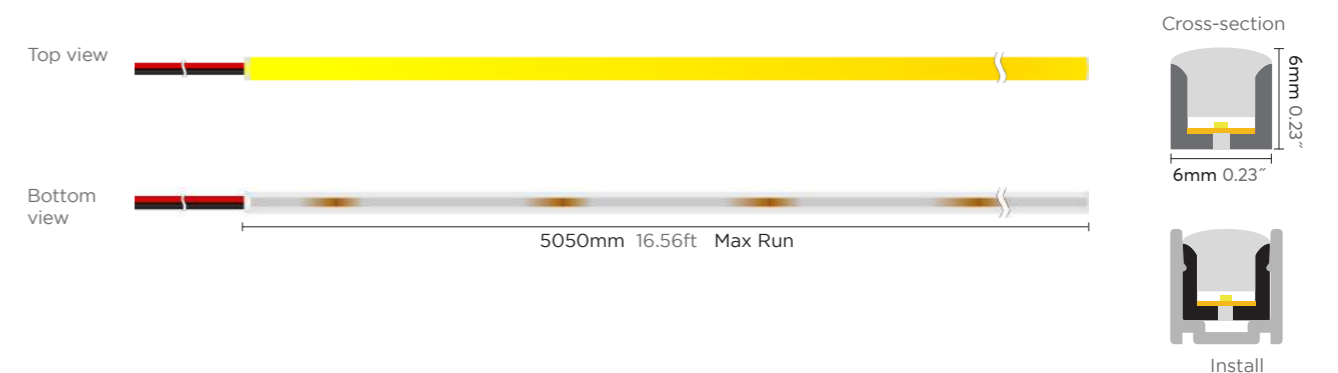

※ Please contact our sales for the latest details and certifications

Long-Run NEON



Side bending

Up to 10m

6x12mm

White



6mm light-emitting surface, uniform light, dot free.
 Side emitting, meet a variety of side bending light shape.
 Robust housing with high quality silicon, UV proof for true outdoor application.
 Easy installation with clips and bendable track.
 Cutable for flexible application.

Correct bending way

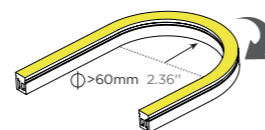

2700K 3000K 4000K 6000K

Technical Details **6x12mm White 5W**

Product NO.	FEN05WS-P7-G1 28HZ9x 24V120S 0612L10			
Voltage	DC24V			
Power	4.8W/M 1.46W/ft			
CRI	90 (2835LEDs)			
Led Qty	120LEDs/M 36LEDs/ft			
Cutting Length	50mm 1.97"			
IP Grade	IP67			
Length/Reel	10m 32.81ft			
Color temperature	● 2700K ● 3000K ● 4000K ○ 6000K			
Lumens	135lm/m 41lm/ft	145lm/m 44lm/ft	150lm/m 46lm/ft	145lm/m 44lm/ft

End cap

Ordinary End Cap

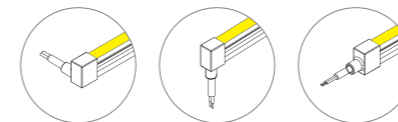

Mold end cap

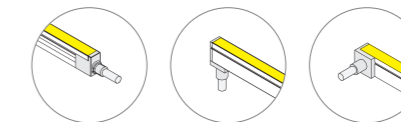

Injection-moulded endcap

*Cable can be bended to any direction.

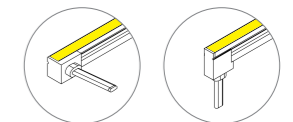

Dimension

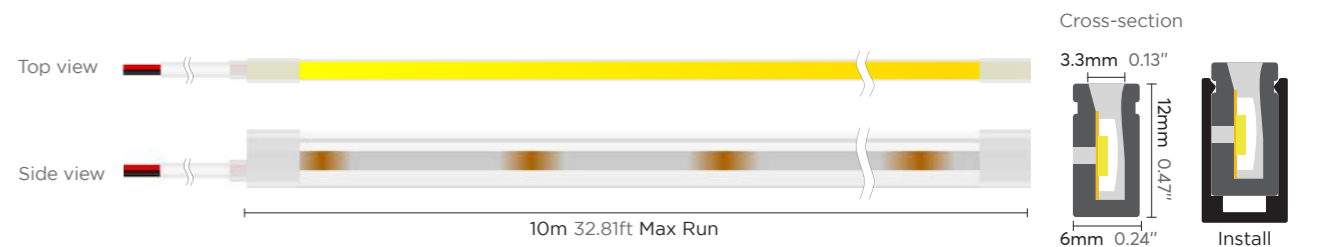

* Please contact our sales for the latest details and certifications

Accessories

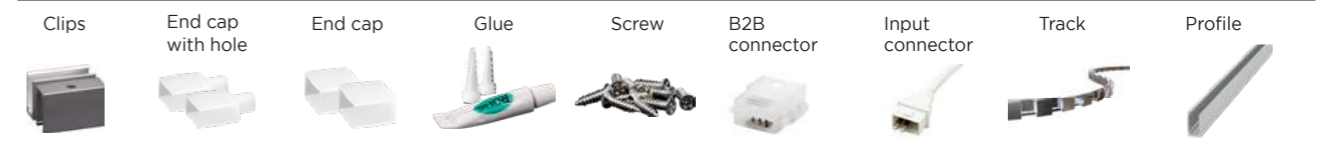

Long-Run NEON



Side bending

Up to 20m 10x18mm

White/RGB



10mm light-emitting surface, uniform light, dot free.
White Side emitting, meet a variety of side bending light shape.
IP67, achieve temporary immersion.
With high quality silicon, UV proof for outdoor application.

Correct bending way

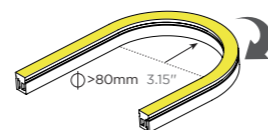

2700K 3000K 4000K 6000K



Technical Details **10x18mm 20m White 10W**

10x18mm 10m 10W RGB

Product NO.	FEN10WS-P7-G1 28HZ9x 24VC120S 1018L20	FEN10CS-P7-G1 50ZRGB 24VC60S 1018L10
Voltage	DC24V	DC24V
Power	9.6W/M 2.93W/ft	9.6W/M 2.93W/ft
CRI	90 (2835LEDs)	/ (5050LEDs)
Led Qty	120LEDs/M 36LEDs/ft	60LEDs/M 18LEDs/ft
Cutting Length	50mm 1.97"	100mm 3.94"
IP Grade	IP67	IP67
Length/Reel	20m 65.62ft	10m 32.8ft
Lumens		
● 2700K	240lm/m 73lm/ft	● R 35lm/m 11lm/ft
● 3000K	260lm/m 79lm/ft	● G 90lm/m 27lm/ft
● 4000K	290lm/m 88lm/ft	● B 22lm/m 7lm/ft
○ 6000K	290lm/m 88lm/ft	

End cap

Ordinary End Cap

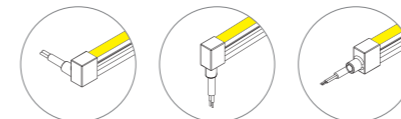

Mold end cap

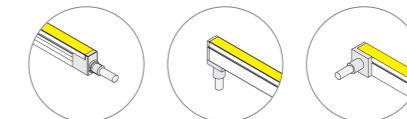

Injection-moulded endcap

*Cable can be bended to any direction.

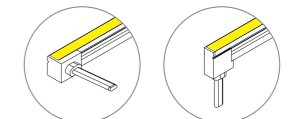

Dimension



* Please contact our sales for the latest details and certifications

Long-Run NEON



Side bending

Up to 20m

12x20mm

White



12mm light-emitting surface, uniform light, dot free.
 White Side emitting, meet a variety of side bending light shape.
 IP67, achieve temporary immersion.
 With high quality silicon, UV proof for outdoor application.



Correct bending way

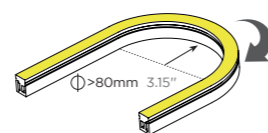

2700K 3000K 4000K 6000K

Technical Details **12x20mm 20m White 10W**

Product NO.	FEN10WS-P7-G2 28LZ9x 24VT120S 1220L20			
Voltage	DC24V			
Power	9.6W/M 2.93W/ft			
CRI	90 (2835LEDs)			
Led Qty	120LEDs/M 36LEDs/ft			
Cutting Length	50mm 1.97"			
IP Grade	IP67			
Length/Reel	20m 65.62ft			
Color temperature	<input checked="" type="radio"/> 2700K <input checked="" type="radio"/> 3000K <input checked="" type="radio"/> 4000K <input type="radio"/> 6000K			
Lumens	260lm/m 79lm/ft	285lm/m 87lm/ft	310lm/m 95lm/ft	310lm/m 95lm/ft

End cap

Ordinary End Cap

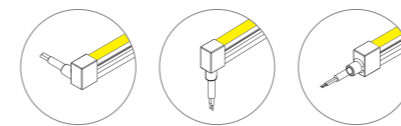

Mold end cap

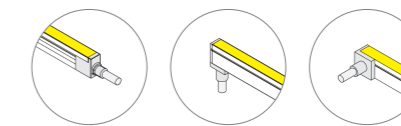

Injection-moulded endcap

*Cable can be bent to any direction.

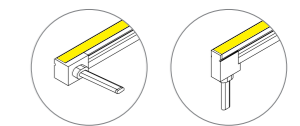

Dimension

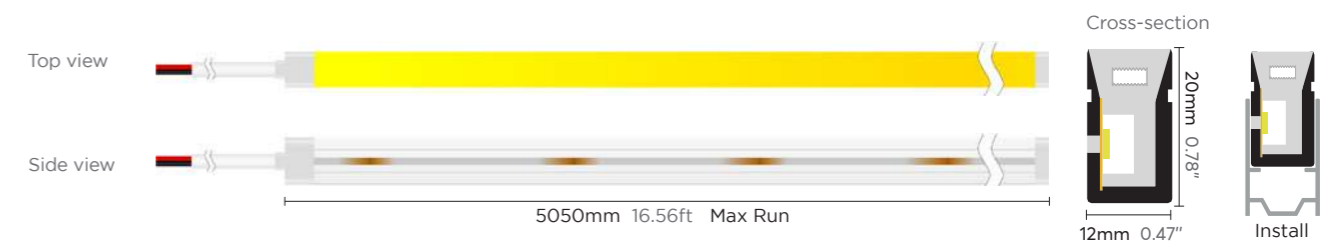

Accessories



※ Please contact our sales for the latest details and certifications

Long-Run NEON



Top bending

Up to 20m

16x16mm

White



Ultra-Long, up to 20m.

Seamless and uniform light output, dot free, bendable at horizontal direction.

IP67 protection, robust housing with high quality silicon, uv proof for true outdoor application.

Single power supply 20 meters, easy to connect and install.



Correct bending way

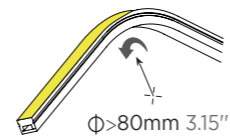

Accessories



2700K 3000K 4000K 6000K

Technical Details 16x16mm 20m White 10W

Product NO.	FEN10W-P7-G2 28LZ9x 24VT120S 1616L20
Voltage	DC24V
Power	10W/M 3.05W/ft
CRI	90 (2835LEDs)
Led Qty	120LEDs/M 36LEDs/ft
Cutting Length	50mm 1.97"
IP Grade	IP67
Length/Reel	20m 65.62ft
Color temperature	● 2700K ● 3000K ● 4000K ○ 6000K
Lumens	480lm/m 530lm/m 560lm/m 560lm/m 146lm/ft 162lm/ft 170lm/ft 170lm/ft

16x16mm 20m White 15W

Product NO.	FEN15W-P7-G2 28HZ9x 24VT120S 1616L20
Voltage	DC24V
Power	15W/M 4.57W/ft
CRI	90 (2835LEDs)
Led Qty	120LEDs/M 36LEDs/ft
Cutting Length	50mm 1.97"
IP Grade	IP67
Length/Reel	20m 65.62ft
Color temperature	● 2700K ● 3000K ● 4000K ○ 6000K
Lumens	865lm/m 880lm/m 900lm/m 900lm/m 264lm/ft 268lm/ft 274lm/ft 274lm/ft

End cap

Ordinary End Cap

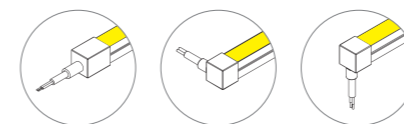

Mold end cap

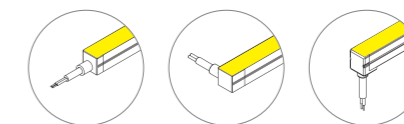

Injection-moulded endcap
*Cable can be bended to any direction.

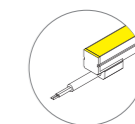

Dimension



* Please contact our sales for the latest details and certifications

Long-Run NEON



Top bending

Up to 30m

16x16mm

White

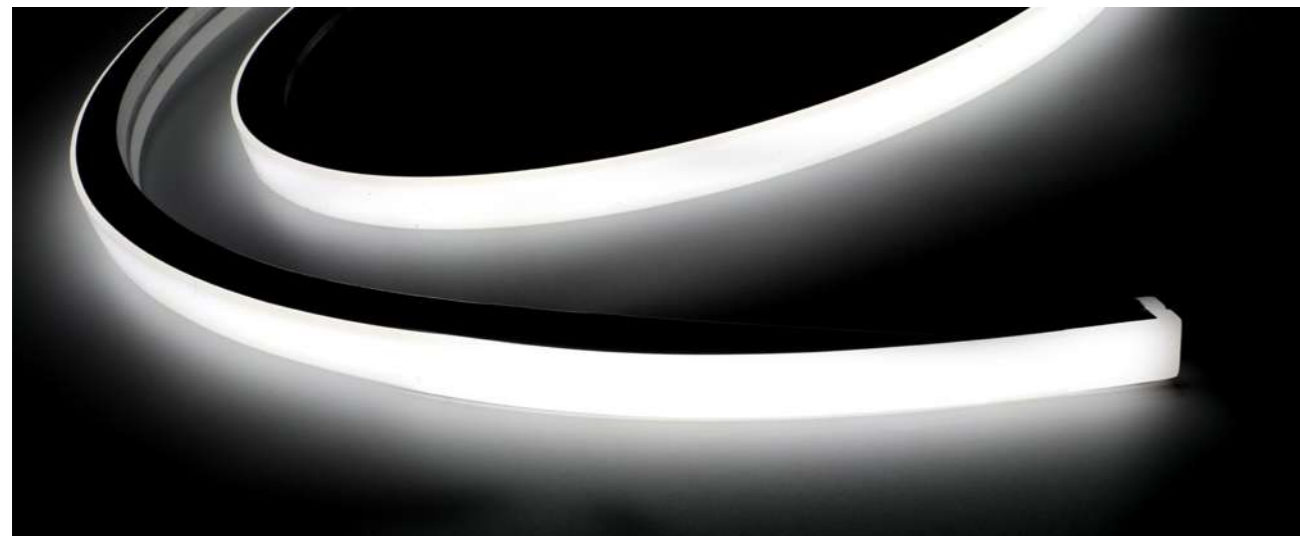

Ultra-Long, up to 30m.

Seamless and uniform light output, dot free, bendable at horizontal direction.

IP67 protection, robust housing with high quality silicon, uv proof for true outdoor application.

Single power supply 20 meters, easy to connect and install.



Correct bending way

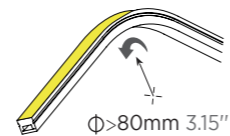

Accessories



2700K 3000K 4000K 6000K

Technical Details **16x16mm 30m White 6W**

Product NO.	FEN06W-P7-G2 28LZ9x 24VT120S 1616L30
Voltage	DC24V
Power	6W/M 1.82W/ft
CRI	90 (2835LEDs)
Led Qty	120LEDs/M 36LEDs/ft
Cutting Length	50mm 1.97"
IP Grade	IP67
Length/Reel	30m 98.42ft
Color temperature	● 2700K ● 3000K ● 4000K ○ 6000K
Lumens	300lm/m 91lm/ft 330lm/m 101lm/ft 360lm/m 110lm/ft 360lm/m 110lm/ft

End cap

Ordinary End Cap

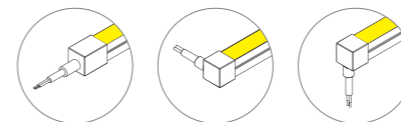

Mold end cap

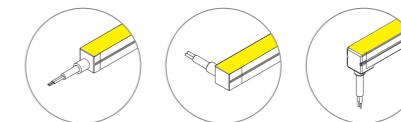

Injection-moulded endcap

*Cable can be bended to any direction.

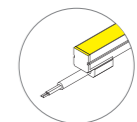

Dimension

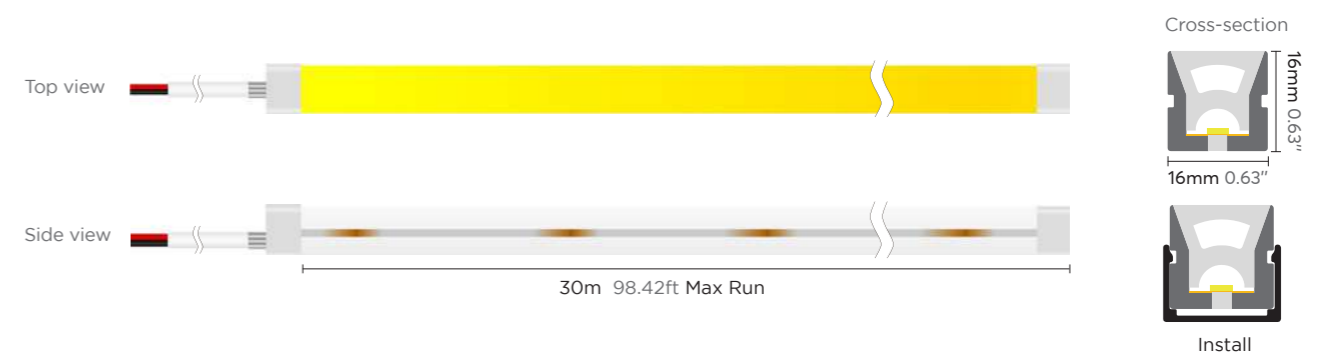

* Please contact our sales for the latest details and certifications

Long-Run NEON



Top bending

Up to 15m

16x16mm

Digital colorful SPI RGBW

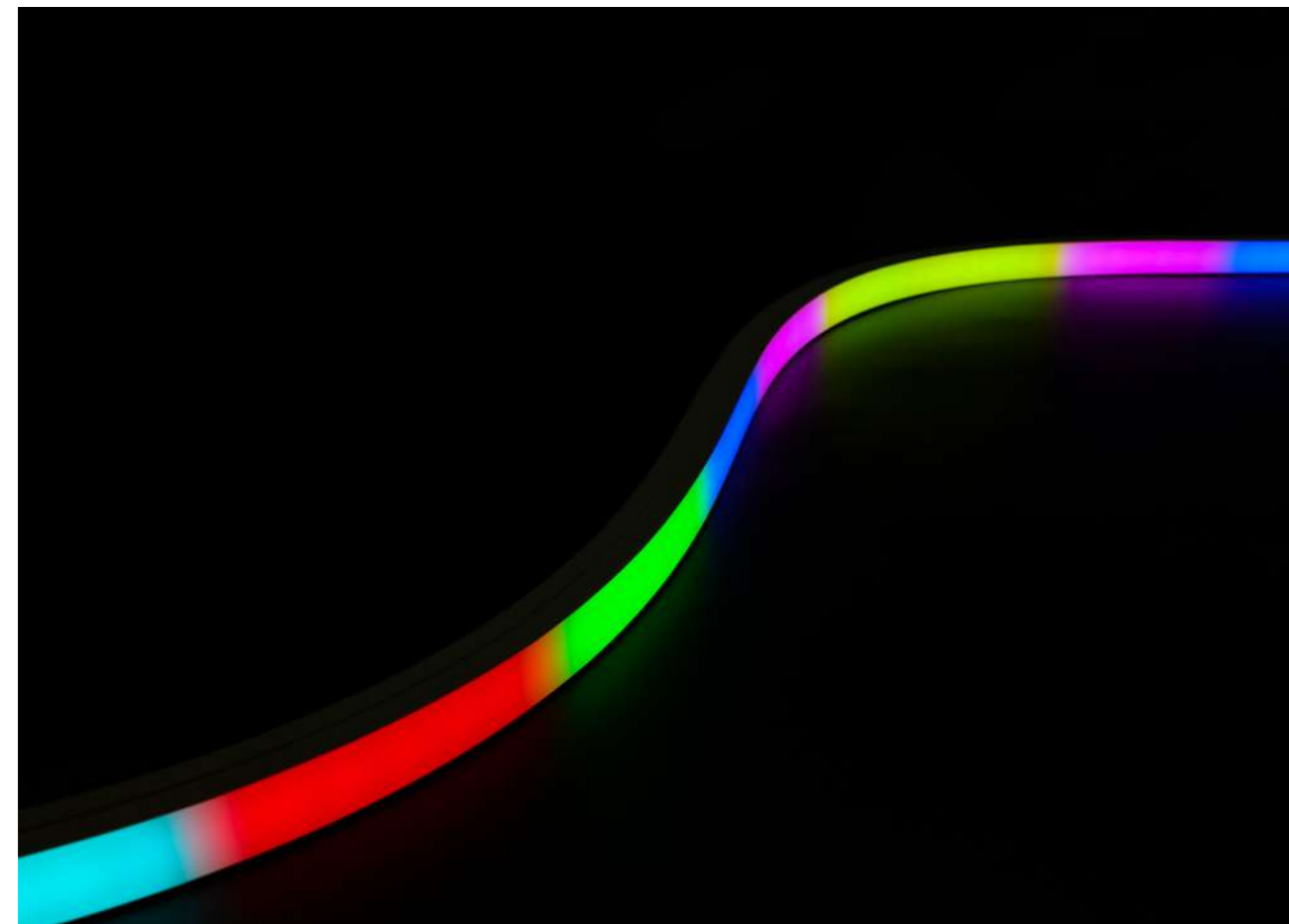

Seamless and uniform light output, dot free.
 Bendable at horizontal direction. IP67 protection.
 Robust housing with high quality silicon, UV proof for true outdoor application.
 Built-in IC/SM16703P, SPI signal protocol, single color, gradient color change, chasing, anima on and scene display.

Correct bending way

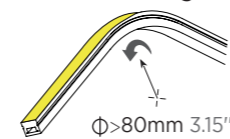

Technical Details **16x16mm 10m SPI RGBW 12W** **16x16mm 15m SPI RGBW 6W**

Product NO.	FEN12D-P7-G2 50ZRGB8x 24VS80S 1616L10	FEN06D-P7-G2 50ZRGB8x 24VS80S 1616L15
Voltage	DC24V	DC24V
Power	12W/M 3.66W/ft	6W/M 1.83W/ft
CRI	80 (5050LEDs)	80 (5050LEDs)
Led Qty	80LEDs/M 24LEDs/ft	80LEDs/M 24LEDs/ft
Cutting Length	100mm 3.94"	100mm 3.94"
IP Grade	IP67	IP67
Length/Reel	10m 32.8ft	15m 49.21ft
Color temperature	● R ● G ● B ● 3000K	● R ● G ● B ● 3000K
Lumens	31lm/m 9lm/ft 107lm/m 33lm/ft 25lm/m 8lm/ft 342lm/m 104lm/ft	31lm/m 9lm/ft 107lm/m 33lm/ft 25lm/m 8lm/ft 170lm/m 52lm/ft

End cap

Ordinary End Cap

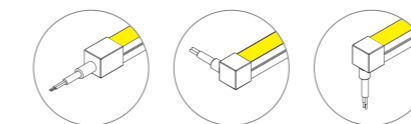

Mold end cap

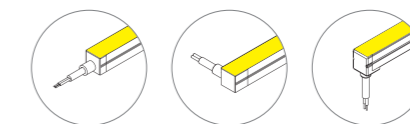

Injection-moulded endcap
 *Cable can be bended to any direction.

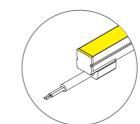

Dimension



* Please contact our sales for the latest details and certifications

Accessories



360° Lighting



360°
Lighting



IP65



More
applications



White
RGB/SPI

BEAM NEON

360° Lighting

Φ18mm White / 11W

Φ23mm White / 14W

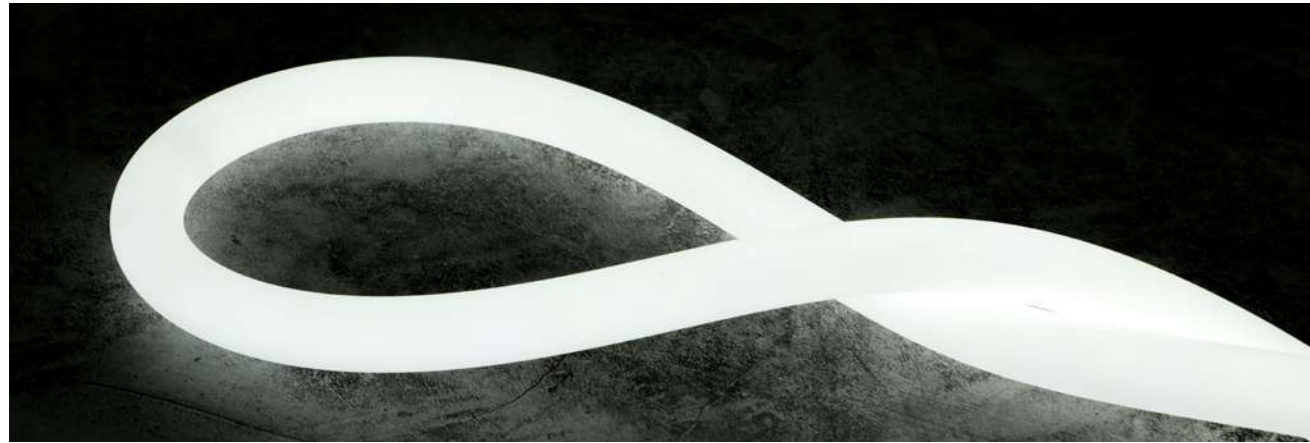

Matte oil material used on the surface, with excellent wear resistance, no dust, Soft and smooth feel of hand touch.

360° lighting, surface illuminate uniformly without any dark area.

It can be bent freely, with superior flexibility & wide application.

IP65, environmental-friendly silicone material, salt and alkali resistant, UV resistant, flame retardant.



Accessories



* Please contact us for more product accessories.

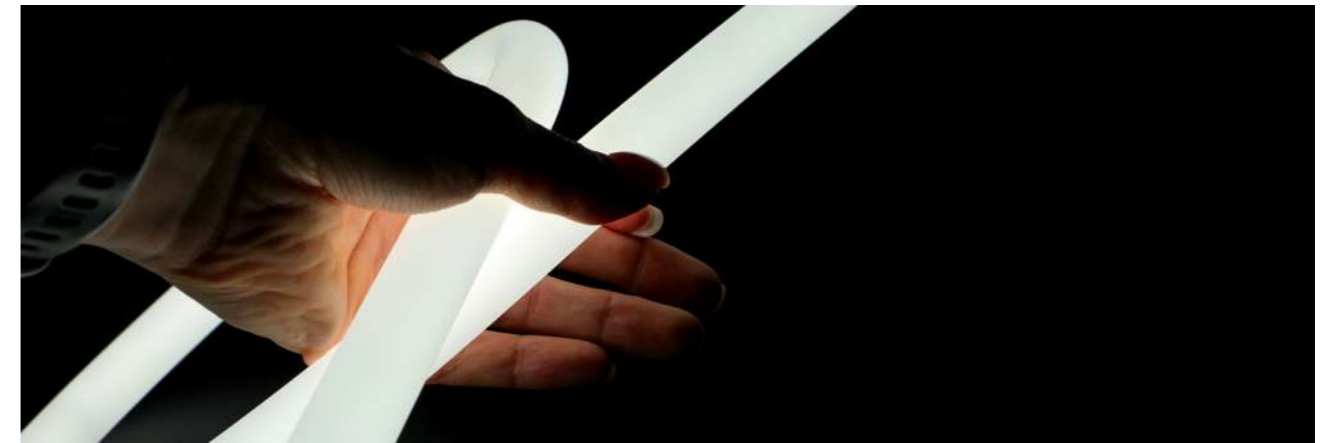

2700K 3000K 4000K 6000K

Technical Details

Φ18mm 11W White

Φ23mm 14W White

Product NO.	FEN11WR-P5-G1 -28AH9x 24V360D R18L05	FEN14WR-P5-G1 28AH9x 24V280D R23L05
Voltage	DC24V	DC24V
Power	11W/M 3.35W/ft	14W/M 4.27W/ft
CRI	90 (2835LEDs)	90 (2835LEDs)
Led Qty	360LEDs/M 109LEDs/ft	280LEDs/M 85LEDs/ft
Cutting Length	Arbitrarily Cutting	Arbitrarily Cutting
IP Grade	IP65	IP65
Diameter	18mm 0.7"	23mm 0.9"
Color temperature	● 2700K ● 3000K ● 4000K ○ 6000K	● 2700K ● 3000K ● 4000K ○ 6000K
Lumens	740lm/m 225lm/ft 770lm/m 234lm/ft 780lm/m 237lm/ft 780lm/m 237lm/ft	950lm/m 290lm/ft 990lm/m 302lm/ft 1000lm/m 305lm/ft 1000lm/m 305lm/ft

Note: 'x' (CCT) = *27*(2700K) / *30*(3000K) / *40*(4000K) / *50*(5000K) / *60*(6000K), Please contact us for more information.

Dimension

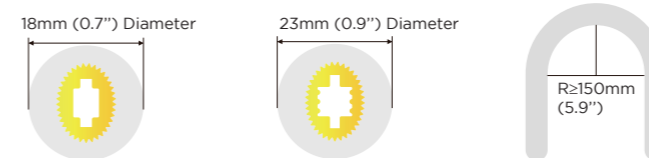

* Please contact our sales for the latest details and certifications

BEAM NEON

360° Lighting

Φ23mm / RGB

Φ23mm / SPI



Matte oil material used on the surface, with excellent wear resistance, no dust, Soft and smooth feel of hand touch.

360° lighting, surface illuminate uniformly without any dark area.

It can be bent freely, with superior flexibility & wide application.

IP65, environmental-friendly silicone material, salt and alkali resistant, UV resistant, flame retardant.



Accessories

Clips



Feeder cap



R23

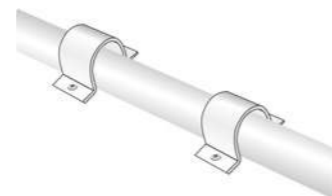

* Please contact us for more product accessories.



Technical Details	Φ23mm 18W RGB	Φ23mm 16W RGB SPI				
Product NO.	FEN18CR-P5-G1 38ZRGB 24V240D R23L05	FEN16DR-P5-G1 50ZRGB 24VS168D R23L05				
Voltage	DC24V	DC24V				
Power	18W/M 5.49W/ft	16W/M 4.89W/ft				
CRI	/ (3838LEDs)	/ (5050LEDs)				
Led Qty	240LEDs/M 73LEDs/ft	168LEDs/M 51LEDs/ft				
Cutting Length	50mm 1.97"	71.4mm 2.81"				
IP Grade	IP65	IP65				
Diameter	23mm 0.9"	23mm 0.9"				
Color temperature	●R ●G ●B	●R ●G ●B				
Lumens	140lm/m 43lm/ft	370lm/m 113lm/ft	75lm/m 23lm/ft	133lm/m 41lm/ft	350lm/m 107lm/ft	60lm/m 18lm/ft

Note: 'x' (CCT) = *27*(2700K) / *30*(3000K) / *40*(4000K) / *50*(5000K) / *60*(6000K), Please contact us for more information.

Dimension

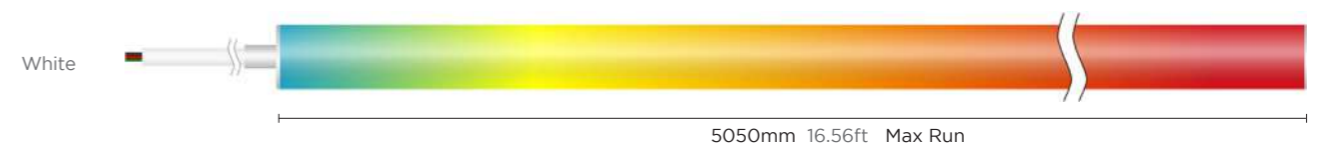

23mm (0.9") Diameter

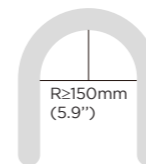
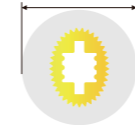

* Please contact our sales for the latest details and certifications

BEAM NEON

360° Lighting

Φ25mm White/ RGBW



Matte oil material used on the surface, with excellent wear resistance, no dust, Soft and smooth feel of hand touch.

360° lighting, surface illuminate uniformly without any dark area.

It can be bent freely, with superior flexibility & wide application.

IP65, environmental-friendly silicone material, salt and alkali resistant, UV resistant, flame retardant.



Accessories

Clips



Feeder cap



R25

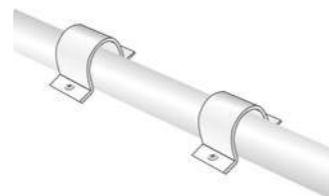

* Please contact us for more product accessories.



2700K 3000K 4000K 6000K



Technical Details

Φ25mm 14W White

Φ25mm 18W RGBW

Product NO.	FEN14WR-P5-G1 28AH9x 24V280D R25L05	FEN18CR-P5-G1 50ZRGB8x 24V192D R25L05
Voltage	DC24V	DC24V
Power	14W/M 4.27W/ft	18W/M 5.49W/ft
CRI	90 (2835LEDs)	/ (5050LEDs)
Led Qty	280LEDs/M 85LEDs/ft	192LEDs/M 58LEDs/ft
Cutting Length	Arbitrarily Cutting (50mm Soldering Pad Distance)	62mm 1.94"
IP Grade	IP65	IP65
Diameter	25mm 0.98"	25mm 0.98"
Color temperature	● 2700K ● 3000K ● 4000K ○ 6000K	● R ● G ● B ● 4000K
Lumens	855lm/m 261lm/ft 900lm/m 274lm/ft 925lm/m 282lm/ft 925lm/m 282lm/ft	90lm/m 27lm/ft 300lm/m 91lm/ft 65lm/m 20lm/ft 260lm/m 79lm/ft

Note: 'x' (CCT) = "27"(2700K) / "30"(3000K) / "40"(4000K) / "50"(5000K) / "60"(6000K), Please contact us for more information.

Dimension

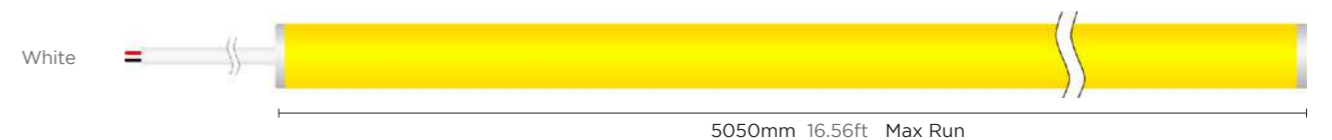

25mm (0.98") Diameter

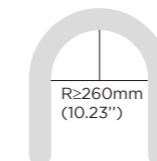
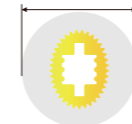

* Please contact our sales for the latest details and certifications

BEAM NEON

Shapeable bendable 360° Lighting

Φ22mm White / 14W



Cuttable, bendable, shapeable. flexible, free DIY. With superior flexibility & wide application.

360° lighting, surface illuminate uniformly without any dark area.

Matte oil material used on the surface, with excellent wear resistance, no dust, Soft and smooth feel of hand touch.

IP65, environmental-friendly silicone material, salt and alkali resistant, UV resistant, flame retardant.



Accessories

Clips



Feeder cap



* Please contact us for more product accessories.



2700K 3000K 4000K 6000K

Technical Details Φ22mm 14W White

Product NO.	FEN14WR-P5-G1 28HZ9x 24V280D R22L02			
Voltage	DC24V			
Power	14W/M 4.27W/ft			
CRI	90 (2835LEDs)			
Led Qty	280LEDs/M 85LEDs/ft			
Cutting Length	Arbitrarily Cutting			
IP Grade	IP65			
Diameter	22mm 0.86"			
Color temperature	● 2700K	● 3000K	● 4000K	○ 6000K
Lumens	855lm/m 260lm/ft	900lm/m 274lm/ft	925lm/m 282lm/ft	925lm/m 282lm/ft

Note: 'x' (CCT) = *27*(2700K) / *30*(3000K) / *40*(4000K) / *50*(5000K) / *60*(6000K), Please contact us for more information.

Dimension

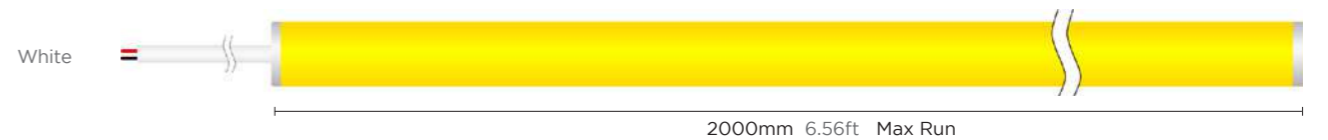

22mm (0.86") Diameter

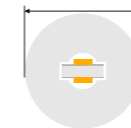

R≥500mm
(19.68")

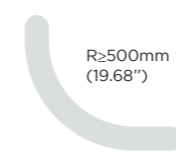

*Bending radius ≥ 500mm, the number of bends in the same position ≤ 7 times.

* Please contact our sales for the latest details and certifications

BEAM NEON

360° Lighting Weaving pattern on the surface

Φ22mm White / 14W

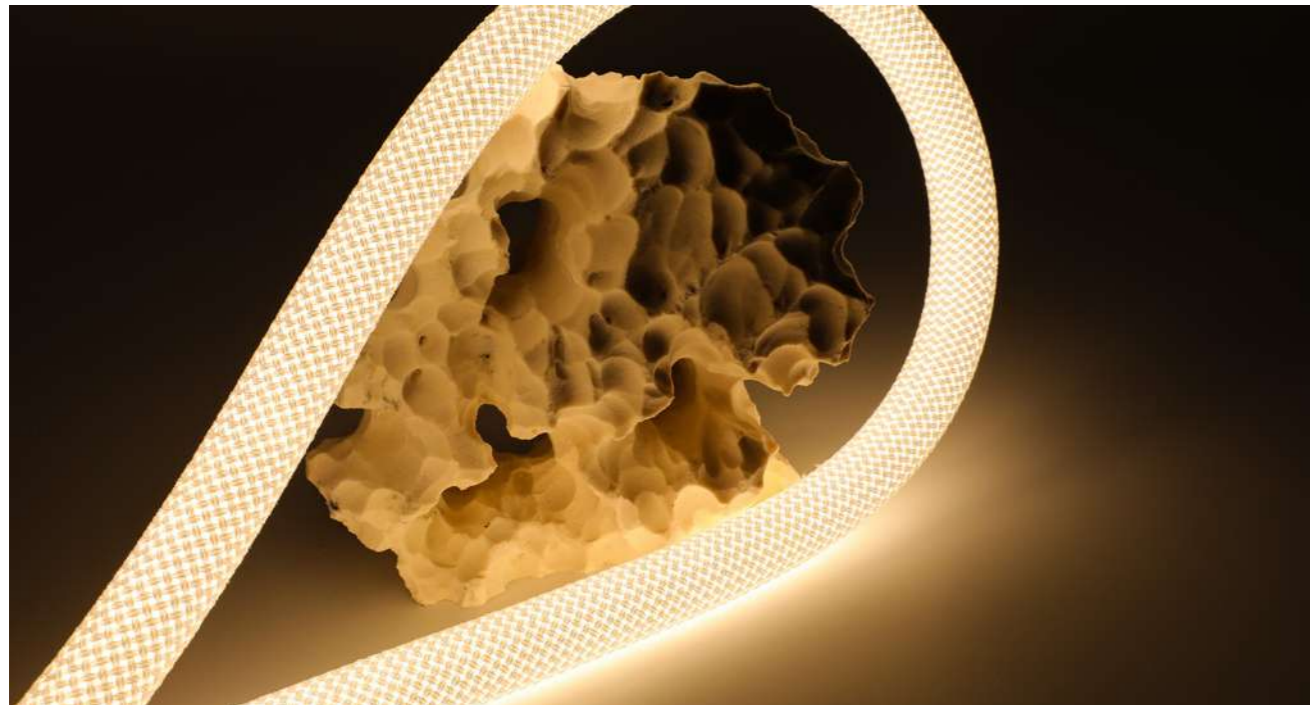

Weaving pattern on the surface 360° lighting, surface illuminate uniformly without any dark area.
It can be bent freely, with superior flexibility & wide application.
IP65, environmental-friendly silicone material, salt and alkali resistant, UV resistant, flame retardant.



Accessories

Clips



Feeder cap



* Please contact us for more product accessories.



2700K 3000K 4000K 6000K

Technical Details Φ22mm 14W White

Product NO.	FEN14WR-P5-G1 28AH9x 24V280D R22L03			
Voltage	DC24V			
Power	14W/M 4.27W/ft			
CRI	90 (2835LEDs)			
Led Qty	280LEDs/M 85LEDs/ft			
Cutting Length	Arbitrarily Cutting			
IP Grade	IP65			
Diameter	22mm 0.86"			
Color temperature	● 2700K	● 3000K	● 4000K	○ 6000K
Lumens	745lm/m 227lm/ft	785lm/m 239lm/ft	815lm/m 248lm/ft	815lm/m 248lm/ft

Note:'x' (CCT) = *27*(2700K) / *30*(3000K) / *40*(4000K) / *50*(5000K) / *60*(6000K), Please contact us for more information.

Dimension

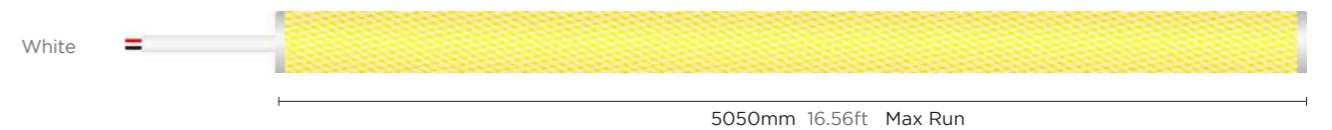

22mm (0.86") Diameter



* Please contact our sales for the latest details and certifications



3D Bending NEON

8x8mm

Top&side bending integrated

Mini size, 8x8mm, More free bending and Twist-able
 High efficacy 2216 Plus LED inside.
 UV and yellowish resistant, IP67 and salt-mist proof.
 Easy installation.



NEON SERIES · 3D BENDING

NEON SERIES · 3D BENDING

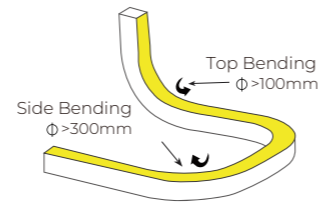

Accessories



Technical Details 8X8mm Free cut

8X8mm Mini cut

Product NO.	FEN06WTS-P7-G1 22X9x 24V238S1 0808L05	FEN06WTS-P7-G1 22X9x 24V238S7 0808L05
Voltage	DC24V	DC24V
Power	6W/M 1.83W/ft	6W/M 1.83W/ft
CRI	90(2216LEDs)	90(2216LEDs)
Led Qty	238LEDs/M 73LEDs/ft	238LEDs/M 73LEDs/ft
Cutting Length	29.4mm 1.16" Soldering Pad Distance	29.4mm 1.16"
IP Grade	IP67	IP67
Length/Reel	5M 16.56ft	5M 16.56ft
Color temperature	● 2700K ● 3000K ● 4000K ○ 6000K	● 2700K ● 3000K ● 4000K ○ 6000K
Lumens	288lm/m 88lm/ft 300lm/m 92lm/ft 312lm/m 95lm/ft 312lm/m 95lm/ft	360lm/m 110lm/ft 380lm/m 116lm/ft 390lm/m 119lm/ft 390lm/m 119lm/ft

End cap

Ordinary End Cap

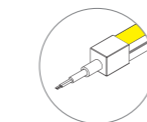

Dimension

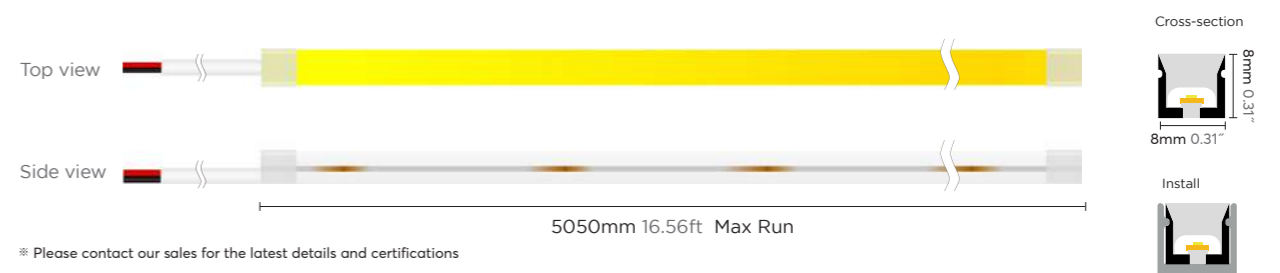

* Please contact our sales for the latest details and certifications



3D Bending NEON

16x18mm

Top&side bending integrated

Free bending and Twist-able, High efficacy 2835 LED inside.
Dual-color silicone extrusion,UV and yellowish resistant.
IP67 and salt-mist proof.
Easy installation.

Top Bending

Side Bending

NEON SERIES · 3D BENDING

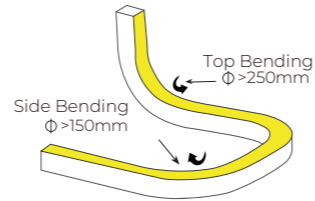

Accessories

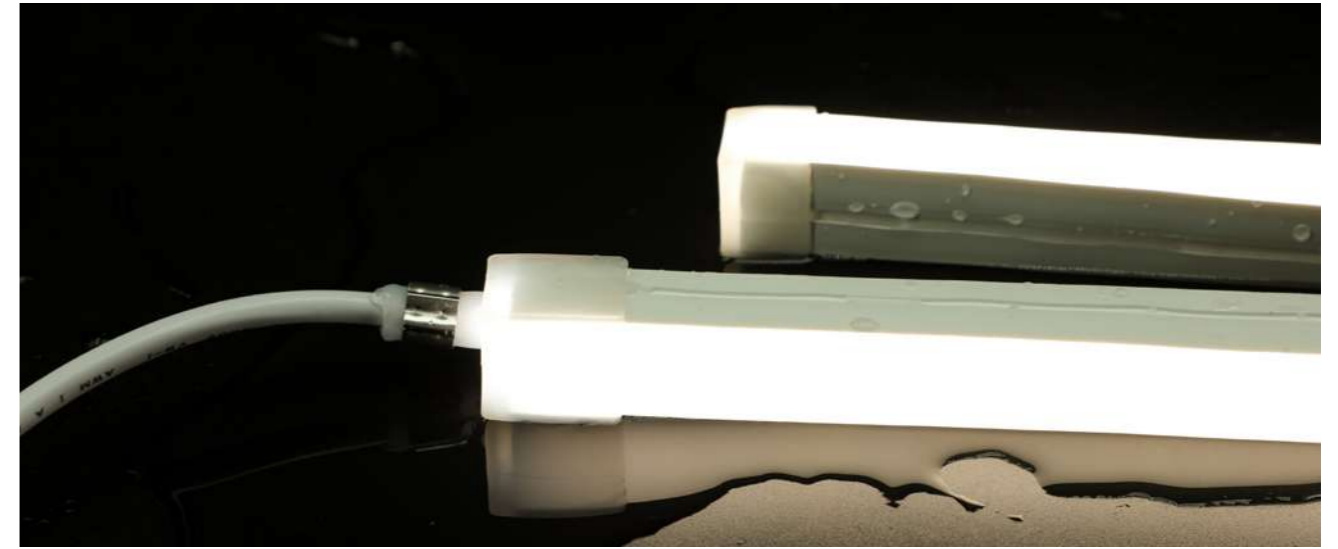

2700K 3000K 4000K 6000K

Technical Details 16X18mm

Product NO.	FEN14WTS-P7-G1 28AH9x 24V120S3 1618L05			
Voltage	DC24V			
Power	14W/M 4.27W/ft			
CRI	90 (2835LEDs)			
Led Qty	120LEDs/M 36LEDs/ft			
Cutting Length	25mm 0.98"			
IP Grade	IP67			
Length/Reel	5M 16.56ft			
Color temperature	● 2700K	● 3000K	● 4000K	○ 6000K
Lumens	700lm/m 213lm/ft	740lm/m 225lm/ft	760lm/m 232lm/ft	760lm/m 232lm/ft

End cap

Ordinary End Cap

Mold end cap

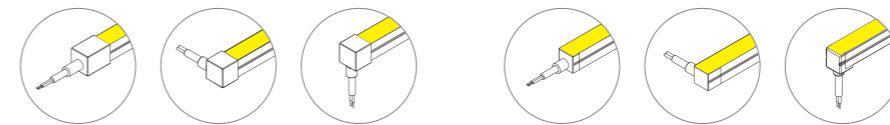

Dimension



* Please contact our sales for the latest details and certifications

NEON SERIES · 3D BENDING

IP68 NEON



IP68



IK08



More safer

The product has a water-repellent rating of IP68.
Equipped with a 2835 / 5050 LED light source
that is both bright and energy-efficient.

IP68 NEON

16x16mm White

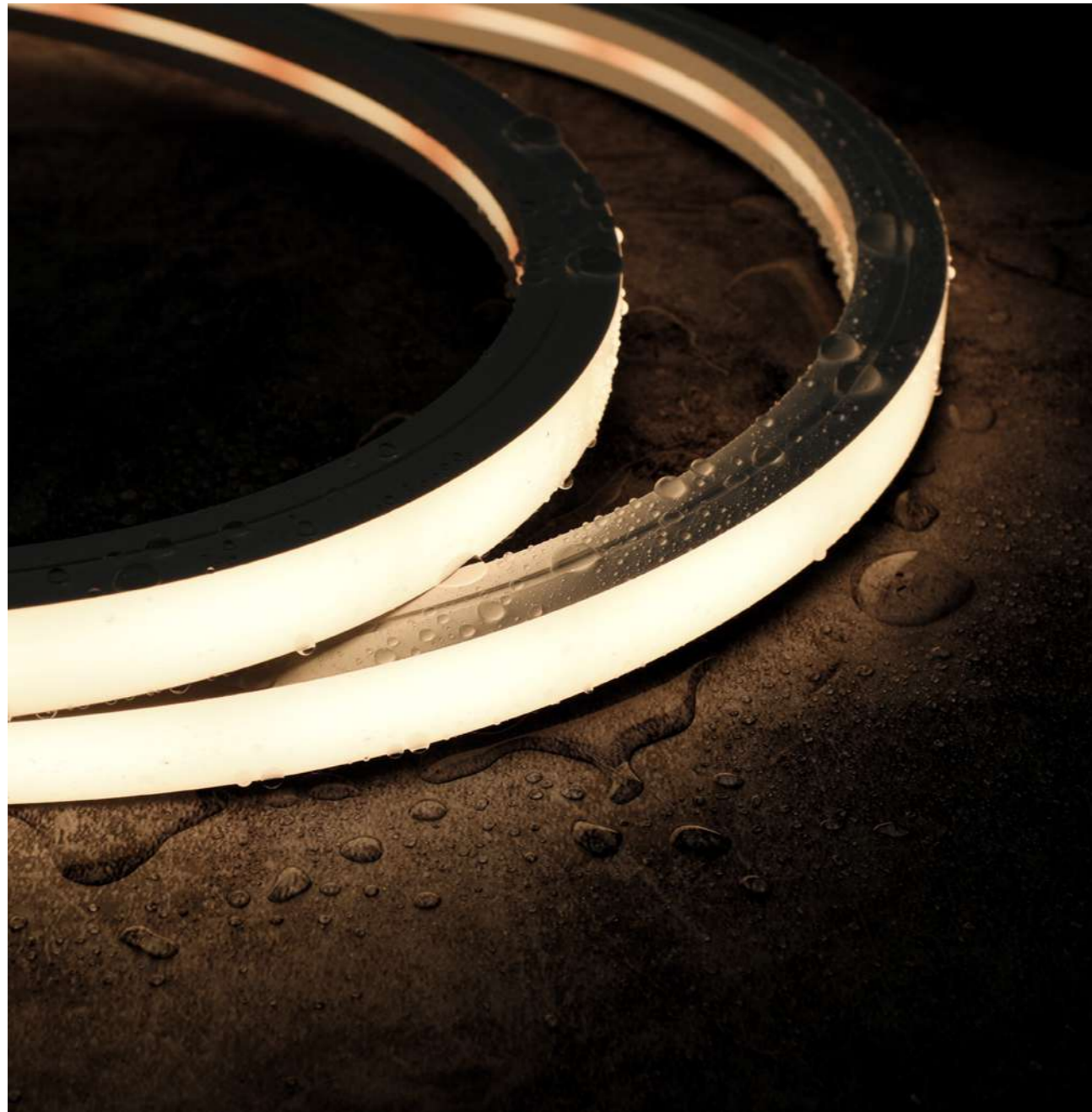
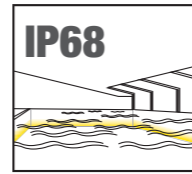

NEON SERIES · IP68 NEON

Accessories



Correct bending way

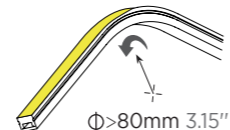

2700K 3000K 4000K 6000K



IP68 16x16mm / Top Bending

Technical Details

Product NO.	FEN14W-P8-G2 28HZ9x 24V120S 1616L05		
Voltage	DC24V		
Power	14W/M 4.39W/ft		
CRI	90 (2835LEDs)		
Led Qty	120LEDs/M 37LEDs/ft		
Cutting Length	50mm 1.97"		
IP Grade	IP68		
Length/Reel	5m 16.56ft		
Color temperature	<input checked="" type="radio"/> 2700K	<input type="radio"/> 3000K	<input type="radio"/> 4000K <input type="radio"/> 6000K
Lumens	600lm/m 183lm/ft	645lm/m 197lm/ft	685lm/m 209lm/ft 685lm/m 209lm/ft

End cap

Ordinary End Cap

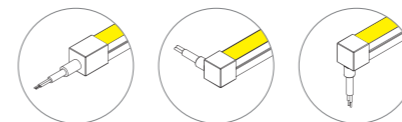

Dimension



* Please contact our sales for the latest details and certifications

NEON SERIES · IP68 NEON

IP68 NEON

20x18mm DMX RGBW

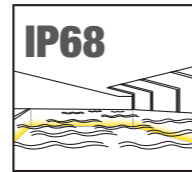

NEON SERIES · IP68 NEON

NEON SERIES · IP68 NEON

Accessories



Correct bending way

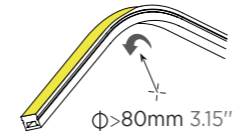

IP68 20x18mm / Top Bending

Technical Details

Product NO.	FEN16D-P8-G2 50ZRGB9x 24VD70S7 2018L05			
Voltage	DC24V			
Power	16W/M 4.87W/ft			
CRI	90 (5050LEDs)			
Led Qty	70LEDs/M 21LEDs/ft			
Cutting Length	100mm 3.94"			
IP Grade	IP68			
Length/Reel	5m 16.56ft			
Color temperature	● R	● G	● B	● 4000K
Lumens	65lm/m 19lm/ft	177lm/m 44m/ft	37lm/m 11lm/ft	170lm/m 52lm/ft

End cap

Ordinary End Cap

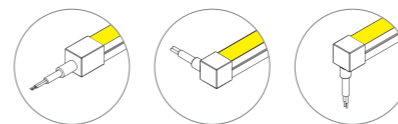

Dimension

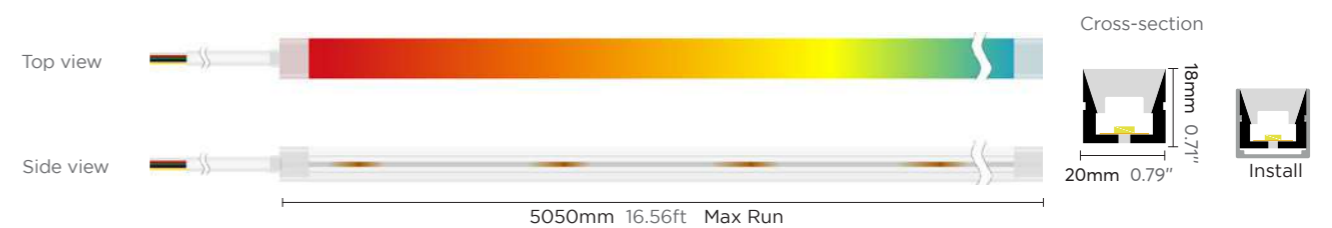

※ Please contact our sales for the latest details and certifications

IP68 NEON

10x18mm White

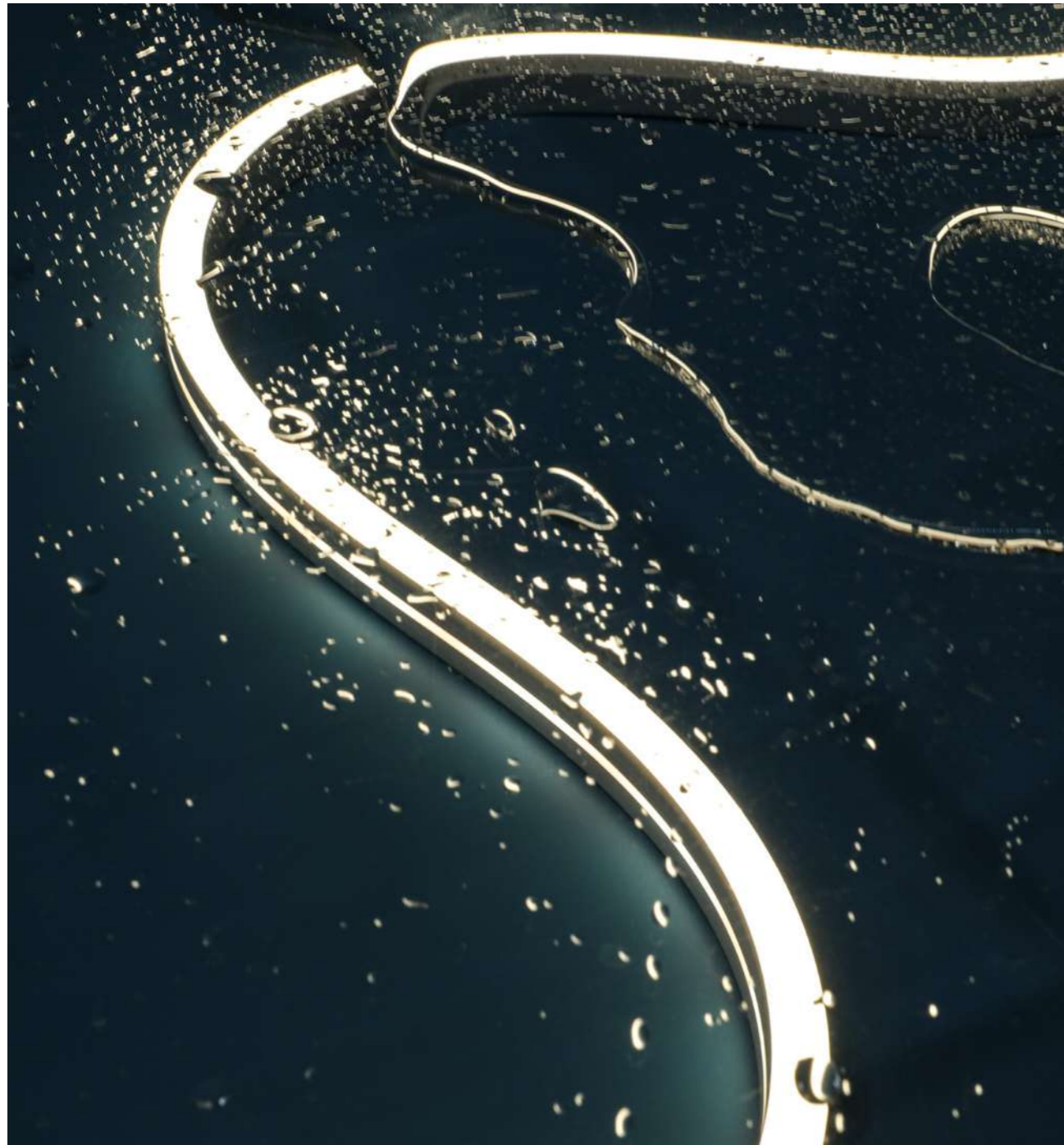
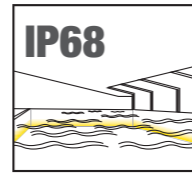

NEON SERIES · IP68 NEON

Accessories



Correct bending way

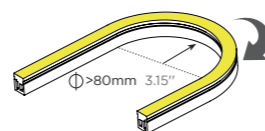

2700K 3000K 4000K 6000K



IP68 10x18mm / Side Bending

Technical Details

Product NO.	FEN14WS-P8-G2 28HZ9x 24V120S 1018L05		
Voltage	DC24V		
Power	14W/M 4.39W/ft		
CRI	90 (2835LEDs)		
Led Qty	120LEDs/M 37LEDs/ft		
Cutting Length	50mm 1.97"		
IP Grade	IP68		
Length/Reel	5m 16.56ft		
Color temperature	<input checked="" type="radio"/> 2700K	<input checked="" type="radio"/> 3000K	<input checked="" type="radio"/> 4000K <input type="radio"/> 6000K
Lumens	520lm/m 159lm/ft	578lm/m 176lm/ft	590lm/m 180lm/ft 605lm/m 184lm/ft

End cap

Ordinary End Cap

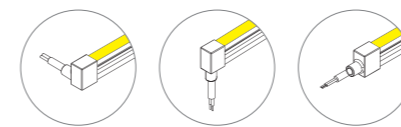

Dimension

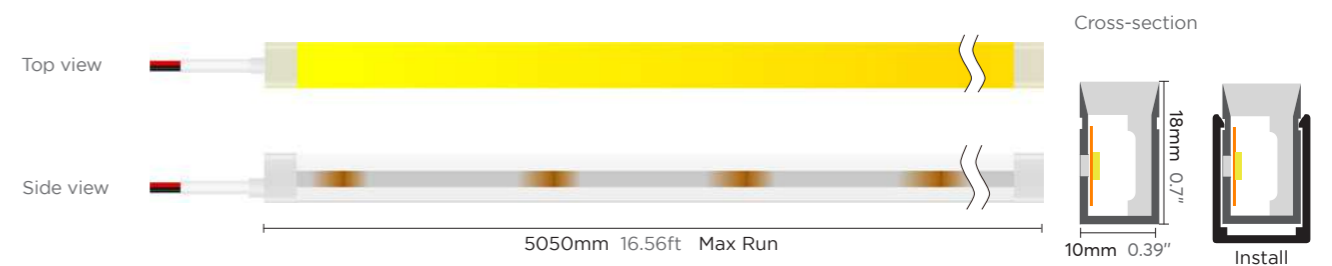

※ Please contact our sales for the latest details and certifications

NEON SERIES · IP68 NEON

IP68 NEON

12x20mm DMX RGBW

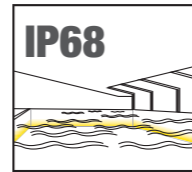

NEON SERIES · IP68 NEON

NEON SERIES · IP68 NEON

Accessories



Correct bending way

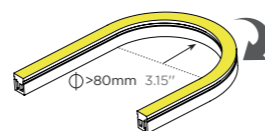

IP68 12x20mm / Side Bending

Technical Details

Product NO.	FEN14DS-P8-G2 50ZRGB9X 24VD70S7 1220L05			
Voltage	DC24V			
Power	14W/M 4.39W/ft			
CRI	90 (5050LEDs)			
Led Qty	70LEDs/M 21LEDs/ft			
Cutting Length	100mm 3.94"			
IP Grade	IP68			
Length/Reel	5m 16.56ft			
Color temperature	● R	● G	● B	● 4000K
Lumens	45lm/m 14lm/ft	138lm/m 42m/ft	26lm/m 8lm/ft	113lm/m 34lm/ft

End cap

Ordinary End Cap

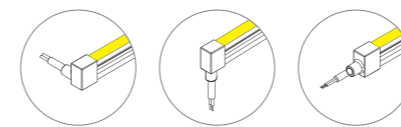

Dimension

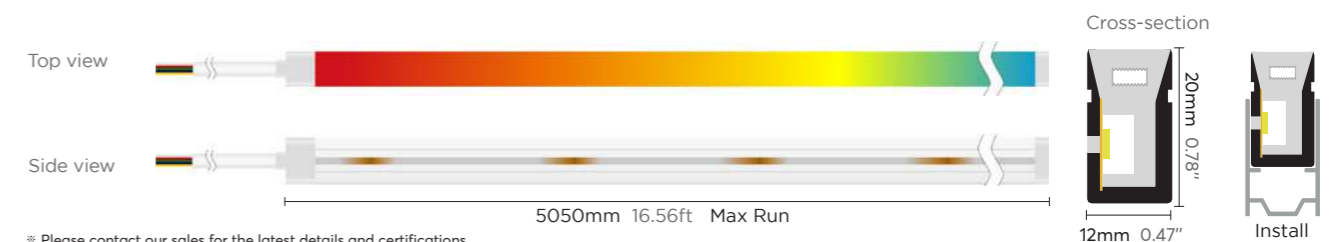

※ Please contact our sales for the latest details and certifications

Digital Colorful NEON



Digital Colorful

 Top bending

16x16mm RGBW DMX Controlled

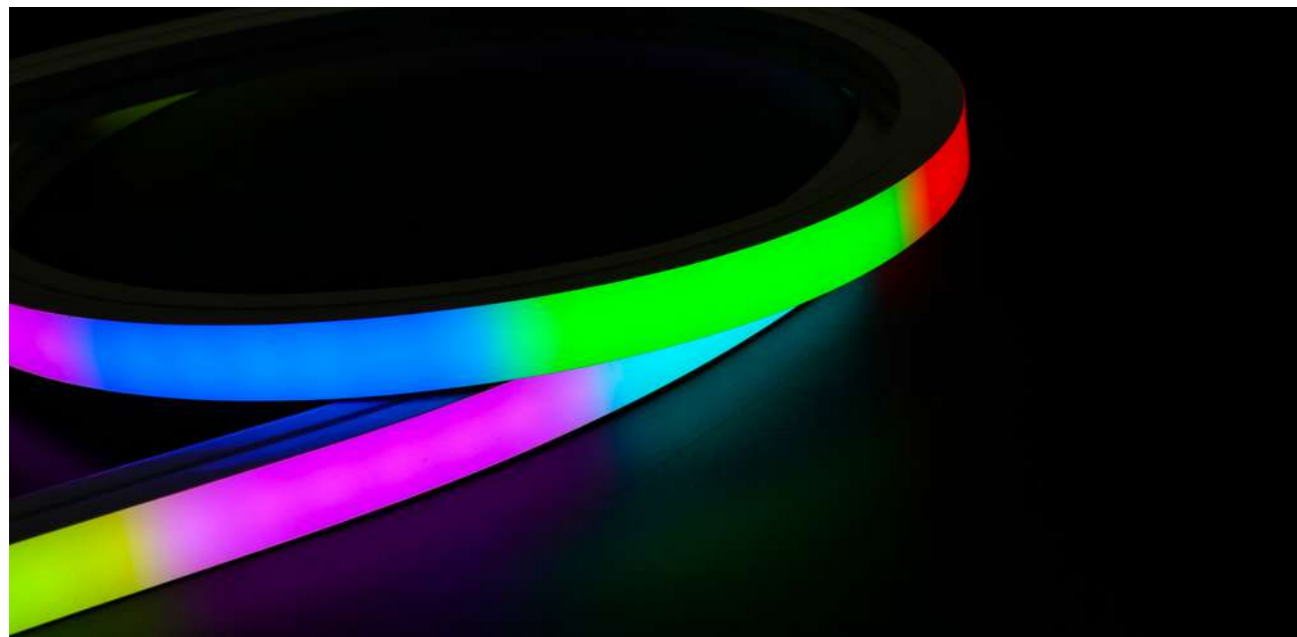

Built-in IC/SM18522PS, DMX512 signal protocol, single color, gradient color change, chasing, anima on and scene display.

Correct bending way

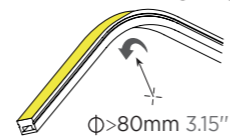

Accessories



Technical Details **16x16mm RGBW 14W**

Product NO.	FEN14D-P7-G1 50ZRGB8X 24VD80S10 1616L05			
Voltage	DC24V			
Power	14W/M 4.26W/ft			
CRI	80 (5050LEDs)			
Led Qty	80LEDs/M 24LEDs/ft			
Cutting Length	125mm 4.92''			
IP Grade	IP67			
Length/Reel	5050mm 16.56ft			
Color temperature	● R	● G	● B	● 3000K
Lumens	40lm/m 5lm/ft	128lm/m 39lm/ft	51lm/m 15lm/ft	130lm/m 40lm/ft

End cap

Ordinary End Cap

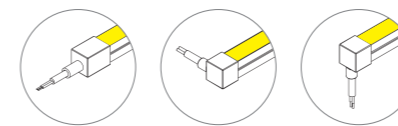

Mold end cap

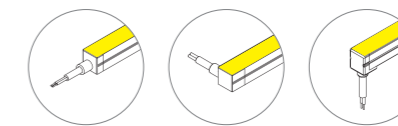

Injection-moulded endcap

*Cable can be bended to any direction.

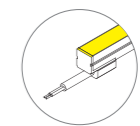

Dimension

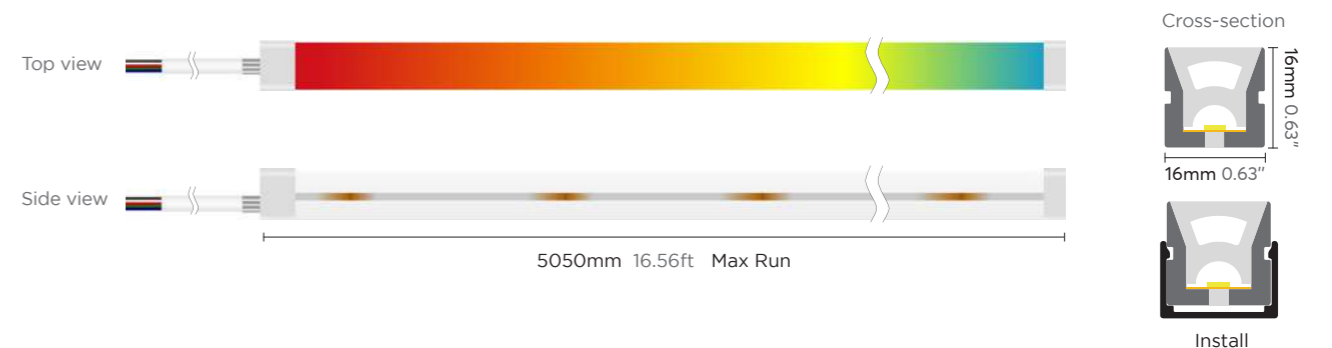

* Please contact our sales for the latest details and certifications

Digital Colorful NEON

 Top bending

16x20mm RGBW DMX Controlled

16mm light-emitting surface, uniform light, dot free.
RGBW Top emitting, meet a variety of side bending light shape.
Extrusion process, IP67, achieve temporary immersion.
With high quality silicon, UV proof for outdoor application.



Accessories



Correct bending way

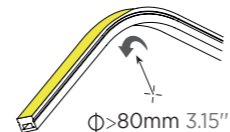

Technical Details **16x20mm DMX Controlled RGBW 15W**

Product NO.	FEN15D-P7-G1 50ZRGB9x 24VD70S7 1620L05			
Voltage	DC24V			
Power	15W/M 4.57W/ft			
CRI	90 (5050LEDs)			
Led Qty	70LEDs/M 21LEDs/ft			
Cutting Length	100mm 3.94"			
IP Grade	IP67			
Length/Reel	5050mm 16.56ft			
Color temperature	● R	● G	● B	● 3000K
Lumens	50lm/m 15lm/ft	130lm/m 40lm/ft	36lm/m 11lm/ft	175lm/m 53lm/ft

End cap

Ordinary End Cap

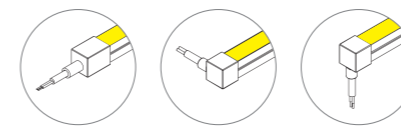

Dimension

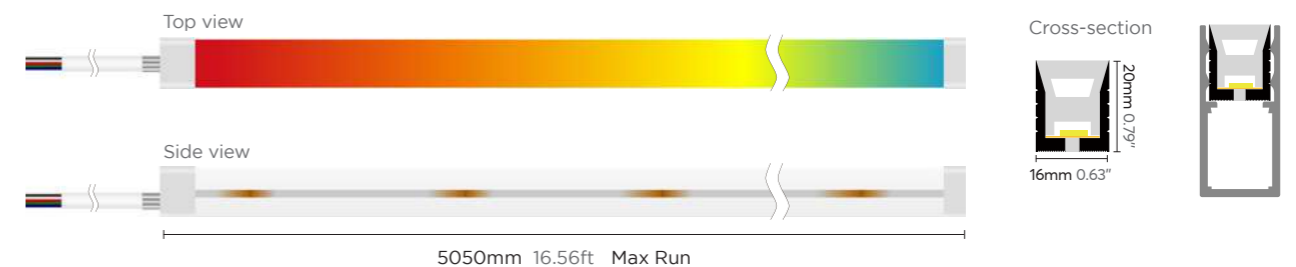

* Please contact our sales for the latest details and certifications

Digital Colorful NEON

 Top bending

25x25mm RGB/RGBW DMX Controlled

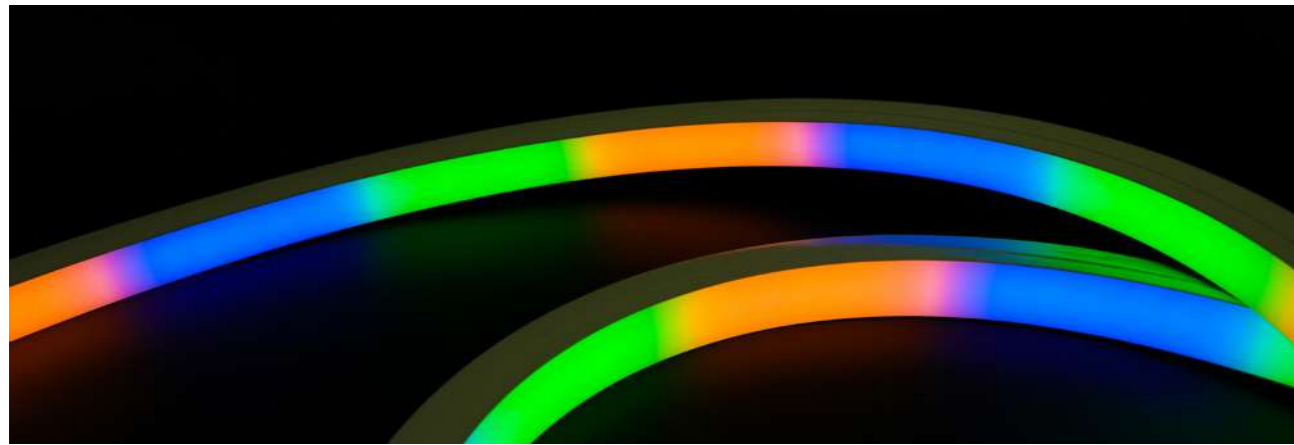

Seamless and uniform light output, dot free.
Built-in IC/SM18522PS, DMX512 signal protocol, single color, gradient color change, chasing, anima on and scene display.
Varying color programs can be controlled by 8 pixels per meter.

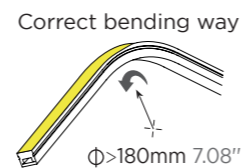

Accessories

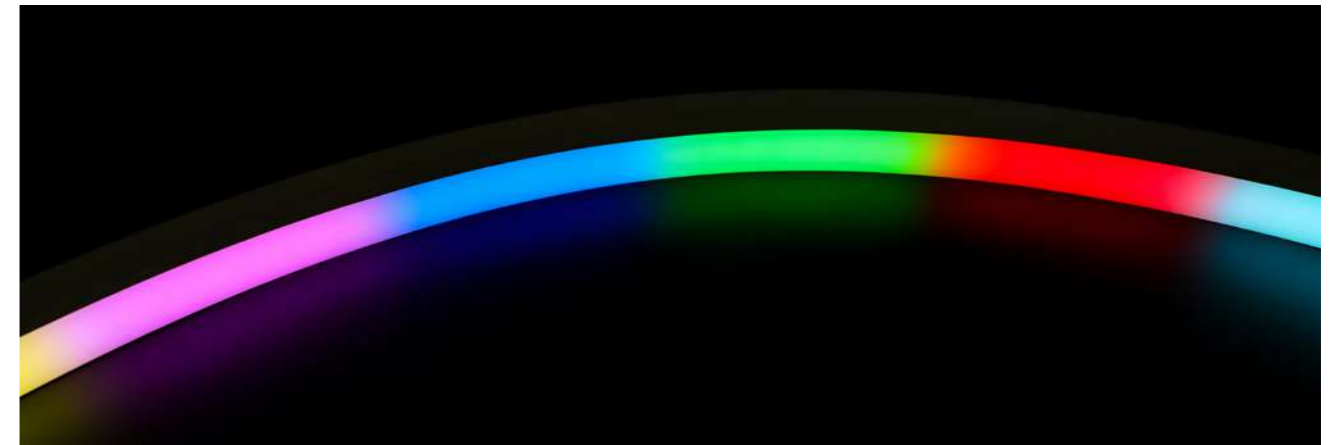

Technical Details	25x25mm RGB DMX 12W	25x25mm RGBW DMX 12W
Product NO.	FEN12D-P7-G1 50ZRGB 24VD56S7 2525L05	FEN12D-P7-G1 50ZRGB9X 24VD56S7 2525L05
Voltage	DC24V	DC24V
Power	12W/M 3.65W/ft	12W/M 3.65W/ft
CRI	/ (5050LEDs)	90 (5050LEDs)
Led Qty	56LEDs/M 17LEDs/ft	56LEDs/M 17LEDs/ft
Cutting Length	125mm 4.92"	125mm 4.92"
IP Grade	IP67	IP67
Length/Reel	5050mm 16.56ft	5050mm 16.56ft
Color temperature	● R ● G ● B	● R ● G ● B ● 3000K
Lumens	30lm/m 9lm/ft 72lm/m 21lm/ft 16lm/m 4lm/ft	30lm/m 9lm/ft 72lm/m 21lm/ft 16lm/m 4lm/ft 93m/m 28lm/ft

End cap

Ordinary End Cap

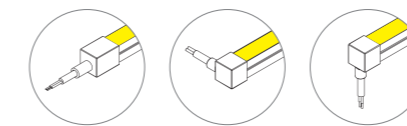

Injection-moulded endcap

*Cable can be bended to any direction.

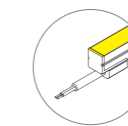

Dimension

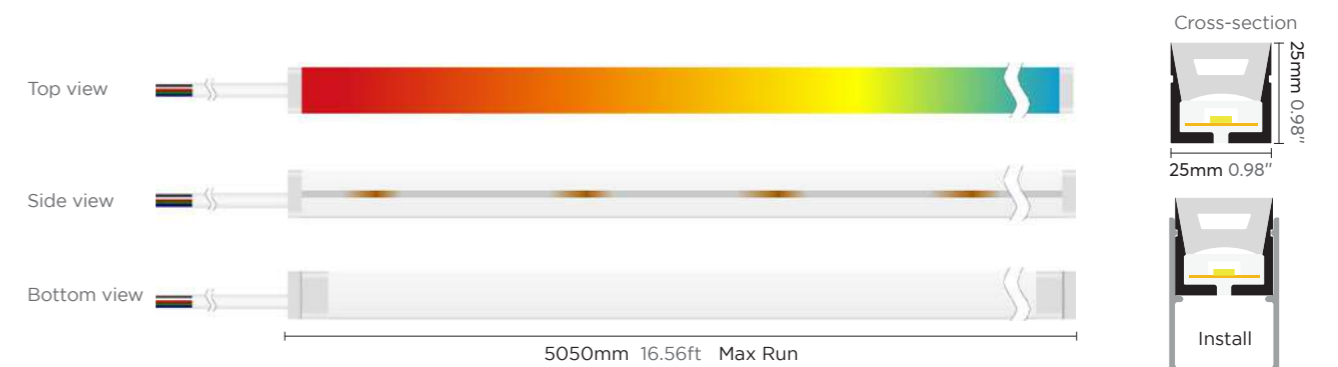

* Please contact our sales for the latest details and certifications

Digital Colorful NEON

 Top bending

30x17mm RGBW DMX Controlled



Seamless and uniform light output, dot free.
Built-in IC/UCS512H5L, DMX512 signal protocol, single color, gradient color change, chasing, anima on and scene display.
Varying color programs can be controlled by 12 pixels per meter.

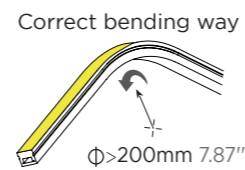

Accessories



Technical Details

30x17mm RGBW DMX 20W

Product NO.	FEN20D-P7-G2 50ZRGB9X 24VD168D14 3017L05			
Voltage	DC24V			
Power	20W/M 6.1W/ft			
CRI	90 (5050LEDs)			
Led Qty	168LEDs/M 51LEDs/ft			
Cutting Length	83.3mm 3.28"			
IP Grade	IP67			
Length/Reel	5050mm 16.56ft			
Color temperature	● R	● G	● B	● 3000K
Lumens	104lm/m 32lm/ft	383lm/m 116lm/ft	90lm/m 27lm/ft	450m/m 137lm/ft

End cap

Ordinary End Cap

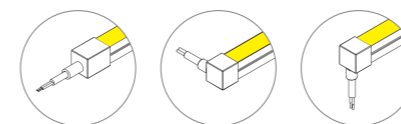

Dimension

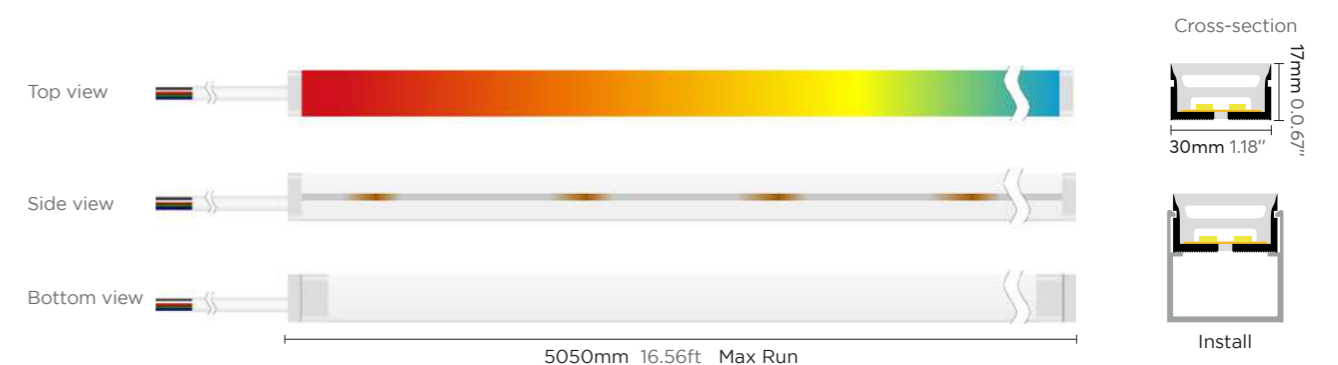

* Please contact our sales for the latest details and certifications

Digital Colorful NEON

 Side bending

10x18mm RGB DMX Controlled

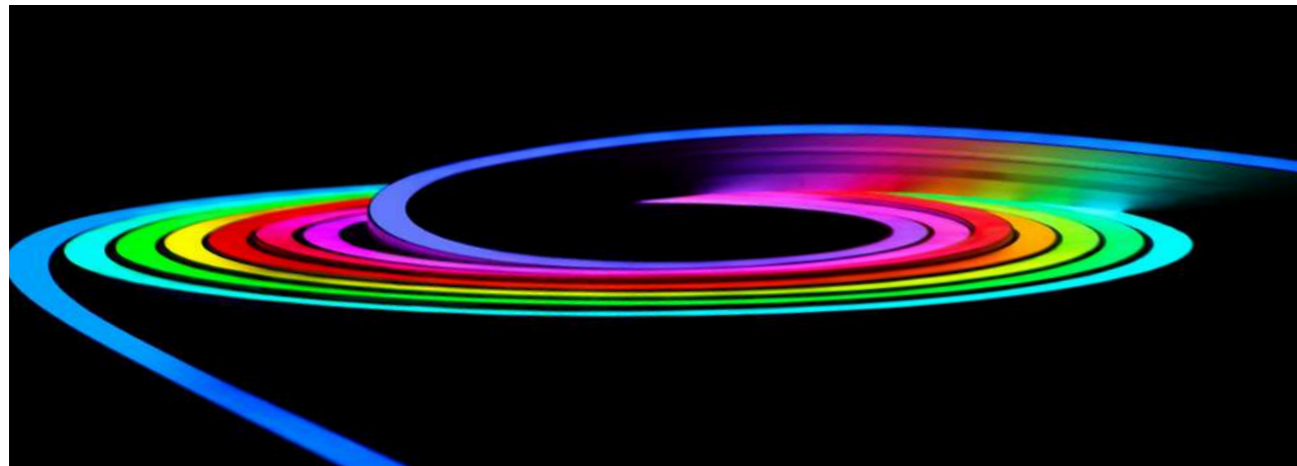

Seamless and uniform light output, dot free, Bendable at horizontal direction.
Built-in IC/SM18522PS, DMX512 signal protocol, single color, gradient color change, chasing, anima on and scene display.
Robust housing with high quality silicon, UV proof for true outdoor application.
Cut-able for flexible application, easy installation with clips and bendable track.



Correct bending way

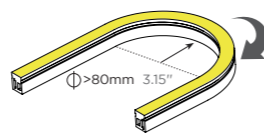

Accessories

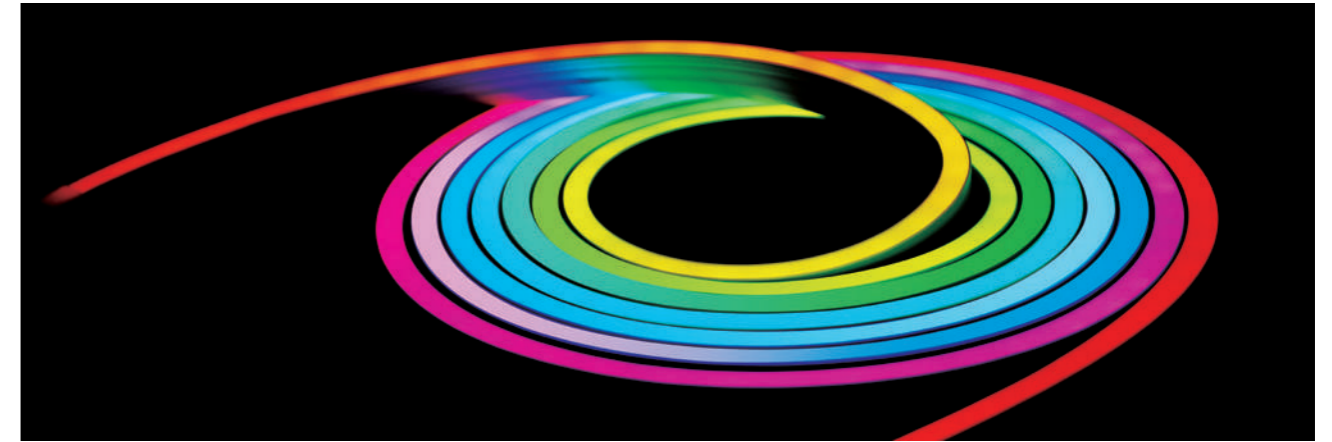

Technical Details **DMX 10x18mm 12W 56LEDs/M** **SPI 10x18mm 14W 60LEDs/M**

Product NO.	FEN12DS-P7-G1 50ZRGB 24VD56S 1018L05	FEN14DS-P7-G1 50AWRGB 24VD60S 1018L05
Voltage	DC24V	DC24V
Power	12W/M 3.28W/ft	14W/M 4.26W/ft
CRI	- (5050LEDs)	- (5050LEDs)
Led Qty	56LEDs/M 17LEDs/ft	60LEDs/M 18LEDs/ft
Cutting Length	125mm 4.92"	100mm 3.93"
IP Grade	IP67	IP67
Length/Reel	5050mm 16.56ft	5050mm 16.56ft
Color temperature	● R ● G ● B	● R ● G ● B
Lumens	45lm/m 13lm/ft 110lm/m 33lm/ft 21lm/m 5lm/ft	38lm/m 11lm/ft 85lm/m 25lm/ft 20lm/m 6lm/ft

End cap

Ordinary End Cap

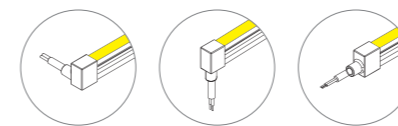

Mold end cap

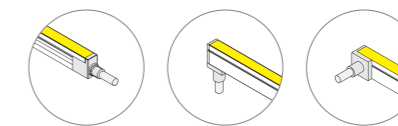

Injection-moulded endcap

*Cable can be bended to any direction.

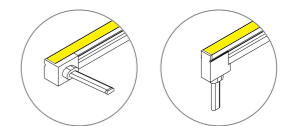

Dimension

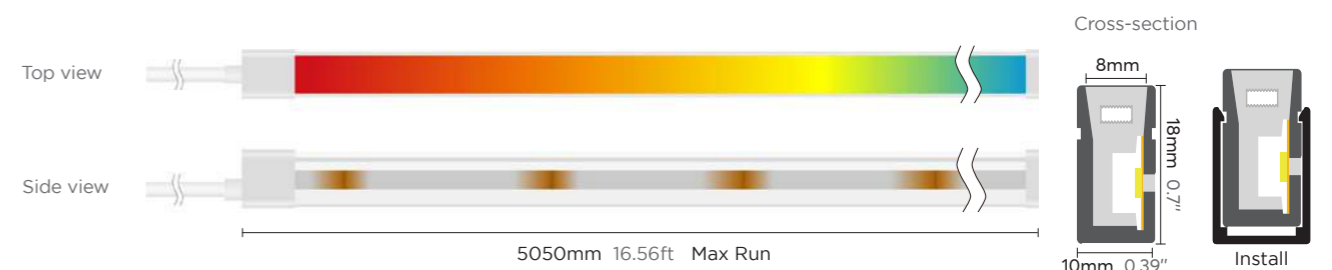

※ Please contact our sales for the latest details and certifications

Digital Colorful NEON

 Side bending

12x20mm RGBW DMX Controlled

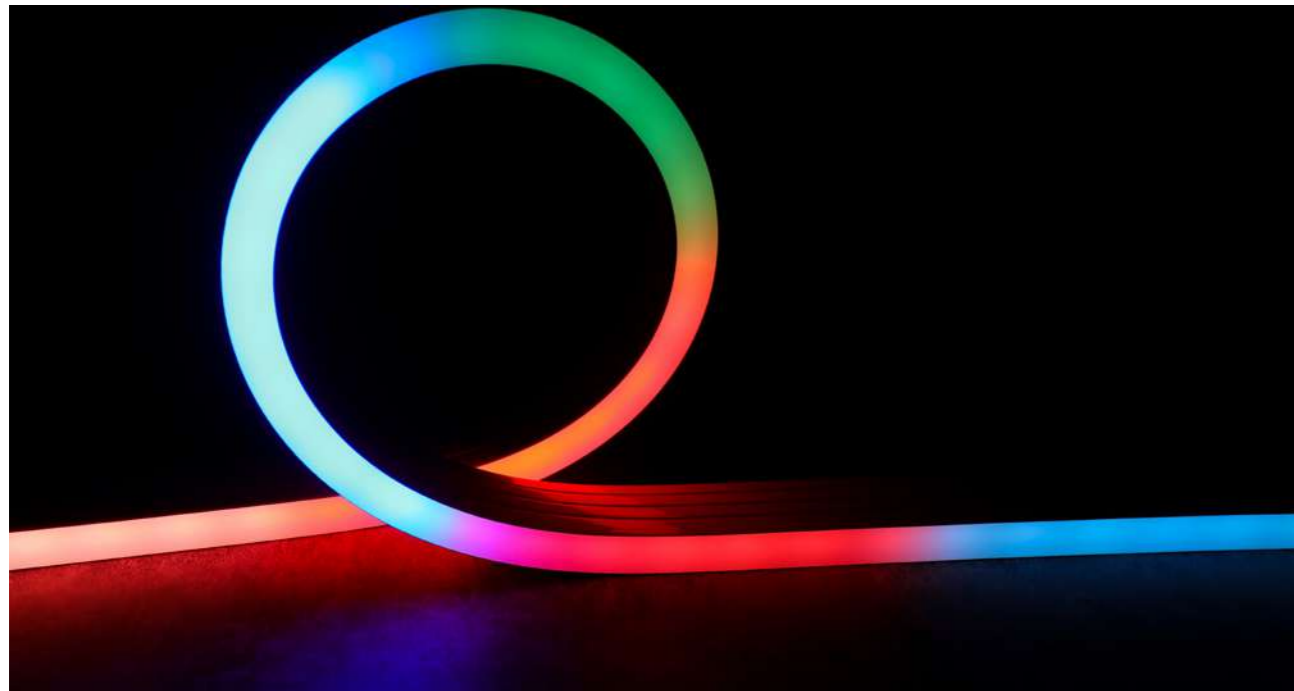

Seamless and uniform light output, dot free, Bendable at horizontal direction.
Built-in IC/SM18522PS, DMX512 signal protocol, single color, gradient color change, chasing, anima on and scene display.



Correct bending way

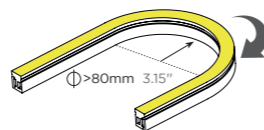

Accessories

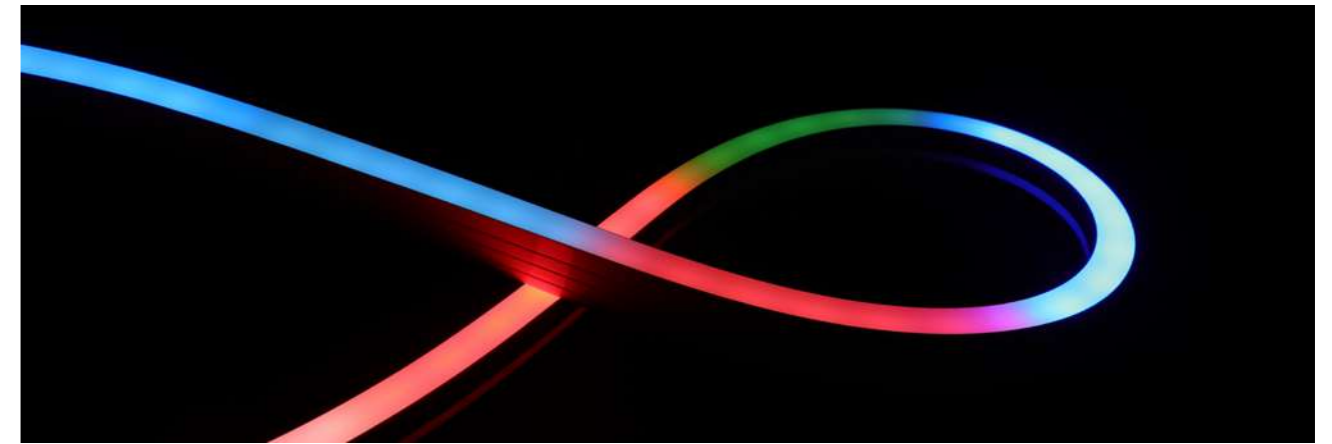

Technical Details 12x20mm DMX RGBW 12W					12x20mm DMX RGBW 14W			
Product NO.	FEN12DS-P7-G1 50ZRGB860 24VD56S7 1220L05				FEN14DS-P7-G1 50ZRGB840 24VD70S7 1220L05			
Voltage	DC24V				DC24V			
Power	12W/M 3.28W/ft				14W/M 4.26W/ft			
CRI	80 (5050LEDs)				80 (5050LEDs)			
Led Qty	56LEDs/M 17LEDs/ft				70LEDs/M 21LEDs/ft			
Cutting Length	100mm 3.93"				100mm 3.93"			
IP Grade	IP67				IP67			
Length/Reel	5050mm 16.56ft				5050mm 16.56ft			
Color temperature	● R	● G	● B	○ 6000K	● R	● G	● B	● 4000K
Lumens	25lm/m 8lm/ft	72lm/m 22m/ft	22lm/m 7lm/ft	122lm/m 37lm/ft	42lm/m 13lm/ft	99lm/m 30m/ft	28lm/m 9lm/ft	128lm/m 39lm/ft

End cap

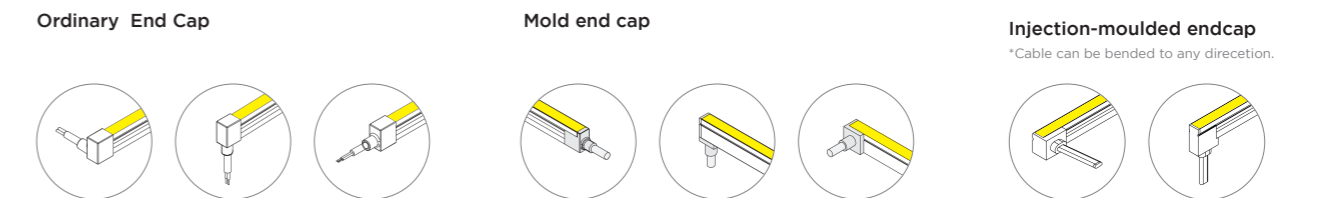

Dimension

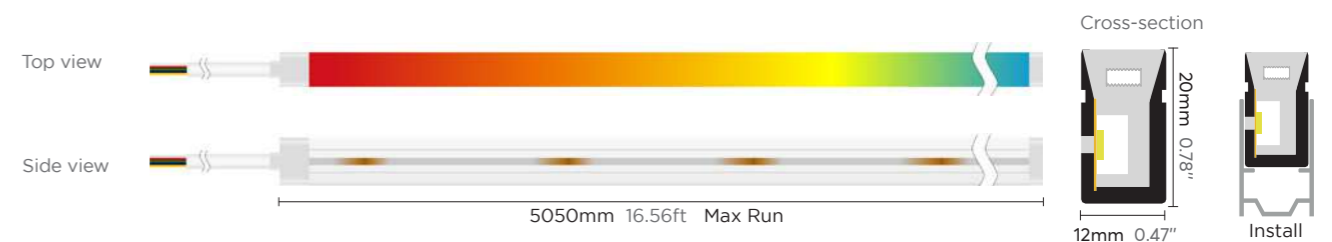

※ Please contact our sales for the latest details and certifications

Digital Colorful NEON

 Side bending

12x20mm RGBW SPI Controlled



Seamless and uniform light output, dot free.
Bendable at horizontal direction. IP67 protection.
Robust housing with high quality silicon, UV proof for true outdoor application.
Built-in IC/UCS2904B, SPI signal protocol, single color, gradient color change, chasing, anima on and scene display. 12 pixels /meter.



Correct bending way

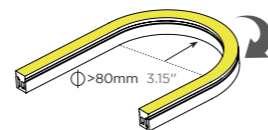

Accessories



Technical Details 1220 RGBW SPI

Product NO.	FEN12DS-P7-G2 50ZRGB830 24VS84S7 1220L05			
Voltage	DC24V			
Power	12W/M 3.28W/ft			
CRI	80 (5050LEDs)			
Led Qty	84LEDs/M 26LEDs/ft			
Cutting Length	83.3mm 3.27"			
IP Grade	IP67			
Length/Reel	5050mm 16.56ft			
Color temperature	● R	● G	● B	● 3000K
Lumens	32lm/m 10lm/ft	105lm/m 32m/ft	25lm/m 8lm/ft	100lm/m 30lm/ft

End cap

Ordinary End Cap

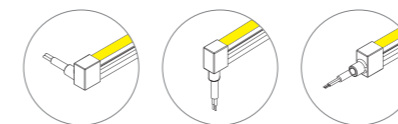

Mold end cap

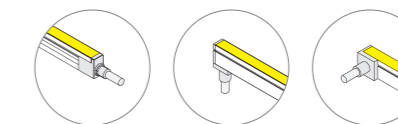

Injection-moulded endcap

*Cable can be bended to any direction.

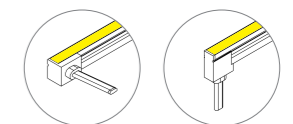

Dimension

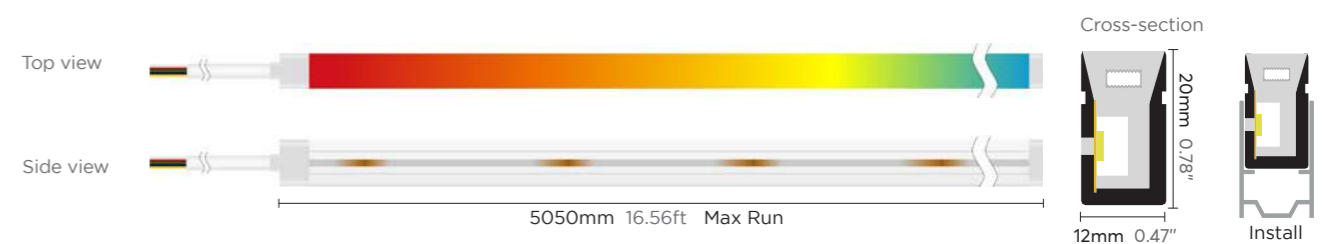

※ Please contact our sales for the latest details and certifications

Digital Colorful NEON

 Side bending

12x25mm RGBW DMX Controlled



12mm light-emitting surface, uniform light, dot free.
Seamless and uniform light output, dot free, Bendable at horizontal direction.
Built-in IC/SM18522PS, DMX512 signal protocol, single color, gradient color change, chasing, anima on and scene display.

Correct bending way

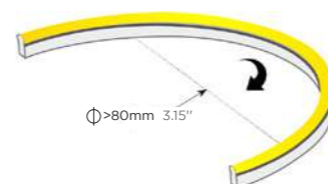

Accessories

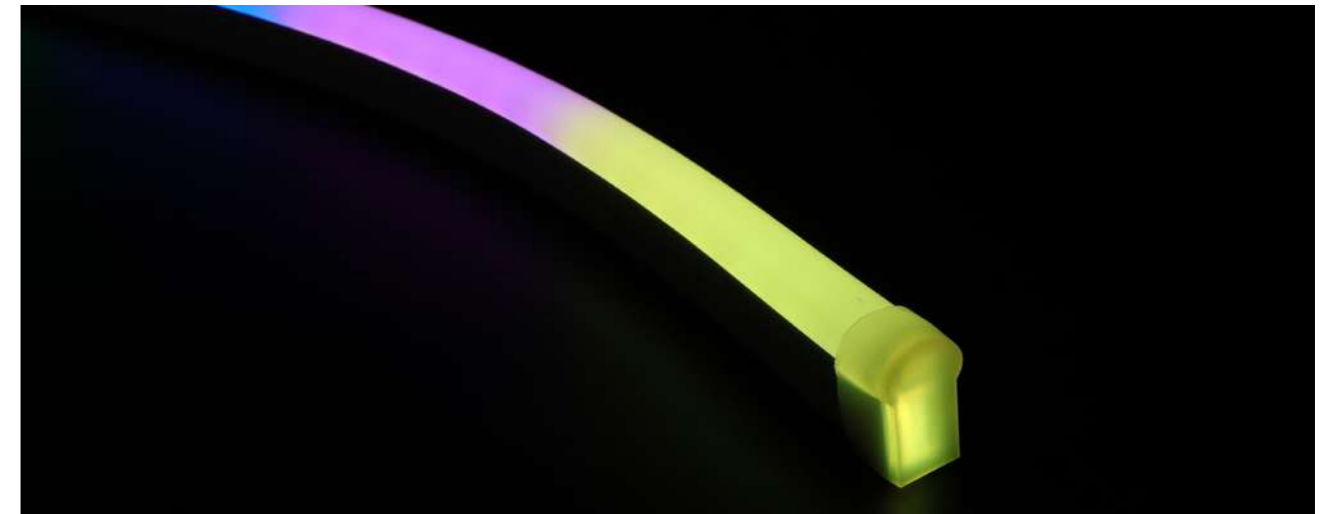

Technical Details 1225 RGBW DMX

Product NO.	FEN15DS-P7-G1 50ZRGB8X 24VD56S7 1225L05			
Voltage	DC24V			
Power	15W/M 4.57W/ft			
CRI	80 (5050LEDs)			
Led Qty	56LEDs/M 17LEDs/ft			
Cutting Length	50mm 1.97"			
IP Grade	IP67			
Length/Reel	5050mm 16.56ft			
Color temperature	● R	● G	● B	○ 6000K
Lumens	43lm/m 13lm/ft	111lm/m 34m/ft	25lm/m 8lm/ft	148lm/m 45lm/ft

End cap

Ordinary End Cap

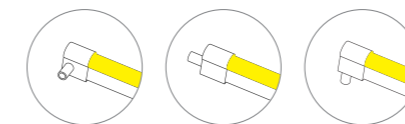

Dimension



※ Please contact our sales for the latest details and certifications

Digital Colorful NEON

 Side bending

16x20mm RGBW DMX Controlled

16mm light-emitting surface, uniform light, dot free.
RGBW Side emitting, meet a variety of side bending light shape.
Extrusion process, IP67, achieve temporary immersion.
With high quality silicon, UV proof for outdoor application.



Correct bending way

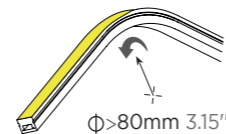

Accessories

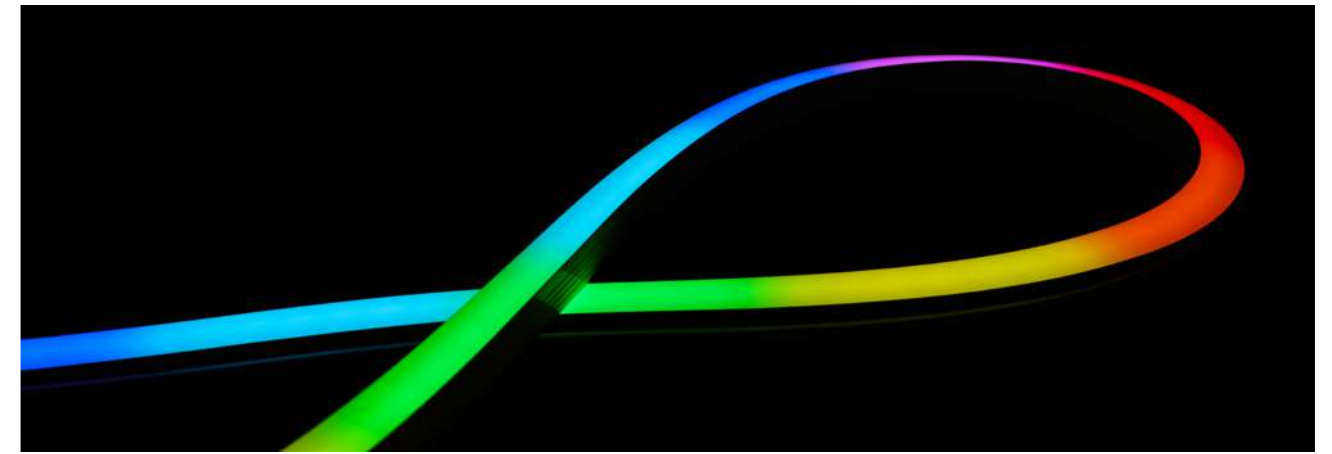

Technical Details **16x20mm DMX Controlled RGBW 15W**

Product NO.	FEN15DS-P7-G1 50ZRGB9x 24VD70S7 1620L05			
Voltage	DC24V			
Power	15W/M 4.57W/ft			
CRI	90 (5050LEDs)			
Led Qty	70LEDs/M 21LEDs/ft			
Cutting Length	100mm 3.94"			
IP Grade	IP67			
Length/Reel	5050mm 16.56ft			
Color temperature	● R	● G	● B	● 3000K
Lumens	45lm/m 14lm/ft	110lm/m 34lm/ft	30lm/m 9lm/ft	120lm/m 36lm/ft

End cap

Ordinary End Cap

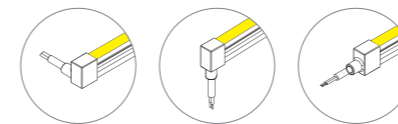

Dimension

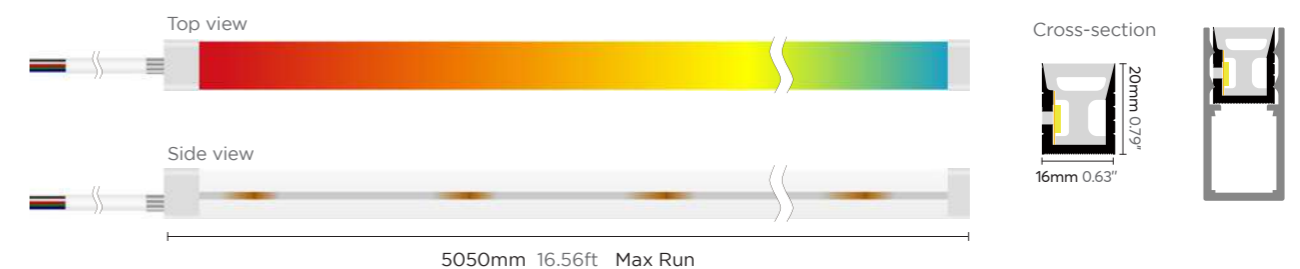



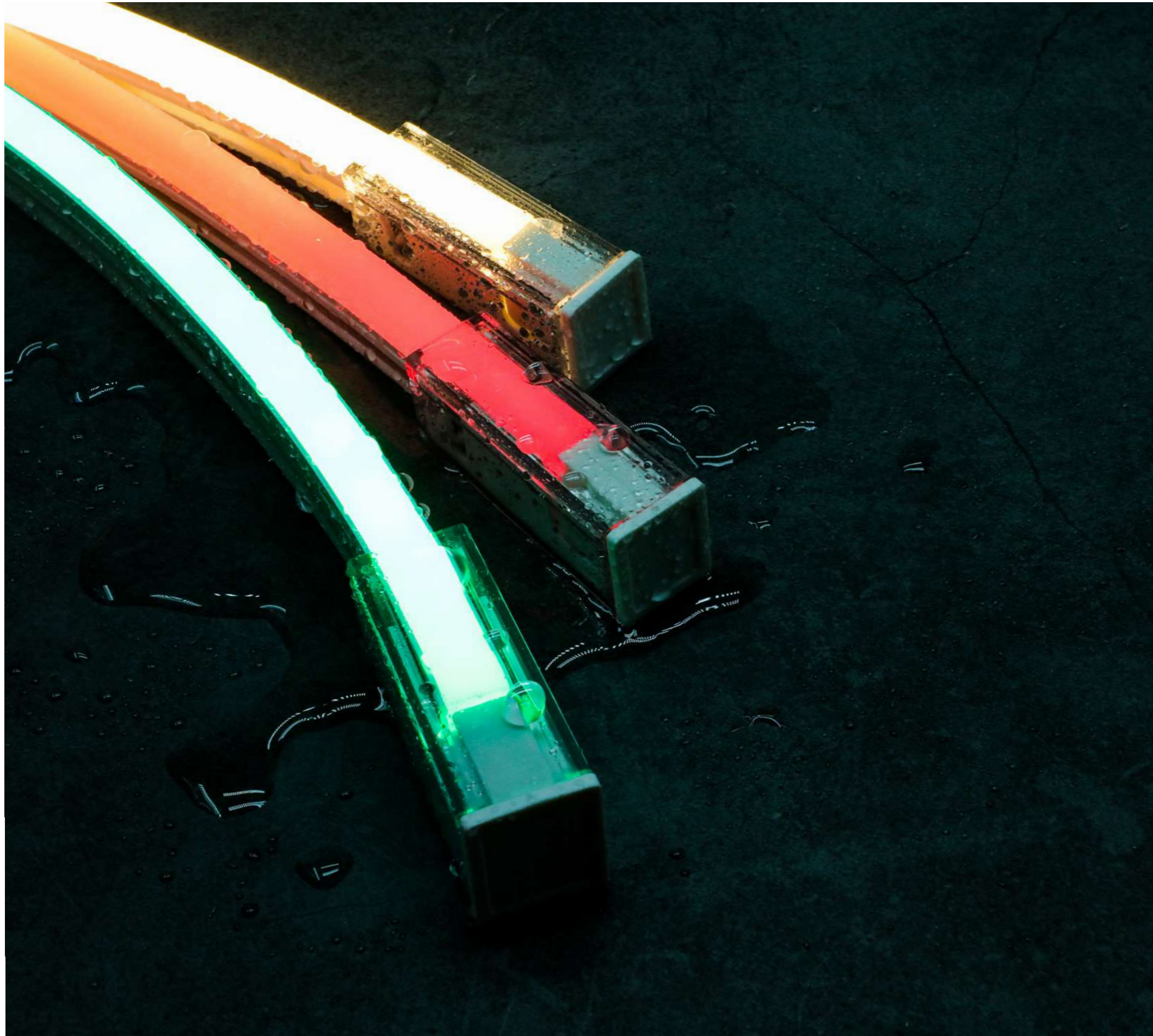



* Please contact our sales for the latest details and certifications







NEON Accessories

Connector

	Forward-wiring connector kit Single color	804-01-0185
	Left-wiring connector kit Single color	804-01-0186
	Forward-wiring connector kit Dual color	804-01-0187
	Left-wiring connector kit Dual color	804-01-0188
	Forward-wiring connector kit RGB	804-01-0189
	Left-wiring connector kit RGB	804-01-0190
	End-capping kit	804-01-0184





Cap

	End cap with hole	723-0507-092
	End cap	723-0507-093
	Bottom-wiring end cap	723-0507-096
	Input cap	723-0507-028

Clips

	Clips	701-0112-341
---------------------------------------------------------------------------------------	-------	--------------

Profile

	M Profile	913-01-1299-011
	2M	913-01-1299-010
	1M Track	913-01-0299-006
	0.5M Track	913-01-0299-007

COB SERIES

COB Honor (Weldless) Series
White (DC12/24V)
R/G/B/Y
High Efficacy COB
COB Ultra-Long (Up to 15m)

COB Essential Series
White (Weldless)
R/G/B/Y (Weldless)
Mini Cut
Free Cut
Mini PCB
Extra wide 30mm
COB Colorful
COB SPI Digital
220V COB High Voltage
Black Gold

Accessories & Installation
Connectors
IP Rating





COB Weldless/ Honor



	320LEDS/M 8W	400LEDS/M 12W	480LEDS/M 15W
Product NO.	FH08W-P0-G1 COB9X 24V320S W08RL05	FH12W-P0-G1 COB9X 24V400S W10RL05	FH15W-P0-G1 COB9X 24V480S W10RL05
Power	8W/M 2.4W/ft	12W/M 3.66W/ft	15W/M 4.57W/ft
Voltage	DC24V/DC12V	DC24V/DC12V	DC24V/DC12V
CRI	90	90	90
Led Qty	320LEDS/m 97LEDS/ft	400LEDS/M 121LEDS/ft	480LEDS/M 146LEDS/ft
Length/Reel	5004mm 16.41ft	5004mm 16.41ft	5004mm 16.41ft
Cutting Length	50mm 1.97"	100mm 3.92"	50mm 1.97"
IP Grade	IP20 / IP65 / IP68	IP20 / IP65 / IP68	IP20 / IP65 / IP68
Lumens			
● 2700K	745lm/m 227lm/ft	1060lm/m 323lm/ft	1350lm/m 411lm/ft
● 3000K	810lm/m 246lm/ft	1080lm/m 329lm/ft	1440lm/m 439lm/ft
● 4000K	840lm/m 256lm/ft	1285lm/m 391lm/ft	1440lm/m 439lm/ft
● 6500K	840lm/m 256lm/ft	1285lm/m 391lm/ft	1440lm/m 439lm/ft

Note: 'x' (CCT) = "27"(2700K) / "30"(3000K) / "40"(4000K) / "50"(5000K) / "60"(6000K), Please contact us for more information.

Dimension

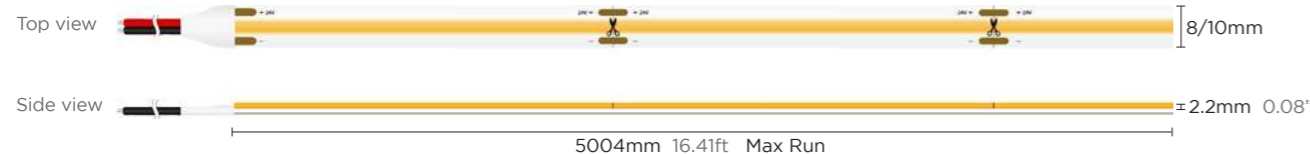

* Please contact our sales for the latest details and certifications



COB Weldless/ Honor/R/G/B/Y 480LEDS/M 10W 24V



Product NO. FH10M-P0-G1 COB_X 24V480S W10RL05

Technical Details

	Power	10W/M 3.04W/ft	Lumens	Peak WL
Voltage	DC24V		R 68lm/m 20lm/ft	Lp=660-670nm
CRI	-		G 1180lm/m 359lm/ft	Lp=520-530nm
Led Qty	480LEDS/M 146LEDS/ft		B 175lm/m 53lm/ft	Lp=455-465nm
Length/Reel	5004mm 16.41ft		Y 800lm/m 244lm/ft	Ld=588-598nm
Cutting Length	50mm 1.97"			
IP Grade	IP20 / IP65 / IP68			

Note: 'x' (CCT) = "27"(2700K) / "30"(3000K) / "40"(4000K) / "50"(5000K) / "60"(6000K), Please contact us for more information.

Dimension

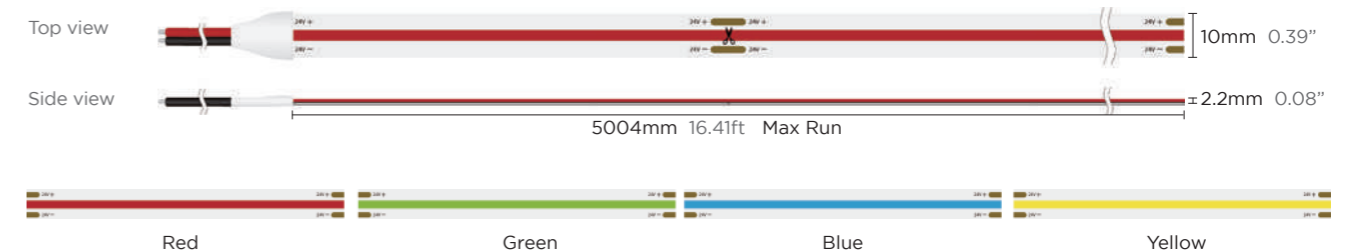

* Please contact our sales for the latest details and certifications

High Efficacy COB

Up to 140lm/W

Light efficiency increased by 30%



COB SERIES · HIGH EFFICACY COB

High Efficacy COB / Honor



	320LEDS/M 8W		480LEDS/M 15W	
Product NO.	FH08W-PO-G1 COBH9X 24V320S W08RL05		FH15W-PO-G1 COBH9X 24V480S W10RL05	
Power	8W/M 2.4W/ft		15W/M 4.57W/ft	
Voltage	DC24V		DC24V	
CRI	90		90	
Led Qty	320LEDS/m 97LEDS/ft		480LEDS/M 146LEDS/ft	
Length/Reel	5004mm 16.41ft		5004mm 16.41ft	
Cutting Length	50mm 1.97"		50mm 1.97"	
IP Grade	IP20 / IP65 / IP68		IP20 / IP65 / IP68	
Lumens				
● 2700K	960lm/m	293lm/ft	1800lm/m	549lm/ft
● 3000K	1040lm/m	317lm/ft	1890lm/m	576lm/ft
● 4000K	1120lm/m	341lm/ft	2025lm/m	617lm/ft
● 6500K	1120lm/m	341lm/ft	2025lm/m	617lm/ft

Note: 'x' (CCT) = *27*(2700K) / *30*(3000K) / *40*(4000K) / *50*(5000K) / *60*(6000K), Please contact us for more information.



High Efficacy COB / Essential



	320LEDS/M 8W		480LEDS/M 12W	
Product NO.	FE08W-PO-G1 COBH9X 24V320S W08RL05		FH10W-PO-G1 COB9x 24VC560S W10RL10	
Power	8W/M 2.4W/ft		12W/M 3.65W/ft	
Voltage	DC24V		DC24V	
CRI	90		90	
Led Qty	320LEDS/m 97LEDS/ft		480LEDS/M 146LEDS/ft	
Length/Reel	5004mm 16.41ft		5004mm 16.41ft	
Cutting Length	50mm 1.97"		50mm 1.97"	
IP Grade	IP20 / IP65 / IP68		IP20 / IP65 / IP68	
Lumens				
● 2700K	960lm/m	293lm/ft	1465lm/m	447lm/ft
● 3000K	1030lm/m	314lm/ft	1560lm/m	476lm/ft
● 4000K	1080lm/m	329lm/ft	1655lm/m	504lm/ft
● 6500K	1120lm/m	341lm/ft	1680lm/m	512lm/ft

Note: 'x' (CCT) = *27*(2700K) / *30*(3000K) / *40*(4000K) / *50*(5000K) / *60*(6000K), Please contact us for more information.

Dimension

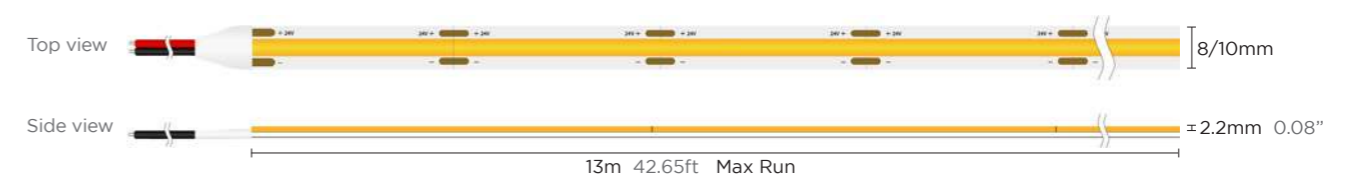

※ Please contact our sales for the latest details and certifications

COB SERIES · HIGH EFFICACY COB

COB Ultra-Long Up to 15m

15m Ultra-long Strip Driven by one end power supply.
The same brightness from end to end.
Dotless without cover, ideal for linear and indirect lighting.



10m 336LEDS/M 5.8W

15m 420LEDS/M 4.8W

Product NO.	FH06W-P0-G1 COB9x 24VC336S W08RL10	FH07W-P0-G1 COB9x 24VC420S W10RL15
Power	5.8W/M 1.77W/ft	4.8W/M 1.46W/ft
Voltage	DC24V	DC24V
CRI	90	90
Led Qty	336LEDS/m 102LEDS/ft	420LEDS/M 128LEDS/ft
Length/Reel	10m 32.8ft	15m 49.21ft
Cutting Length	41.67mm 1.64"	50mm 1.97"
IP Grade	IP20 / IP65 / IP68	IP20 / IP65 / IP68
Lumens		
● 2700K	455lm/m 139lm/ft	395lm/m 120lm/ft
● 3000K	465lm/m 142lm/ft	405lm/m 123lm/ft
● 4000K	490lm/m 149lm/ft	425lm/m 130lm/ft
● 6500K	490lm/m 149lm/ft	425lm/m 130lm/ft

Note:'x' (CCT) =*27*(2700K) / *30*(3000K) / *40*(4000K) / *50*(5000K) / *60*(6000K), Please contact us for more information.

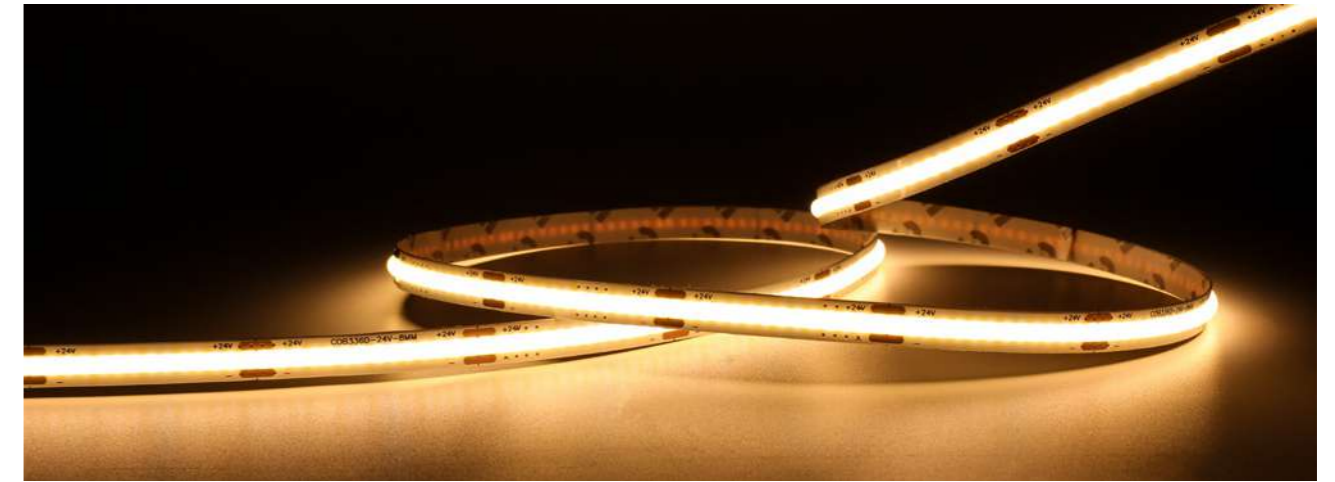

COB Ultra-Long / Honor



10m 560LEDS/M 9.6W

Product NO.	FH10W-P0-G1 COB9x 24VC560S W10RL10	
Power	9.6W/M 2.93W/ft	
Voltage	DC24V	
CRI	90	
Led Qty	560LEDS/M 170LEDS/ft	
Length/Reel	10m 32.8ft	
Cutting Length	25mm 0.98"	
IP Grade	IP20 / IP65 / IP68	
Lumens		
● 2700K	760lm/m	232lm/ft
● 3000K	770lm/m	235lm/ft
● 4000K	810lm/m	247lm/ft
● 6500K	810lm/m	247lm/ft

Note:'x' (CCT) =*27*(2700K) / *30*(3000K) / *40*(4000K) / *50*(5000K) / *60*(6000K), Please contact us for more information.

Dimension

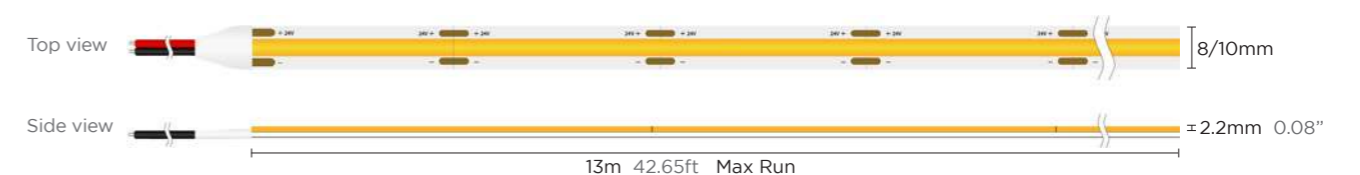

※ Please contact our sales for the latest details and certifications



COB Weldless/ Essential



320LEDS/M 8W

480LEDS/M 12W

Product NO.	FE08W-P0-G1 COB9X 24V320S W08RL05	FE12W-P0-G1 COB9X 24V480S W10RL05
Power	8W/M 2.4W/ft	12W/M 3.66W/ft
Voltage	DC24V	DC24V
CRI	90	90
Led Qty	320LEDS/M 97LEDS/ft	480LEDS/M 146LEDS/ft
Length/Reel	5004mm 16.41ft	5004mm 16.41ft
Cutting Length	50mm 1.96"	50mm 1.96"
IP Grade	IP20 / IP65 / IP68	IP20 / IP65 / IP68
Lumens		
● 2700K	736lm/m 224lm/ft	1044lm/m 318lm/ft
● 3000K	760lm/m 231lm/ft	1104lm/m 336lm/ft
● 4000K	864lm/m 263lm/ft	1212lm/m 369lm/ft
● 6500K	864lm/m 263lm/ft	1212lm/m 369lm/ft

Note: 'x' (CCT) = "27"(2700K) / "30"(3000K) / "40"(4000K) / "50"(5000K) / "60"(6000K), Please contact us for more information.

Dimension

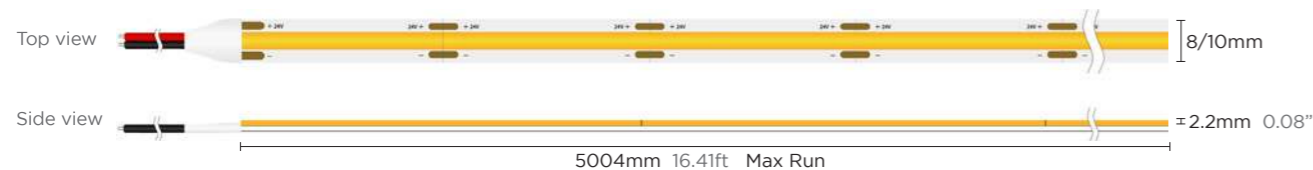

* Please contact our sales for the latest details and certifications



COB Weldless/Essential/R/G/B/Y 480LEDS/M 10W 24V



Product NO. FE10M-P0-G1 COBX 24V480S W08RL05

Technical Details

Power	10W/M 3.04W/ft	Lumens		Peak WL
Voltage	DC24V	R	70lm/m 21lm/ft	Lp=660-670nm
CRI	-	G	1190lm/m 363lm/ft	Lp=520-530nm
Led Qty	480LEDS/M 146LEDS/ft	B	150lm/m 46lm/ft	Lp=455-465nm
Length/Reel	5004mm 16.41ft	Y	900lm/m 274lm/ft	Ld=588-598nm
Cutting Length	50mm 1.97"			
IP Grade	IP20 / IP65 / IP68			

Note: 'x' (CCT) = "27"(2700K) / "30"(3000K) / "40"(4000K) / "50"(5000K) / "60"(6000K), Please contact us for more information.

Dimension

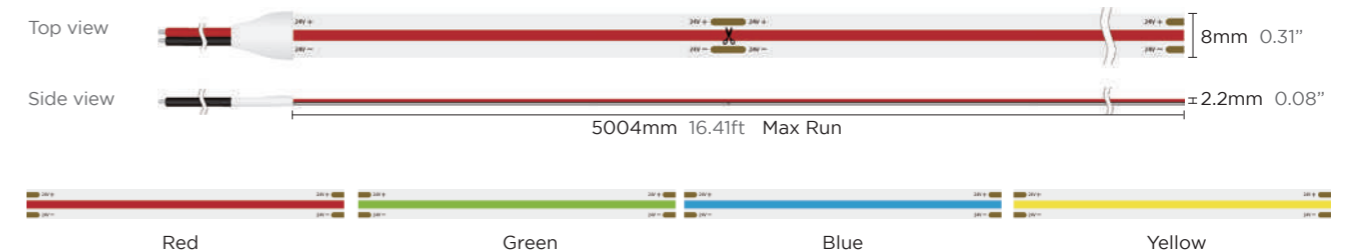

* Please contact our sales for the latest details and certifications



COB Essential/Mini cut



	300LEDS/M 10W	600LEDS/M 10W
Product NO.	FE10W-P0-G1 COB9x 12V300S W10L05	FE10W-P0-G1 COB9x 24V600S W10L05
Power	10W/M 3.04W/ft	10W/M 3.04W/ft
Voltage	DC12V	DC24V
CRI	90	90
Led Qty	300LEDS/M 91LEDS/ft	600LEDS/M 183LEDS/ft
Length/Reel	2500mm 8.36ft	5004mm 16.41ft
Cutting Length	10mm 0.39"	10mm 0.39"
IP Grade	IP20	IP20
Lumens		
● 2700K	650lm/m 198lm/ft	680lm/m 207lm/ft
● 3000K	720lm/m 219lm/ft	750lm/m 228lm/ft
● 4000K	850lm/m 259lm/ft	900lm/m 274lm/ft
● 6500K	800lm/m 259lm/ft	820lm/m 250lm/ft

Note: 'x' (CCT) = °27°(2700K) / °30°(3000K) / °40°(4000K) / °50°(5000K) / °60°(6000K), Please contact us for more information.

Dimension

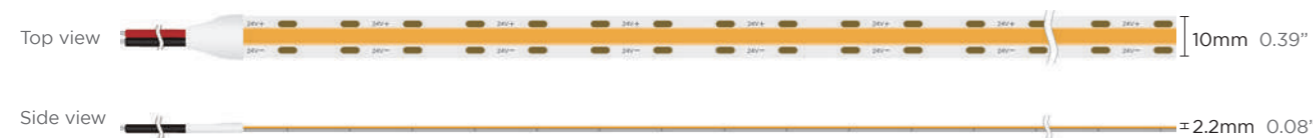

* Please contact our sales for the latest details and certifications

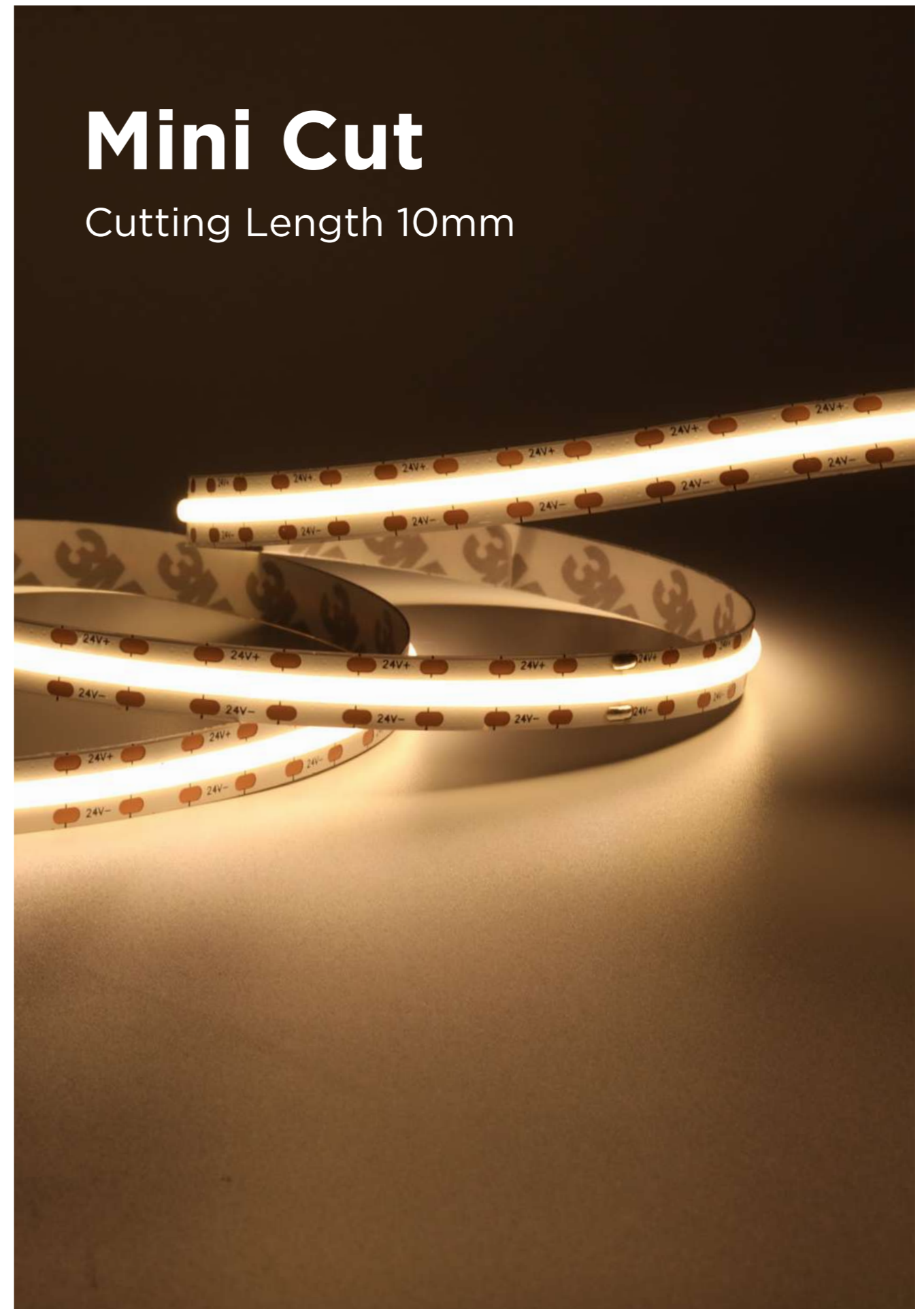

Mini Cut

Cutting Length 10mm

Free cutting

Cut any where.
Dot-free, ideal for linear or even direct illumination.

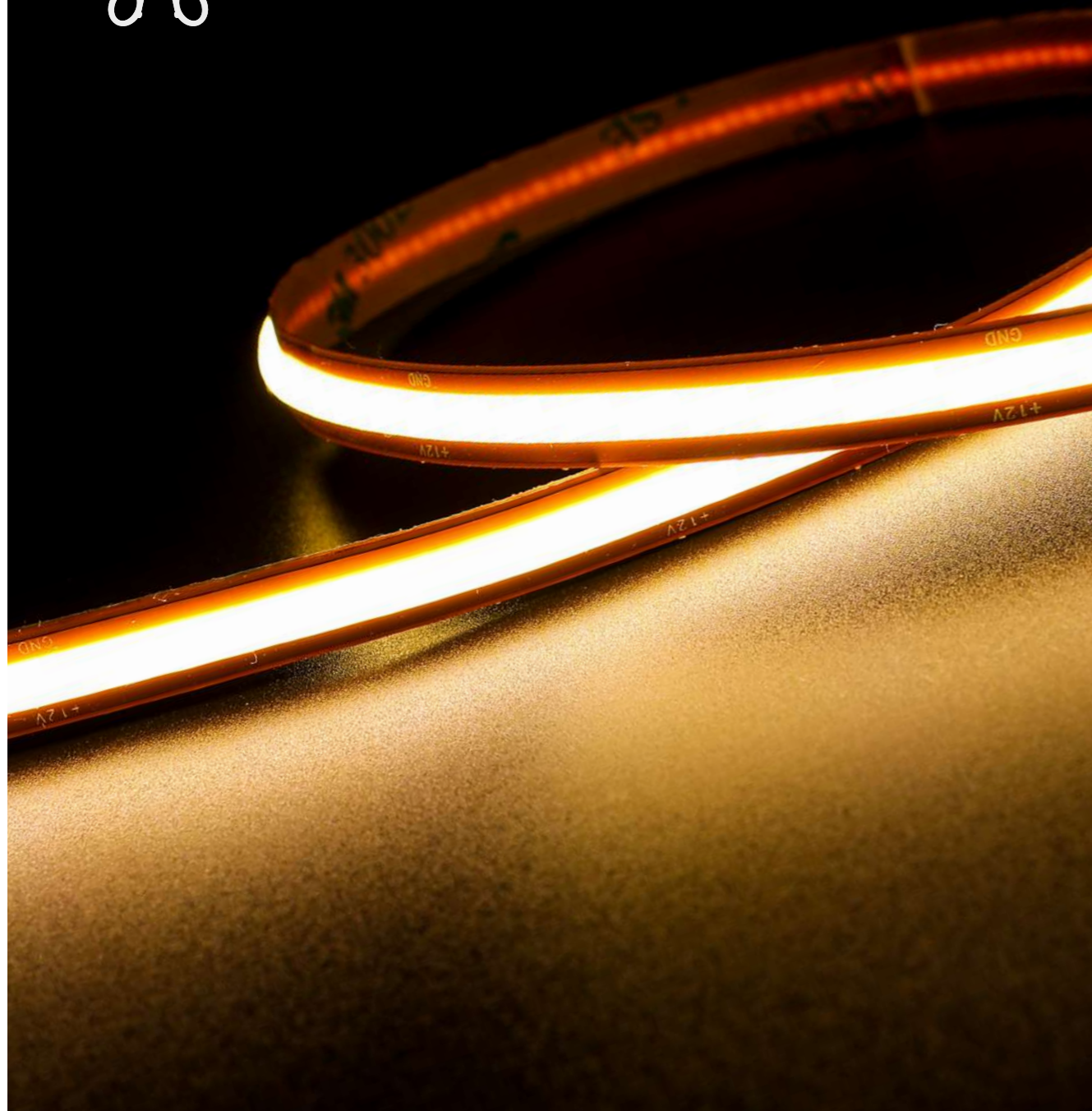
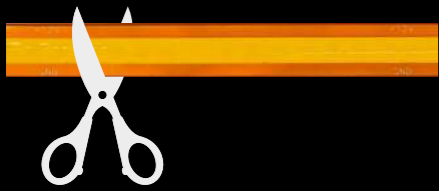

COB Free cut



	12V 528LEDS/M 13W		24V 528LEDS/M 13W	
Product NO.	FE13W-P0-G1 COB9x 12V528S1 W08L05		FE13W-P0-G1 COB9x 24V528S1 W08L05	
Power	13W/M 3.96W/ft		13W/M 3.96W/ft	
Voltage	DC12V		DC24V	
CRI	90		90	
Led Qty	528LEDs/m 161LEDs/ft		528LEDs/m 161LEDs/ft	
Length/Reel	5004mm 16.41ft		5004mm 16.41ft	
Cutting Length	Free cut		Free cut	
IP Grade	IP20 / IP65 / IP68		IP20 / IP65 / IP68	
Lumens				
● 3000K	1170lm/m	357lm/ft	890lm/m	271lm/ft
● 4000K	1200lm/m	366lm/ft	910lm/m	277lm/ft
● 6500K	1200lm/m	366lm/ft	910lm/m	277lm/ft

Note: 'x' (CCT) = *27*(2700K) / *30*(3000K) / *40*(4000K) / *50*(5000K) / *60*(6000K), Please contact us for more information.

Dimension



※ Please contact our sales for the latest details and certifications

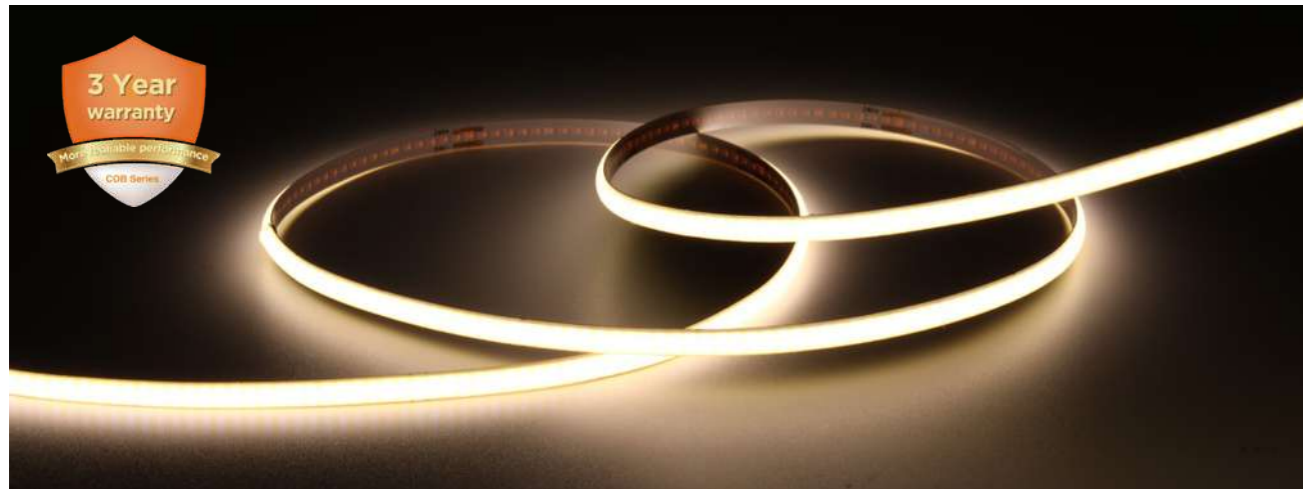

COB Essential/Mini PCB



	PCB 4mm / 4W	PCB 6mm / 6W
Product NO.	FE04W-P0-G1 COB9X 24V480S W04L2D5	FE06W-P0-G1 COB9X 24V480S W06L05
Power	4W/M 1.21W/ft	6W/M 1.82W/ft
Voltage	DC24V	DC24V
CRI	90	90
Led Qty	480LEDs/M 146LEDs/ft	480LEDs/M 146LEDs/ft
Length/Reel	2500mm 8.36ft	5004mm 16.41ft
Cutting Length	50mm 1.97"	50mm 1.97"
IP Grade	IP20	IP20
Lumens		
● 2700K	350lm/m 106lm/ft	480lm/m 146lm/ft
● 3000K	380lm/m 115lm/ft	580lm/m 176lm/ft
● 4000K	420lm/m 128lm/ft	630lm/m 192lm/ft
● 6500K	400lm/m 121lm/ft	600lm/m 182lm/ft

Note: 'x' (CCT) = "27"(2700K) / "30"(3000K) / "40"(4000K) / "50"(5000K) / "60"(6000K), Please contact us for more information.

Dimension



* Please contact our sales for the latest details and certifications

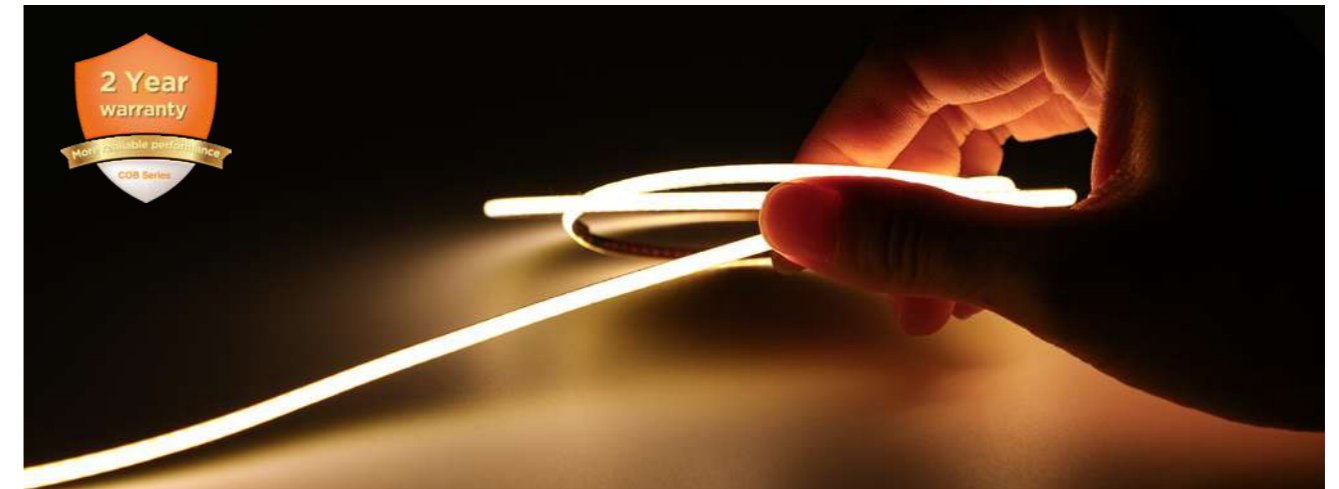

COB Essential/Mini PCB



	PCB 3mm / 7W	PCB 5mm / 7W
Product NO.	FE07W-P0-G1 COB9x 24V384S W03L2D5	FE07W-P0-G1 COB9x 24V384S W05L05
Power	7W/M 2.13W/ft	7W/M 2.13W/ft
Voltage	DC24V	DC24V
CRI	90	90
Led Qty	384LEDs/M 117LEDs/ft	384LEDs/M 117LEDs/ft
Length/Reel	2500mm 8.36ft	5004mm 16.41ft
Cutting Length	41.7mm 1.64"	41.7mm 1.64"
IP Grade	IP20	IP20
Lumens		
● 2700K	630lm/m 192lm/ft	630lm/m 192lm/ft
● 3000K	660lm/m 201lm/ft	660lm/m 201lm/ft
● 4000K	700lm/m 213lm/ft	700lm/m 213lm/ft
● 6500K	740lm/m 226lm/ft	740lm/m 226lm/ft

Note: 'x' (CCT) = "27"(2700K) / "30"(3000K) / "40"(4000K) / "50"(5000K) / "60"(6000K), Please contact us for more information.

Dimension



* Please contact our sales for the latest details and certifications

Extra wide 30mm

Spots free without cover, ideal for linear and indirect lighting.
High Efficacy RA>90, up to 120lm/W.



Emitting width 24mm

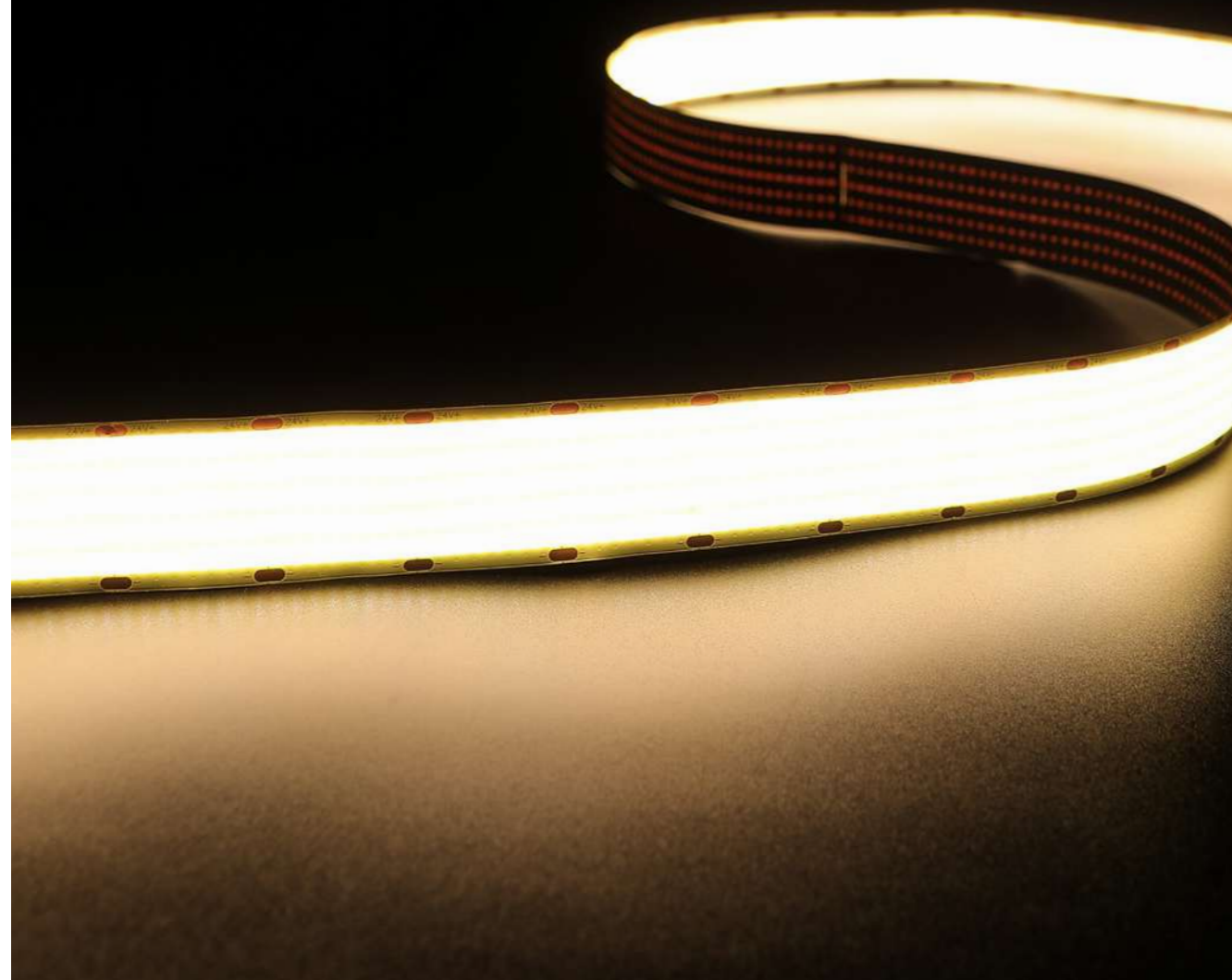

COB Extra wide 30mm



24V 1600LEDS/M 30W

Product NO.	FE36W-P0-G1 COB9x 24V1600S W30L05	
Power	36W/M 10.97W/ft	
Voltage	DC12V	
CRI	90	
Led Qty	1600LEDs/m 487LEDs/ft	
Length/Reel	5004mm 16.41ft	
Cutting Length	25mm	
IP Grade	IP20	
Lumens		
● 3000K	4250lm/m	1296lm/ft
● 4000K	4350lm/m	1326lm/ft
● 6500K	4350lm/m	1326lm/ft

Note: 'x' (CCT) = "27"(2700K) / "30"(3000K) / "40"(4000K) / "50"(5000K) / "60"(6000K), Please contact us for more information.

Dimension

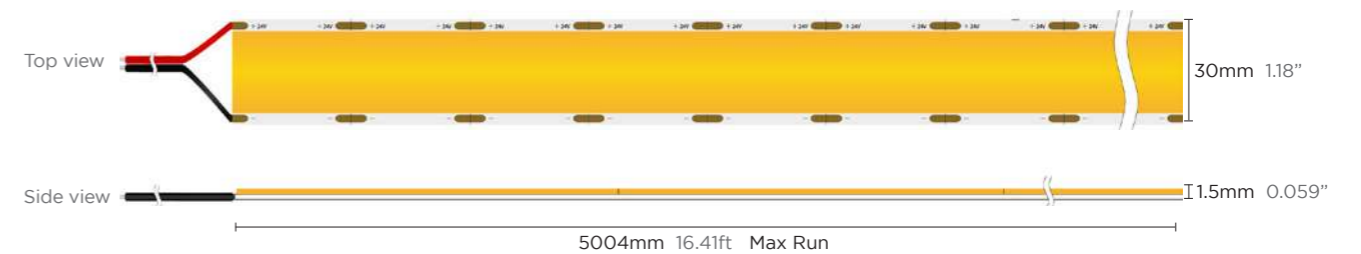

* Please contact our sales for the latest details and certifications



COB Essential/Tunable CCT



3 Year warranty 840LEDS/M 20W

Product NO.	FE20C-P0-G1 COB927965 24V840S W10L05	FE14C-P0-G1 COB92765 24V608S W10L05
Power	20W/M 6.09W/ft	14W/M 4.27W/ft
Voltage	DC24V	DC24V
CRI	90	90
Led Qty	840LEDS/M 256LEDS/ft	608LEDS/M 186LEDS/ft
Length/Reel	5004mm 16.41ft	5004mm 16.41ft
Cutting Length	50mm 1.97"	26.3mm 1.03"
IP Grade	IP20 / IP65 / IP68	IP20 / IP65 / IP68
Lumens		
● 2700K	840lm/m 256lm/ft	630lm/m 192lm/ft
6500K	1000lm/m 305lm/ft	770lm/m 235lm/ft

Note: 'x' (CCT) = "27"(2700K) / "30"(3000K) / "40"(4000K) / "50"(5000K) / "60"(6000K), Please contact us for more information.

Dimension

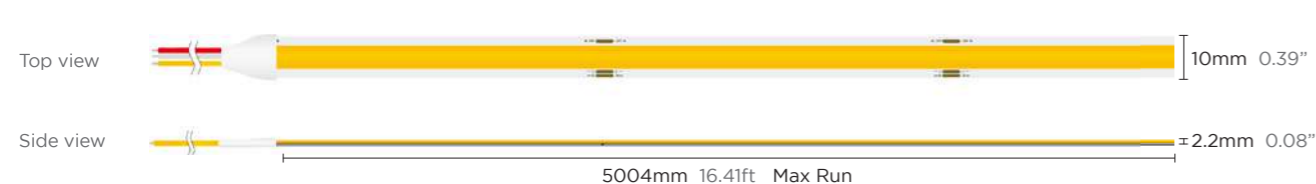

* Please contact our sales for the latest details and certifications



COB Essential/RGB



2 Year warranty 576LEDS/M 14W

2 Year warranty 768LEDS/M 14W

3 Year warranty 840LEDS/M 14W

Product NO.	FE14C-P0-G1 COBRGB 24V576S W10L05	FE14C-P0-G1 COBRGB 24V768S W10L05	FE14C-P0-G1 COBRGB 24V840S W10L05
Power	14W/M 4.27W/ft	14W/M 4.27W/ft	14W/M 4.27W/ft
Voltage	DC24V	DC24V	DC24V
CRI	-	-	-
Led Qty	576LEDS/M 176LEDS/ft	768LEDS/M 233LEDS/ft	840LEDS/M 256LEDS/ft
Length/Reel	5004mm 16.41ft	5004mm 16.41ft	5004mm 16.41ft
Cutting Length	62.5mm 2.46"	31.26mm 1.23"	25mm 0.98"
IP Grade	IP20 / IP65 / IP68	IP20 / IP65 / IP68	IP20 / IP65 / IP68
Lumens			
R	160lm/m 49lm/ft	180lm/m 55lm/ft	120lm/m 36lm/ft
G	330lm/m 100lm/ft	340lm/m 104lm/ft	400lm/m 122lm/ft
B	60lm/m 18lm/ft	80lm/m 24lm/ft	55lm/m 17lm/ft

Dimension

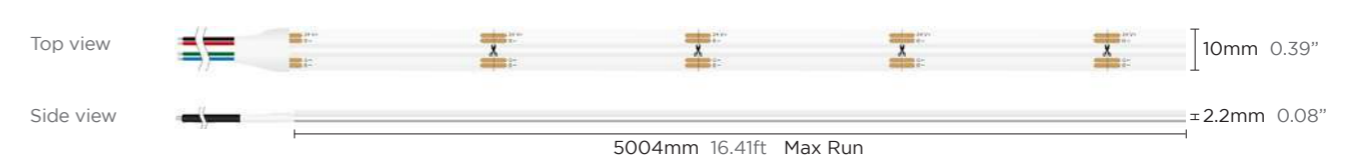

* Please contact our sales for the latest details and certifications

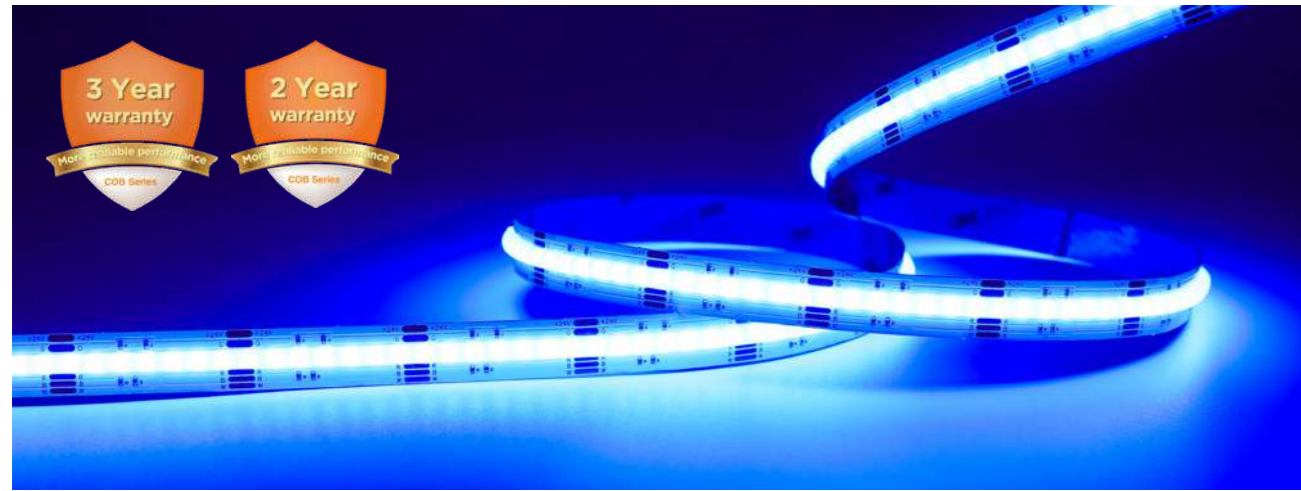

COB Essential/RGBW



784LEDS/M 19W

840LEDS/M 18W

Product NO.	FE19C-P0-G1 COBRGBW 24V784S W12L05	FE18C-P0-G1 COBRGBW 24V840S W12L05
Power	19W/M 5.79W/ft	18W/M 5.48W/ft
Voltage	DC24V	DC24V
CRI	-	-
Led Qty	784LEDS/M 239LEDS/ft	840LEDS/M 256LEDS/ft
Length/Reel	5004mm 16.41ft	5004mm 16.41ft
Cutting Length	71.4mm 2.81"	33.33mm 1.31"
IP Grade	IP20 / IP65 / IP68	IP20 / IP65 / IP68

Lumens

R	160lm/m 49lm/ft	110lm/m 33lm/ft
G	415lm/m 127lm/ft	450lm/m 137lm/ft
B	85lm/m 26lm/ft	60lm/m 18lm/ft
W	485lm/m 148lm/ft	480lm/m 146lm/ft

Dimension



* Please contact our sales for the latest details and certifications

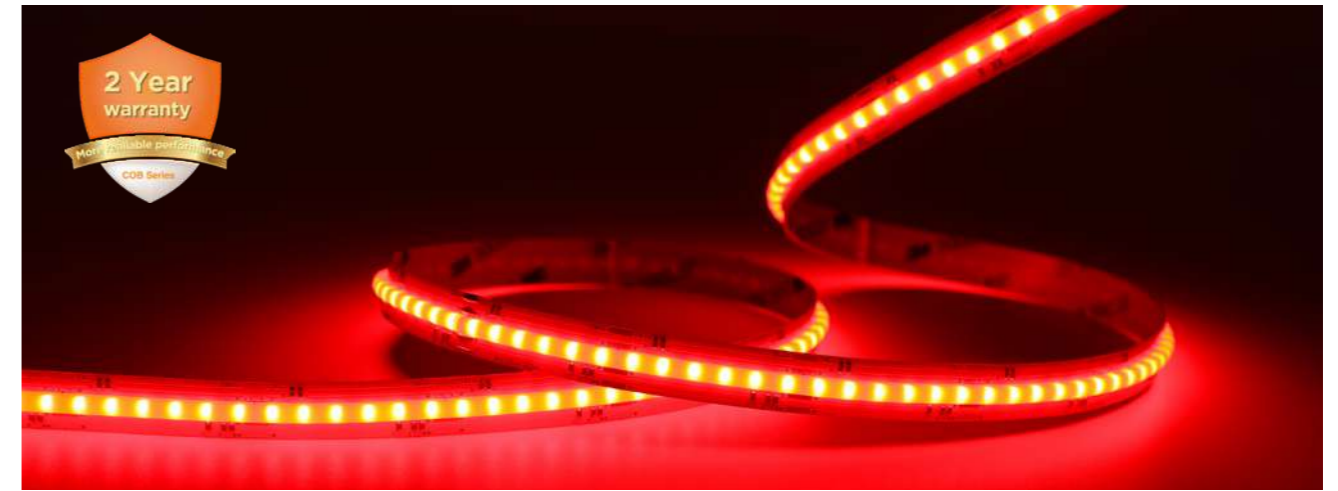

COB Essential/RGBWC



840LEDS/M 21W

Product NO.	FE21C-P0-G1 COBRGBWC 24V840S W12L05
Power	21W/M 6.4W/ft
Voltage	DC24V
CRI	-
Led Qty	840LEDS/M 256LEDS/ft
Length/Reel	5004mm 16.41ft
Cutting Length	35.7mm 1.4"
IP Grade	IP20 / IP65 / IP68

Lumens

R	130lm/m 40lm/ft
G	310lm/m 95lm/ft
B	65lm/m 20lm/ft
2700K	380lm/m 116lm/ft
6500K	390lm/m 119lm/ft

Dimension

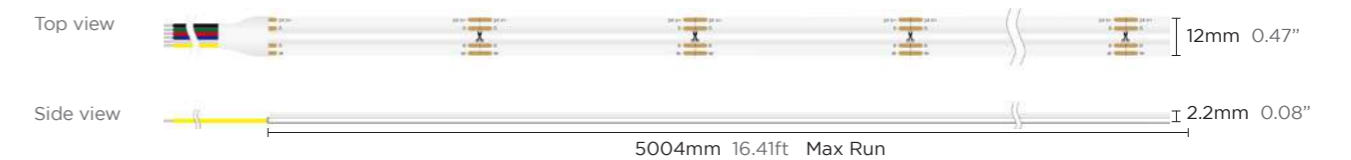

* Please contact our sales for the latest details and certifications

COB SPI Digital White

Colors jump & gradual changings can be realized by controller coding.
Varying color programs can be controlled by 12 pixels per meter.
SPI control IC-WS2811

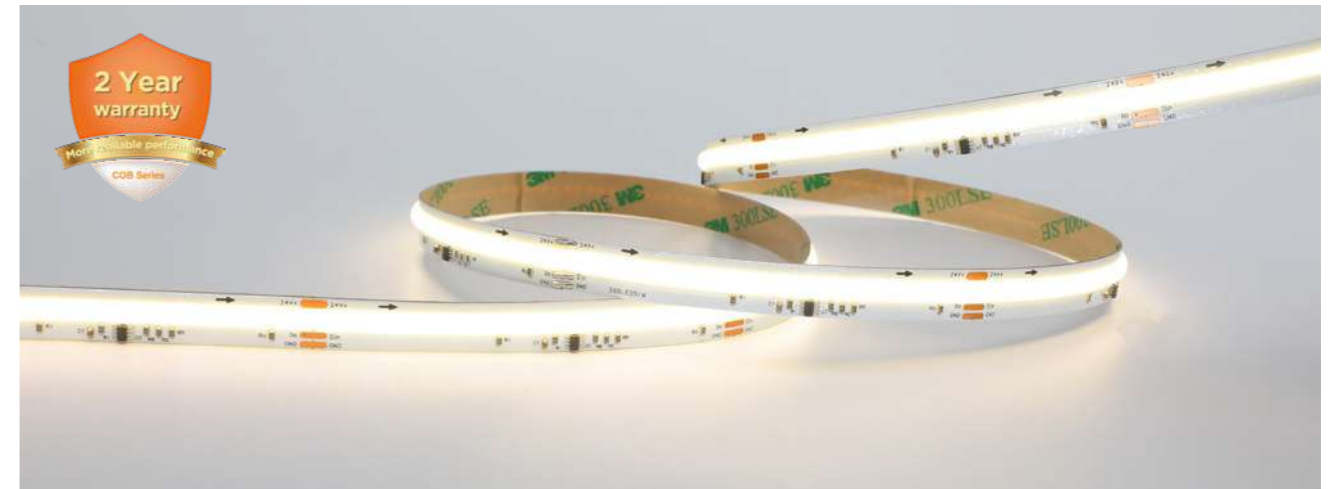
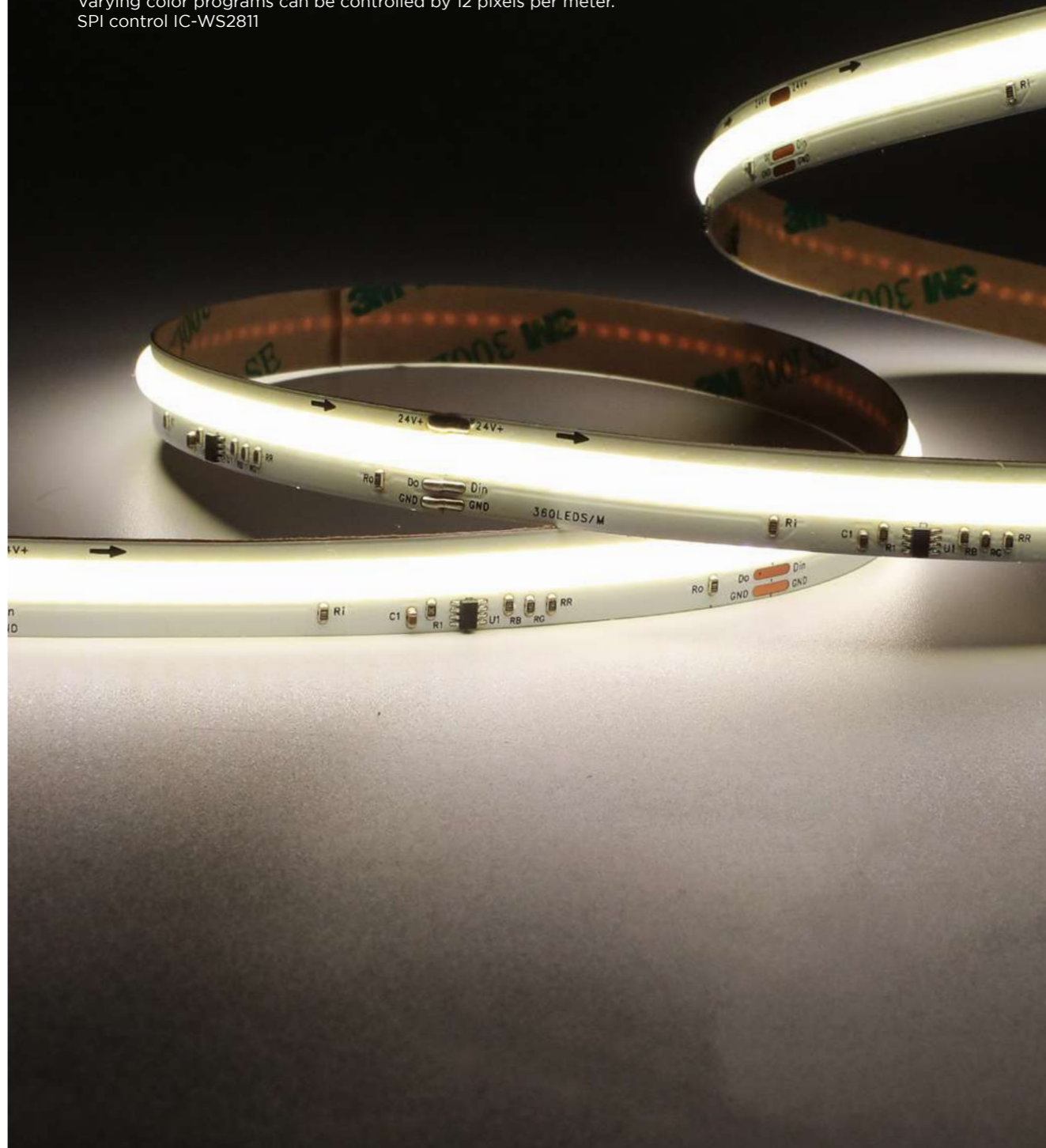

COB Essential/SPI Digital White



360LEDS/M 12W

Product NO.	FE12D-P0-G1 COB9xx 24VS360S W10L05
Power	12W/M 3.66W/ft
Voltage	DC24V
CRI	90
Led Qty	360LEDS/M 110LEDS/ft
Length/Reel	5004mm 16.41ft
Cutting Length	83.33mm 3.28"
IP Grade	IP20 / IP65 / IP68
Lumens	
● 3000K	660lm/m 201lm/ft
● 4000K	720lm/m 220lm/ft
● 6500K	720lm/m 220lm/ft

Note:'x' (CCT) ="27"(2700K) / "30"(3000K) / "40"(4000K) / "50"(5000K) / "60"(6000K), Please contact us for more information.

Dimension

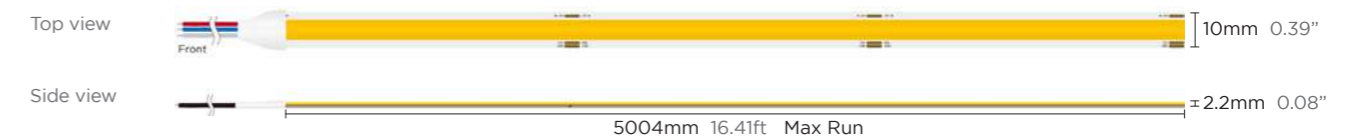

* Please contact our sales for the latest details and certifications

COB SPI Digital RGB/RGBW

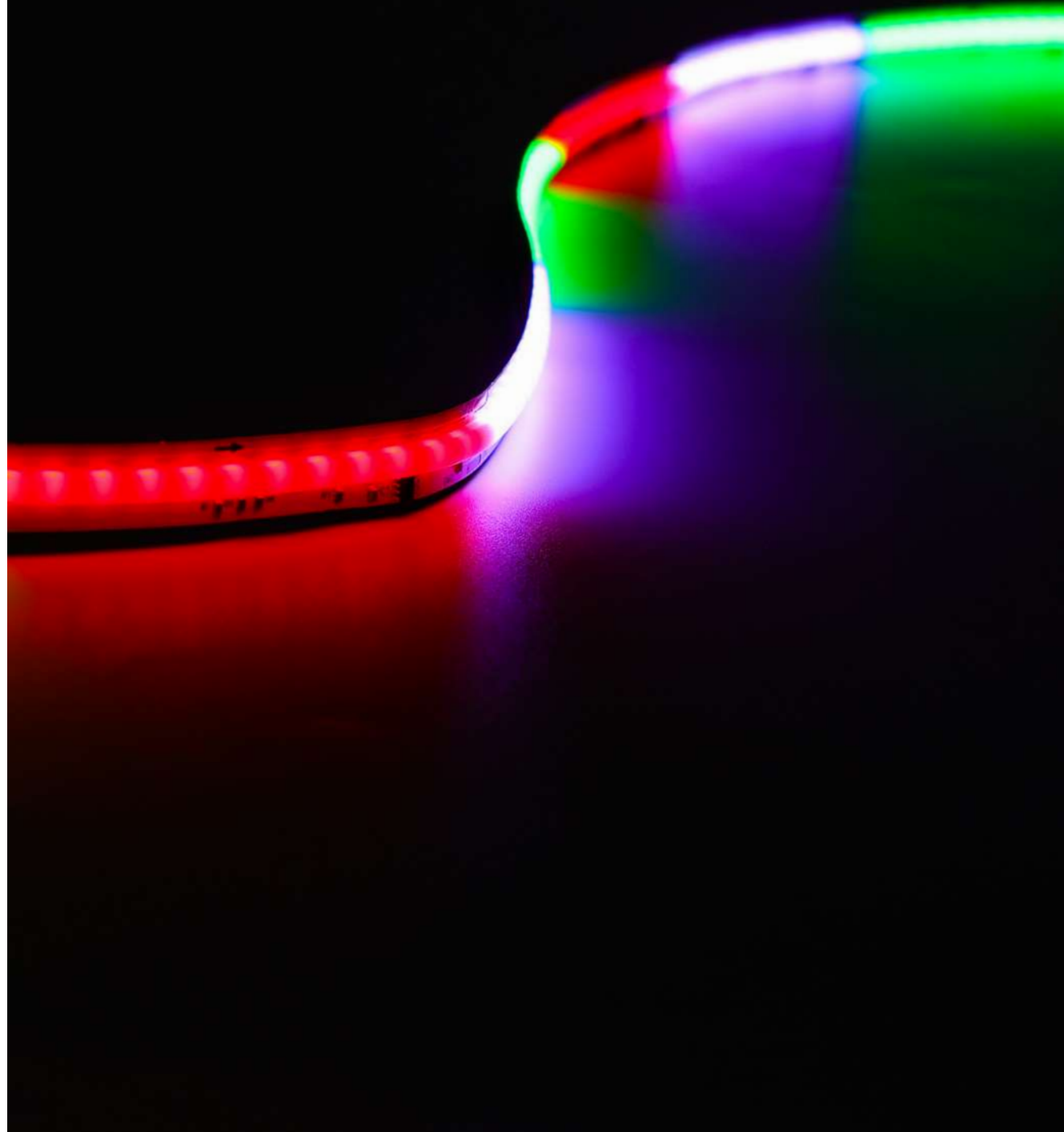

COB Essential/SPI RGB/RGBW



	RGB 576LEDS/M 18W	RGBW 784LEDS/M 21W
Product NO.	FE18D-P0-G1 COBRGB 24VS576S W10L05	FE21D-P0-G1 COBRGBW 24VS784S W10L05
Power	18W/M 5.49W/ft	21W/M 6.4W/ft
Voltage	DC24V	DC24V
CRI	/	/
Led Qty	576LEDS/M 176LEDS/ft	784LEDS/M 239LEDS/ft
Length/Reel	5004mm 16.41ft	5004mm 16.41ft
Cutting Length	62.5mm 2.46"	71.42mm 2.81"
IP Grade	IP20 / IP65 / IP68	IP20 / IP65 / IP68
Lumens		
R	114lm/m 35lm/ft	66lm/m 20lm/ft
G	433lm/m 132lm/ft	435lm/m 133lm/ft
B	60lm/m 18lm/ft	69lm/m 21lm/ft
W	/ /	340lm/m 104lm/ft

Dimension

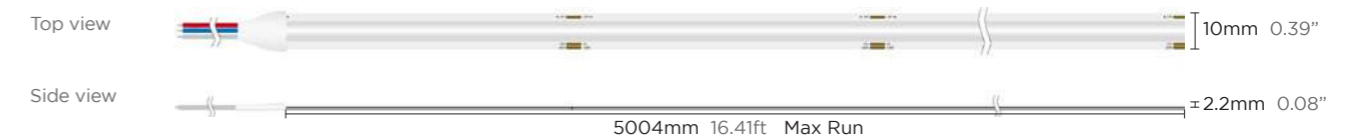

* Please contact our sales for the latest details and certifications

220V COB High Voltage

Perfect color control.
Cutttable, large bending degree, easy installation.
Ultra-long, up to 50 meters one end feed.

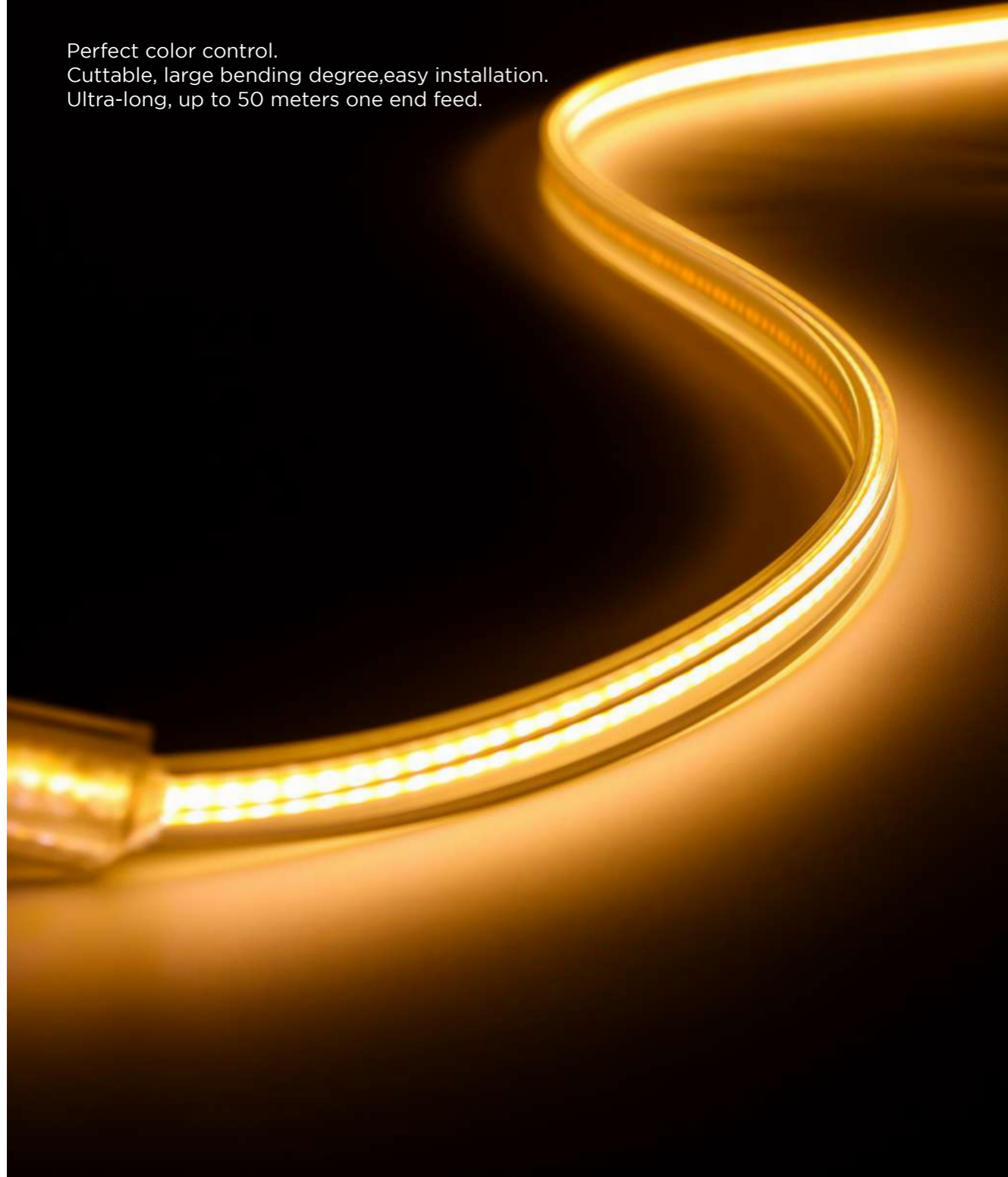

COB 220V COB High Voltage



220V 288LEDS/M 8W

Product NO.	FE08W-P5-G2 COB8x 220V288S 1206L50	Lumens
Power	8W/M	● 3000K 525lm/m
Voltage	DC220V	● 4000K 600lm/m
CRI	80	6500K 600lm/m
Led Qty	288LEDs/m	
Length/Reel	50m	
Cutting Length	500mm	
IP Grade	IP65	

Note: 'x' (CCT) = *27*(2700K) / *30*(3000K) / *40*(4000K) / *50*(5000K) / *60*(6000K), Please contact us for more information.

Dimension

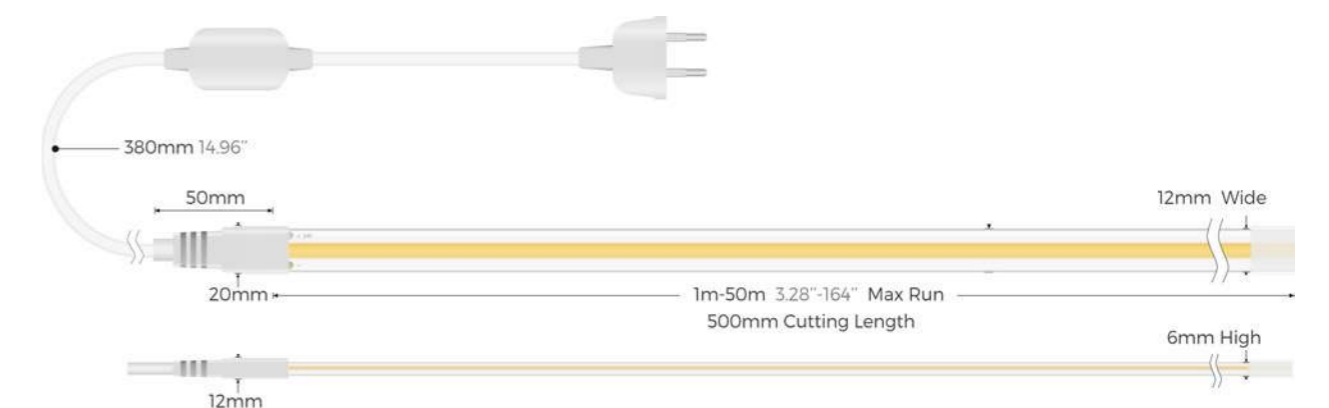

* Please contact our sales for the latest details and certifications

Black Gold

Black and gold collocation, the appearance of
High-end atmosphere
Easy to install and preserve

IP67



COB NEON/Black Gold 320LEDS/M 8W 24V



Product NO. FE08W-P7-G3 COB9X 24V320S W08L05

Technical Details

Power	8W/M 2.43W/ft	Lumens		
Voltage	DC24V	● 2700K	480lm/m	146lm/ft
CRI	90	● 3000K	520lm/m	158lm/ft
Led Qty	320LEDS/M 97LEDS/ft	● 4000K	650lm/m	198lm/ft
Length/Reel	5050mm 16.56ft	● 6500K	650lm/m	198lm/ft
Cutting Length	50mm 1.97"			
IP Grade	IP67			

Note: 'x' (CCT) = *27*(2700K) / *30*(3000K) / *40*(4000K) / *50*(5000K) / *60*(6000K), Please contact us for more information.

Dimension

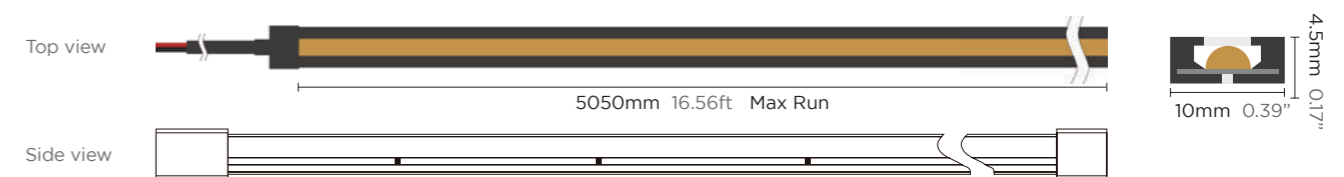

Accessories

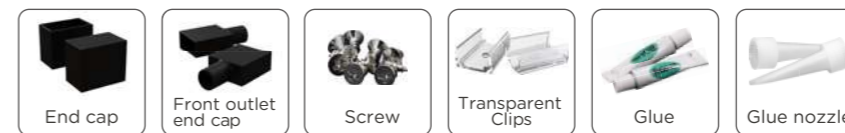

* Please contact our sales for the latest details and certifications

COB Connectors

Single Color

Series	Product			PCB Width	Product NO.
	BB PCB to PCB	XB Cable to PCB	BXB PCB to Cable to PCB		
LD- COB H Series Maximum voltage: 36V Maximum current: 5A				8mm	COB2P-C08BB-G1 COB2P-C08XB-G1 COB2P-C08MBXB-G1
				10mm	COB2P-C10BB-G1 COB2P-C10XB-G1 COB2P-C10MBXB-G1
LD- COB E Series Maximum voltage: 36V Maximum current: 5A				8mm	COB2P-C08BB-G1 COB2P-C08XB-G1 COB2P-C08MBXB-G1
				10mm	COB2P-C10BB-G1 COB2P-C10XB-G1 COB2P-C10MBXB-G1

Tunable

Series	Product			PCB Width	Product NO.
	BB PCB to PCB	XB Cable to PCB	BXB PCB to Cable to PCB		
LD- COB H Series Maximum voltage: 36V Maximum current: 5A				8mm	COB3/4P-C10BB-G1 COB3P-C10XB-G1 COB3P-C10MBXB-G1
				10mm	COB2P-C10BB-G1 COB2P-C10XB-G1 COB2P-C10MBXB-G1

RGB

Series	Product			PCB Width	Product NO.
	BB PCB to PCB	XB Cable to PCB	BXB PCB to Cable to PCB		
LD- COB H Series Maximum voltage: 36V Maximum current: 5A				10mm	COB3/4P-C10BB-G1 COB4P-C10XB-G1 COB4P-C10MBXB-G1
LD- COB E Series Maximum voltage: 36V Maximum current: 5A			/	10mm	COB4P-C10BB SMD4P-C10BB COB4P-C10XB

COB IP Rating

<p>IP20 Ribbon Series</p>	
<p>IP65 Hollow Extrusion</p>	
<p>NEON IP67</p>	
<p>IP68 Jade series</p>	

FLEXIBLE WALL WASHER SERIES

Module Wall washer

3D Wall washer

Rainbow Wall washer

Spotless wall washer

Mini wall washer



Module Wall washer

30x21mm

White / RGBW/ 36W / 24V



1 Module 1 Cutting,
Washing height up to 7m.
UV resistant PC lens, IP67 for outdoor application.
Designed for unconventional space,
not just appearance, more creativity and feasibility.

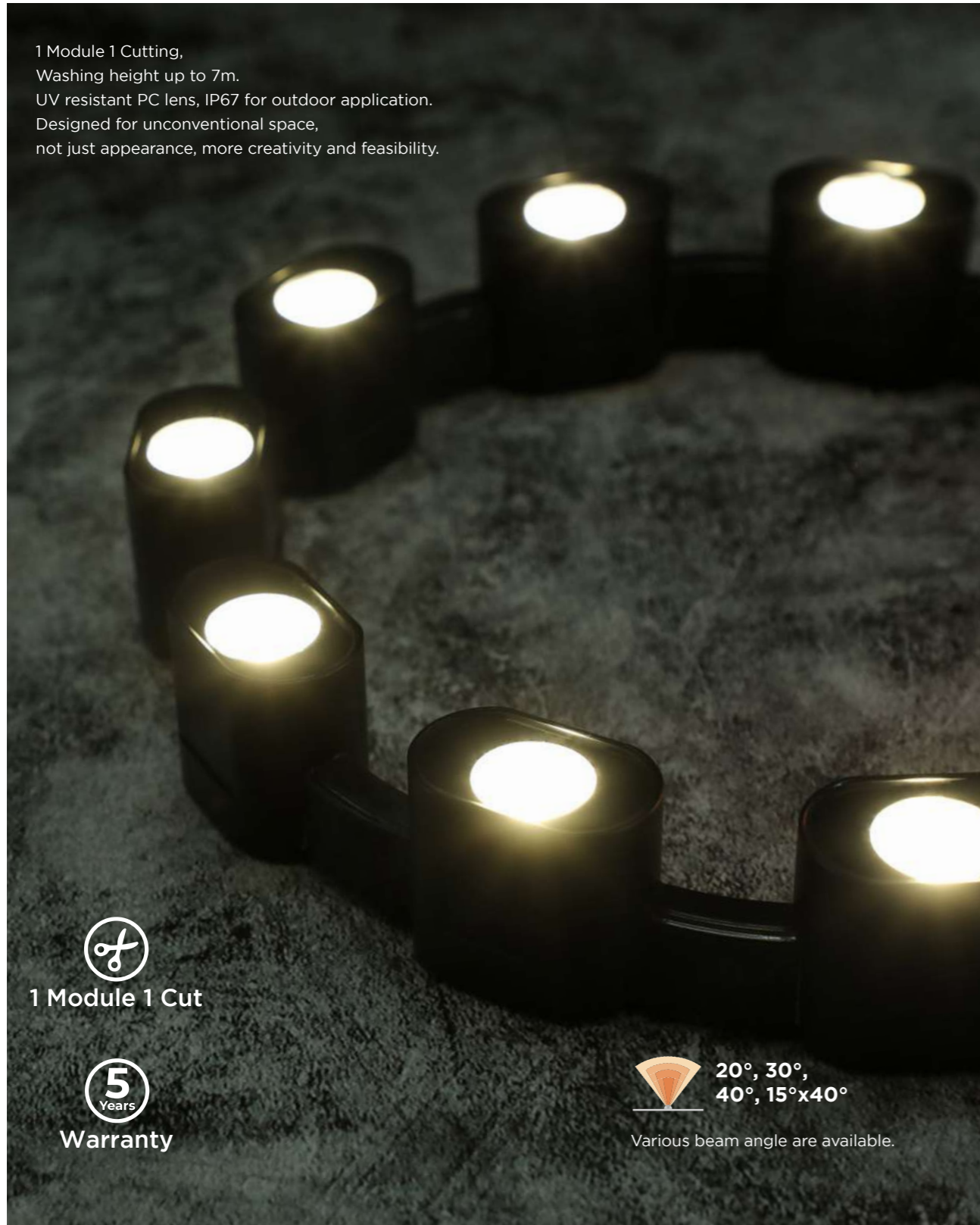

FLEXIBLE WALL WASHER · MODULE WALL WASHER

 1 Module 1 Cut

 5 Years Warranty

 20°, 30°, 40°, 15°x40°
Various beam angle are available.



White / Side bending

Product NO.
FHW36WS-P7-G1 30YL8x 24V20S1 3021L02D40 Dx

RGBW Side bending

Product NO.
FHW36DS-P7-G1 35TXRGB8x 24VD20S 3021L2D40 Dx

Parameter	White / Side bending				RGBW Side bending			
Voltage	DC24V				DC24V			
Power	36W/M 10.97W/ft				36W/M 10.97W/ft			
CRI	80 (3030LEDs)				80 (3535LEDs)			
Led Qty	20LEDs/M 6LEDs/ft				20LEDs/M 6LEDs/ft			
Cutting Length	300mm 11.8"				300mm 11.8"			
IP Grade	IP67				IP67			
Length/Reel	2.4m 7.87ft				2.4m 7.87ft			
Lumens	20°	30°	40°	15x40°	20°	30°	40°	15x40°
● 2700K	2235lm/m 681lm/ft	2270lm/m 692lm/ft	2055lm/m 627lm/ft	1945lm/m 593lm/ft	● R 155lm/m 47lm/ft	170lm/m 51lm/ft	153lm/m 46lm/ft	120lm/m 36lm/ft
● 3000K	2630lm/m 802lm/ft	2670lm/m 814lm/ft	2420lm/m 738lm/ft	2280lm/m 695lm/ft	● G 335lm/m 102lm/ft	365lm/m 112lm/ft	330lm/m 101lm/ft	250lm/m 76lm/ft
● 4000K	3060lm/m 933lm/ft	3140lm/m 957lm/ft	2850lm/m 869lm/ft	2520lm/m 768lm/ft	● B 100lm/m 30lm/ft	110lm/m 34lm/ft	100lm/m 30lm/ft	75lm/m 23lm/ft
○ 5000K	3060lm/m 933lm/ft	3140lm/m 957lm/ft	2850lm/m 869lm/ft	2520lm/m 768lm/ft	○ White 270lm/m 82lm/ft	295lm/m 90lm/ft	270lm/m 82lm/ft	205lm/m 62lm/ft

Note: 'x' (CCT) = "27"(2700K) / "30"(3000K) / "40"(4000K) / "50"(5000K) / "60"(6000K), Please contact us for more information.

Dimension

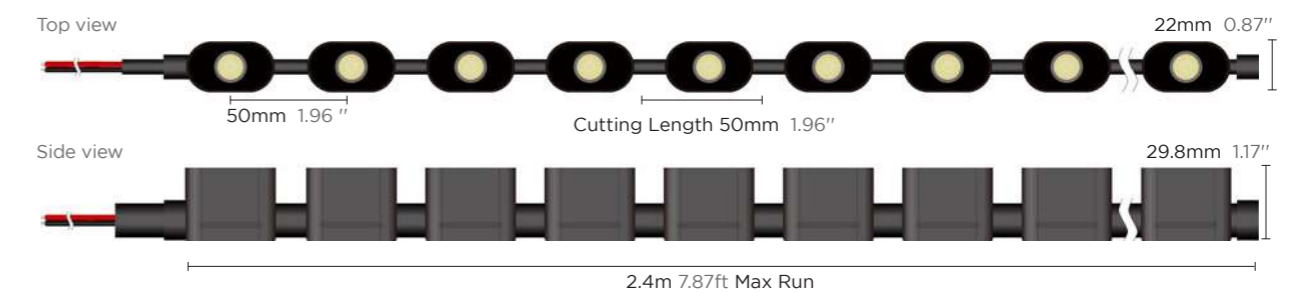

* Please contact our sales for the latest details and certifications

FLEXIBLE WALL WASHER · MODULE WALL WASHER

3D Wall washer

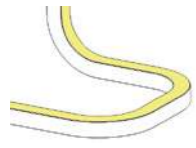

24x18mm
CCT / 24W / 24V

3D bending and top lighting,
Free cutting, 1 LED 1 cutting.
IP67 and Easy installation.
Min top bending diameter 100mm, Min side bending diameter 300mm.
Beam angles of 20°, 30°, 40°, 15°x 40° are available.



Correct bending way

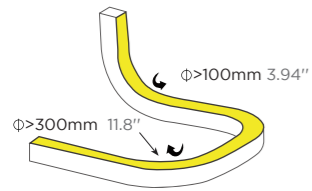

CCT 3D Bending

Product NO.
FHW26WTS-P7-G1 30YL9x 24V24S1 2418L05 Dx

Technical Details

Voltage	DC24V			
Power	26W/M 7.93W/ft			
CRI	90 (3030LEDs)			
Led Qty	24LEDs/M 7LEDs/ft			
Cutting Length	41.67mm 1.64"			
IP Grade	IP67			
Length/Reel	5020mm 16.46ft			
Lumens	20°	30°	40°	15x40°
● 2700K	1820lm/m 555lm/ft	1845 lm/m 565lm/ft	1665lm/m 510lm/ft	1560lm/m 475lm/ft
● 3000K	1845lm/m 560lm/ft	1870 lm/m 570lm/ft	1715lm/m 520lm/ft	1610lm/m 490lm/ft
● 4000K	2155lm/m 657lm/ft	2210lm/m 675lm/ft	2025lm/m 617lm/ft	1790lm/m 545lm/ft
● 5000K	2155lm/m 657lm/ft	2210lm/m 675lm/ft	2025lm/m 617lm/ft	1790lm/m 545lm/ft

Note: 'x' (CCT) = "27"(2700K) / "30"(3000K) / "40"(4000K) / "50"(5000K) / "60"(6000K), Please contact us for more information.

Dimension



* Please contact our sales for the latest details and certifications

Rainbow Wall washer



24x18mm RGB Top Bending / RGBW Top Bending 24W / 24V

Min top bending 30 cm.
Beam angles of 20°, 30°, 40°, 15°x 40° are available.



Correct bending way

Top bending

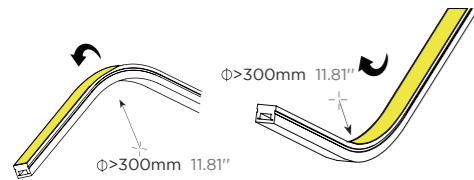

RGB Top bending



RGBW Top bending

Technical Details Product NO. FHW24C-P7-G1 35TXRGB 24V24S 2418L05 Dx

Technical Details Product NO. FHW24C-P7-G1 35TXRGBx 24V24S 2418L05 Dx

Voltage	DC24V
Power	24W/M 7.31W/ft
CRI	- (3535LEDs)
Led Qty	24LEDs/M 7LEDs/ft
Cutting Length	250mm 9.84"
IP Grade	IP67
Length/Reel	5020mm 16.46ft

Voltage	DC24V
Power	24W/M 7.31W/ft
CRI	80 (3535LEDs)
Led Qty	24LEDs/M 7LEDs/ft
Cutting Length	250mm 9.84"
IP Grade	IP67
Length/Reel	5020mm 16.46ft

Lumens	20°	30°	40°	15x40°
R	400lm/m 122lm/ft	410lm/m 125lm/ft	375lm/m 114lm/ft	355lm/m 108lm/ft
G	765lm/m 233lm/ft	755lm/m 239lm/ft	715lm/m 218lm/ft	640lm/m 195lm/ft
B	190lm/m 58lm/ft	195lm/m 59lm/ft	180lm/m 55lm/ft	160lm/m 49lm/ft

Lumens	20°	30°	40°	15x40°
R	250lm/m 76lm/ft	255lm/m 78lm/ft	230lm/m 70lm/ft	210lm/m 64lm/ft
G	590lm/m 180lm/ft	600lm/m 183lm/ft	545lm/m 166lm/ft	490lm/m 149lm/ft
B	170lm/m 52lm/ft	175lm/m 53lm/ft	160lm/m 49lm/ft	145lm/m 44lm/ft

Lumens	White	3000K	40°	15x40°
White	455m/m 139lm/ft	460m/m 140lm/ft	420m/m 128lm/ft	380m/m 116lm/ft

Note: 'x' (CCT) = "27"(2700K) / "30"(3000K) / "40"(4000K) / "50"(5000K) / "60"(6000K), Please contact us for more information.

Dimension



* Please contact our sales for the latest details and certifications

FLEXIBLE WALL WASHER · 24X18MM TOP BENDING

FLEXIBLE WALL WASHER · 24X18MM TOP BENDING

Spotless wall washer

24x20mm / 60*100°
White

Top bending and top emitting product.
Uniform illumination, better cost-effectiveness.
IP65 and salt-mist proof, L70B50 > 50,000hrs Min.



Correct bending way

Top bending

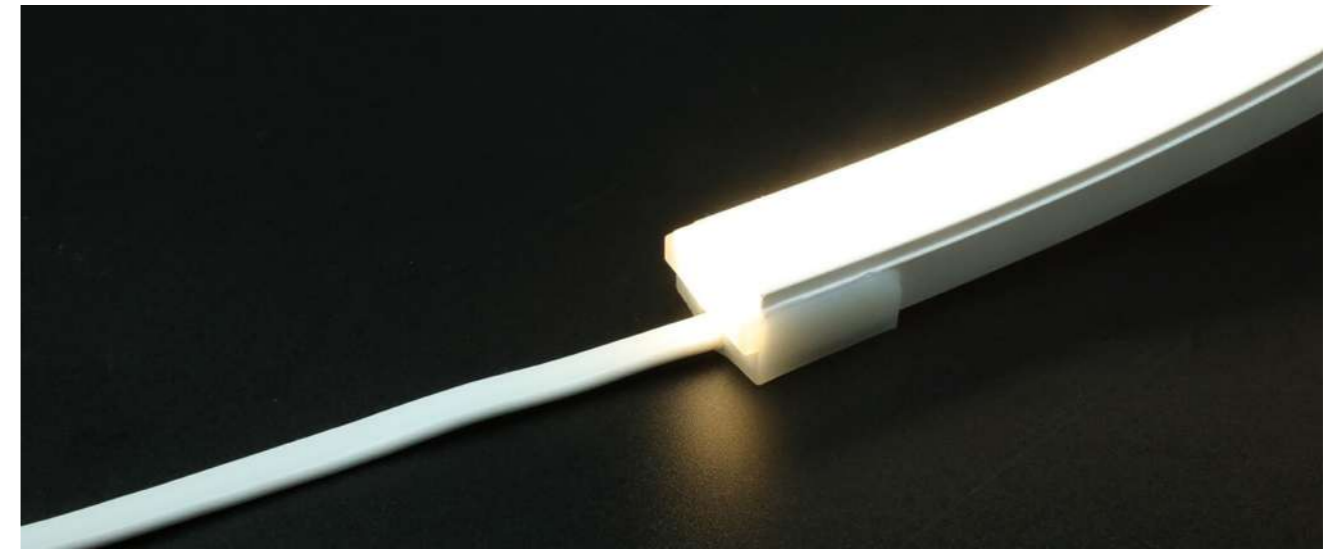
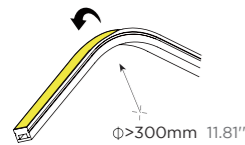

2700K 3000K 4000K 6000K

24x20mm 19W

Technical Details **Product NO.** FEW19W-P5-G1 28HZ9x 24V60S 2420L05 D60x100

Voltage	DC24V	
Power	19.2W/M 5.85W/ft	
CRI	90 (2835LEDs)	
Led Qty	60LEDs/M 18LEDs/ft	
Cutting Length	100mm 3.93"	
IP Grade	IP65	
Length/Reel	5020mm 16.46ft	
Lumens	60x100°	
● 2700K	1535lm/m	468lm/ft
● 3000K	1575lm/m	480lm/ft
● 4000K	1700lm/m	518lm/ft
○ 6000K	1700lm/m	518lm/ft

Note: 'x' (CCT) = *27*(2700K) / *30*(3000K) / *40*(4000K) / *50*(5000K) / *60*(6000K), Please contact us for more information.

Dimension

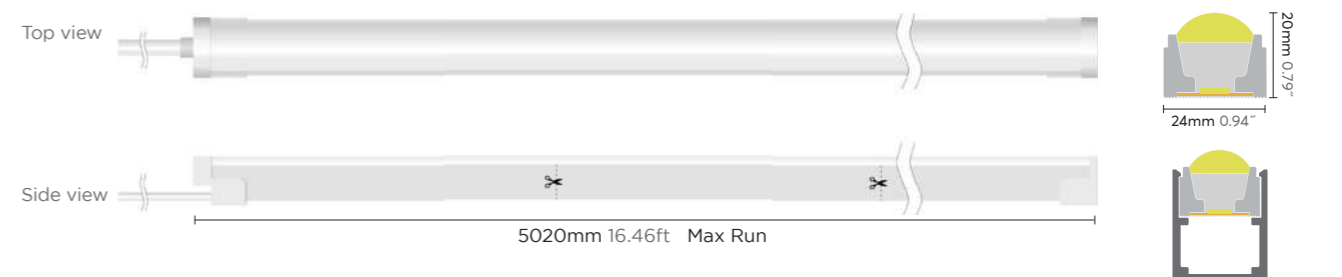

* Please contact our sales for the latest details and certifications



10x7mm Mini wall washer



White

Product NO.
FEW14W-P2-G1 28LD9x 24V56S 1007L05 D30

Power	14.4W/M 4.39W/ft
Voltage	DC24V
CRI	90 (2835LEDs)
Led Qty	56LEDs/M 17LEDs/ft
Length/Reel	5020mm 16.46ft
Cutting Length	125mm 4.92" / 7LEDs Group
IP Grade	IP62
Lumens	<ul style="list-style-type: none"> ● 2200K 1150lm/m 351lm/ft ● 2700K 1350lm/m 411lm/ft ● 3000K 1440lm/m 439lm/ft ● 4000K 1520lm/m 463lm/ft ● 5000K 1450lm/m 442lm/ft ● 6000K 1440lm/m 439lm/ft

Tunable CCT

Product NO.
FEW19C-P2-G1 28LD92765 24V56S 1007L05 D30

Power	19.2W/M 5.85W/ft
Voltage	DC24V
CRI	90 (2835LEDs)
Led Qty	56LEDs/M 17LEDs/ft
Length/Reel	5020mm 16.46ft
Cutting Length	125mm 4.92" / 7LEDs Group
IP Grade	IP62
Lumens	<ul style="list-style-type: none"> ● 2700K 860lm/m 262lm/ft ● 6500K 960lm/m 293lm/ft

Note: 'x' (CCT) = "27"(2700K) / "30"(3000K) / "40"(4000K) / "50"(5000K) / "60"(6000K), Please contact us for more information.

Dimension





12x8mm Mini wall washer

2835 SMD

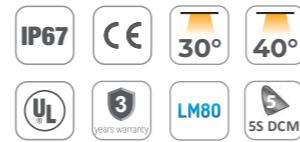

2700K-5000K

White 56LEDs/M 14W 30°

Product NO. FEW14W-P7-G1 28LD9x 24V56S7 1208L05 D30 ErP

Technical Details	White 56LEDs/M 14W 30°	RGB 56LEDs/M 14W 40°
Power	14.4W/M 4.39W/ft	14.4W/M 4.39W/ft
Voltage	DC24V	DC24V
CRI	90 (2835LEDs)	/ (2835LEDs)
Led Qty	56LEDs/M 17LEDs/ft	56LEDs/M 17LEDs/ft
Length/Reel	5020mm 16.46ft	5020mm 16.46ft
Cutting Length	125mm 4.92" / 6LEDs Group	125mm 4.92" / 6LEDs Group
IP Grade	IP67	IP67
Lumens	<ul style="list-style-type: none"> 2700K 1190lm/m 362lm/ft 3000K 1260lm/m 387lm/ft 4000K 1344lm/m 409lm/ft 5000K 1288lm/m 392lm/ft 	<ul style="list-style-type: none"> R Red 130lm/m 39lm/ft G Green 375lm/m 114lm/ft B Blue 75lm/m 23lm/ft

Note: 'x' (CCT) = "27"(2700K) / "30"(3000K) / "40"(4000K) / "50"(5000K) / "60"(6000K), Please contact us for more information.

Dimension



Accessories



* Please contact our sales for the latest details and certifications

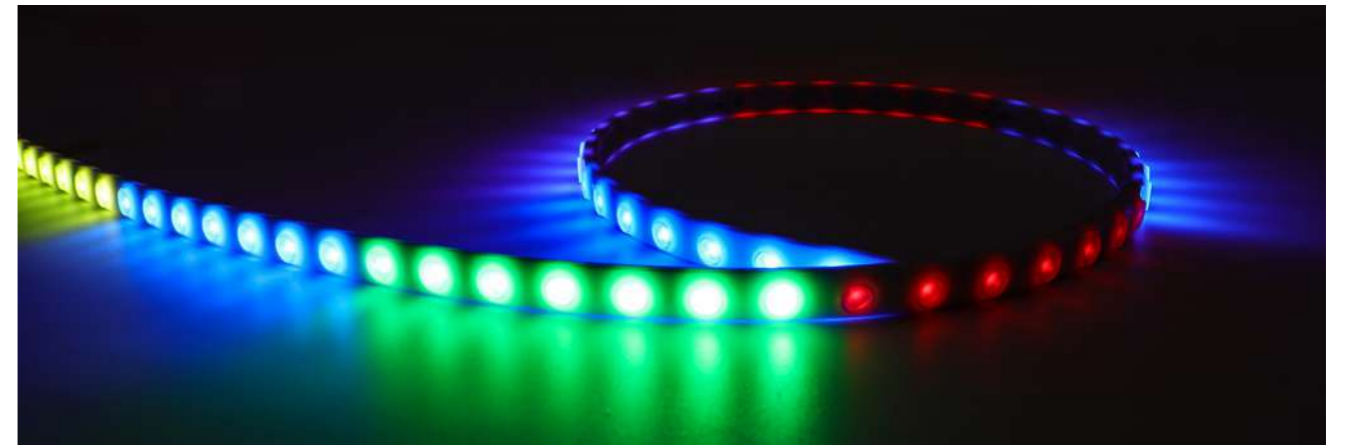

12x8mm Mini wall washer

2835 SMD



DMX RGB 56LEDs/M 14W 40°

Technical Details Product NO. FEW14D-P7-G1 28LDRGB 24VD56S7 1208L05 D40

Technical Details	DMX RGB 56LEDs/M 14W 40°
Power	14.4W/M 4.39W/ft
Voltage	DC24V
CRI	/ (2835LEDs)
Led Qty	56LEDs/M 17LEDs/ft
Length/Reel	5020mm 16.46ft
Cutting Length	125mm 4.92" / 6LEDs Group
IP Grade	IP67
Lumens	<ul style="list-style-type: none"> R Red 80lm/m 24lm/ft G Green 270lm/m 82lm/ft B Blue 60lm/m 18lm/ft

Note: 'x' (CCT) = "27"(2700K) / "30"(3000K) / "40"(4000K) / "50"(5000K) / "60"(6000K), Please contact us for more information.

Dimension

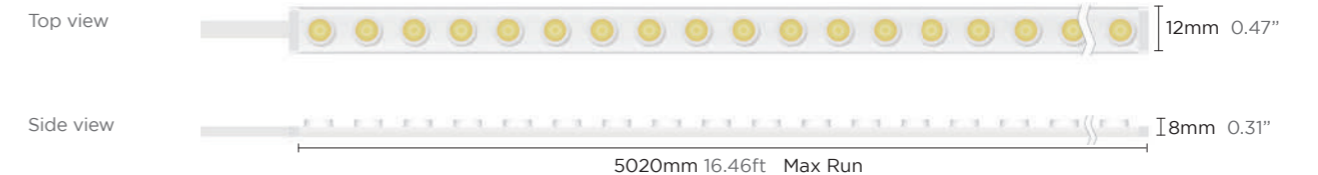

Accessories

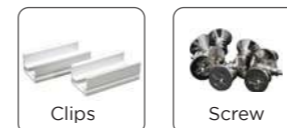

* Please contact our sales for the latest details and certifications



20x10mm Mini wall washer

3030 SMD



24LEDs/M 18W 24V 15°, 30°, 45°, 60°, 25x45°, 25x45x10°

Product NO. FEW18W-P7-G1 30LD8X 24V24S3 2010L05 DX ErP

Technical Details

Power	Voltage	CRI	Led Qty	Length/Reel	Cutting Length	IP Grade
18W/M 5.49W/ft	DC24V	80	24LEDs/M 7LEDs/ft	5020mm 16.46ft	125mm/ 3LEDs Group 4.92" / 3LEDs Group	IP67

Lumens	15°	30°	45°	60°	25x45°
● 2700K	1680lm/m 512lm/ft	1660lm/m 506lm/ft	1640lm/m 500lm/ft	1620lm/m 493lm/ft	1580lm/m 481lm/ft
● 3000K	1780lm/m 542lm/ft	1760lm/m 536lm/ft	1740lm/m 530lm/ft	1720lm/m 524lm/ft	1740lm/m 530lm/ft
● 4000K	1800lm/m 548lm/ft	1800lm/m 548lm/ft	1780lm/m 542lm/ft	1760lm/m 536lm/ft	1780lm/m 542lm/ft
● 5000K	1840lm/m 560lm/ft	1840lm/m 560lm/ft	1820lm/m 554lm/ft	1800lm/m 548lm/ft	1820lm/m 554lm/ft

Note: 'x' (CCT) = *27*(2700K) / *30*(3000K) / *40*(4000K) / *50*(5000K) / *60*(6000K). Please contact us for more information.

Dimension



Accessories



* Please contact our sales for the latest details and certifications



20x10mm Mini wall washer

5050 SMD/RGB/RGBW



28LEDS/M 19W 24V
30°, 60°, 25*45°

28LEDS/M 24W 24V
30°, 60°, 25*45°

FEW19C-P7-G1 50LDRGB 24V28S7 2010L05 Dx

FEW24C-P7-G1 50LDRGBW 24V28S7 2010L05 Dx

Power	19.2W/M 5.85W/ft	24W/M 7.31W/ft
Power	19.2W/M 5.85W/ft	24W/M 7.31W/ft
Voltage	DC24V	DC24V
CRI	/ (5050LEDs)	/ (5050LEDs)
Led Qty	28LEDs/M 8LEDs/ft	28LEDs/M 8LEDs/ft
Length/Reel	5020mm 16.46ft	5020mm 16.46ft
Cutting Length	250mm 9.84" / 7LEDs Group	250mm 9.84" / 7LEDs Group
IP Grade	IP67	IP67
Lumens	R 168lm/m 51lm/ft G 432lm/m 131lm/ft B 78lm/m 23lm/ft	R 168lm/m 51lm/ft G 432lm/m 131lm/ft B 78lm/m 23lm/ft W 570lm/m 173lm/ft

Note: 'x' (CCT) = "27"(2700K) / "30"(3000K) / "40"(4000K) / "50"(5000K) / "60"(6000K), Please contact us for more information.

Dimension

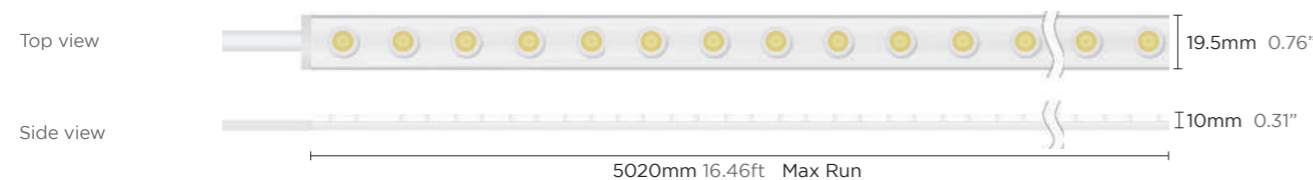

Accessories



* Please contact our sales for the latest details and certifications



20x10mm Mini wall washer

3030 SMD/Single white Digital DMX control



Technical Details FEW18D-P7-G1 30LD8x 24VD24S3 2010L05 Dx

Power	Voltage	CRI	Led Qty	Length/Reel	Cutting Length	IP Grade
18W/M 5.49W/ft	DC24V	80 (3030LEDs)	24LEDs/m 7LEDs/ft	5020mm 16.46ft	125mm/ 3LED Group 4.92" / 3LED Group	IP67
Lumens	15°	30°	45°	60°	25x45°	
● 2700K	1590lm/m 484lm/ft	1570lm/m 478lm/ft	1500lm/m 457lm/ft	1480lm/m 451lm/ft	1500lm/m 457lm/ft	
● 3000K	1690lm/m 515lm/ft	1670lm/m 509lm/ft	1650lm/m 503lm/ft	1630lm/m 496lm/ft	1650lm/m 503lm/ft	
● 4000K	1730lm/m 527lm/ft	1710lm/m 521lm/ft	1690lm/m 515lm/ft	1670lm/m 509lm/ft	1690lm/m 515lm/ft	
● 5000K	1760lm/m 536lm/ft	1750lm/m 533lm/ft	1730lm/m 527lm/ft	1710lm/m 521lm/ft	1730lm/m 527lm/ft	

Note: 'x' (CCT) = "27"(2700K) / "30"(3000K) / "40"(4000K) / "50"(5000K) / "60"(6000K), Please contact us for more information.

Dimension

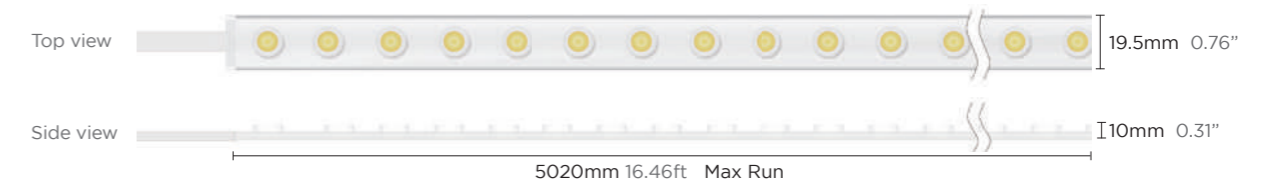

Accessories



* Please contact our sales for the latest details and certifications

LED STRIP SERIES

Honor series (24V / 12V)

2835 / 5050

Essential series (24V / 12V)

2835 / 3528 / 5050

ErP series

Energy saving series

Spotless series

2835 Reel to reel series

Ultra-long series

24V / 48V / 110-220V

Mini led series

2110 / 2216 Plus

DTW LED strip series

Constant current resistor-free LED strip

Sauna room LED strip

Swimming pool LED strip

A single strip optional three power

Cabinet LEDstrip (24V / 12V)

Multi-row strip

CRI 95/98

Colorful series



Honor Series

High CRI, CRI>90;
High luminous efficiency, which up to 100lm/w;
High color consistency, SDCM<5, optional for SDCM<3

Honor Series

2835 Low Power 12V/24V



IP Grade

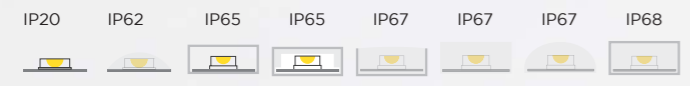

Dimension

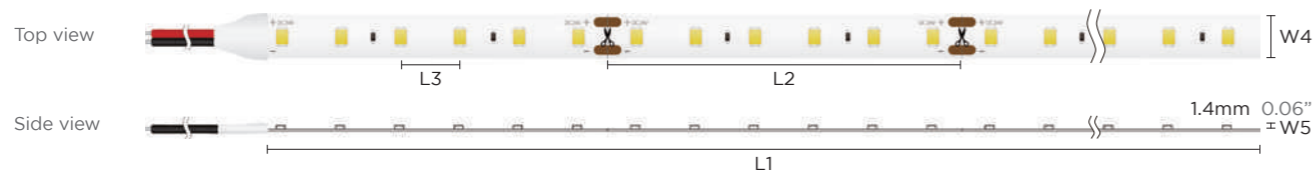

	L1	L2	L3	W4
FH05W-PO-G1 28LZ9x 24V60S W08L05	5m 16.41ft	100mm 3.94"	16.7mm 0.66"	8mm 0.31"
FH08W-PO-G1 28LZ9x 24V96S W08L05	5m 16.41ft	62.5mm 2.46"	10.4mm 0.41"	8mm 0.31"
FH10W-PO-G1 28LZ9x 24V120S W08L05	5m 16.41ft	50mm 1.97"	8.3mm 0.33"	8mm 0.31"
FH14W-PO-G1 28LZ9x 24V180S W10L05	5m 16.41ft	33.3mm 1.31"	5.6mm 0.22"	10mm 0.39"
FH19W-PO-G1 28LZ9x 24V240S W10L05	5m 16.41ft	25mm 0.98"	4.2mm 0.17"	10mm 0.39"

Technical Details	60LEDs/M 5W 24V/12V	96LEDs/M 8W
	FH05W-PO-G1 28LZ9X 24V60S W08L05	FH08W-PO-G1 28LZ9X 24V96S W08L05
Power	4.8W/M 1.46W/ft	7.6W/M 2.32W/ft
Voltage	DC24V / DC12V	DC24V
CRI	90	90
Led Qty	60LEDs/M 18LEDs/ft	96LEDs/M 29LEDs/ft
Length/Reel	5M 16.41ft	5M 16.41ft
IP Grade	IP20/IP62/IP65/IP67/IP68	IP20/IP62/IP65/IP67/IP68

Technical Details	120LEDs/M 10W 24V/12V	180LEDs/M 14W
	FH10W-PO-G1 28LZ9X 24V120S W08L05	FH14W-PO-G1 28LZ9X 24V180S W10L05
Power	9.6W/M 2.93W/ft	14.4W/M 4.39W/ft
Voltage	DC24V / DC12V	DC24V
CRI	90	90
Led Qty	120LEDs/M 36LEDs/ft	180LEDs/M 54LEDs/ft
Length/Reel	5M 16.41ft	5M 16.41ft
IP Grade	IP20/IP62/IP65/IP67/IP68	IP20/IP62/IP65/IP67/IP68

Technical Details	240LEDs/M 19W
	FH19W-PO-G1 28LZ9X 24V240S W10L05
Power	19.2W/M 5.85W/ft
Voltage	DC24V
CRI	90
Led Qty	240LEDs/M 73LEDs/ft
Length/Reel	5M 16.41ft
IP Grade	IP20/IP62/IP65/IP67/IP68

	60LEDs/M	96LEDs/M	120LEDs/M	180LEDs/M	240LEDs/M
● 2200K	385lm/m 117lm/ft	610lm/m 186lm/ft	770lm/m 235lm/ft	1150lm/m 351lm/ft	1535lm/m 468lm/ft
● 2400K	410lm/m 125lm/ft	645lm/m 197lm/ft	820lm/m 250lm/ft	1220lm/m 372lm/ft	1630lm/m 497lm/ft
● 2700K	455lm/m 139lm/ft	720lm/m 220lm/ft	910lm/m 277lm/ft	1370lm/m 418lm/ft	1820lm/m 555lm/ft
● 3000K	480lm/m 146lm/ft	760lm/m 232lm/ft	960lm/m 293lm/ft	1440lm/m 439lm/ft	1920lm/m 585lm/ft
● 4000K	490lm/m 149lm/ft	775lm/m 236lm/ft	980lm/m 299lm/ft	1470lm/m 448lm/ft	1960lm/m 598lm/ft
● 5000K	490lm/m 149lm/ft	775lm/m 236lm/ft	980lm/m 299lm/ft	1470lm/m 448lm/ft	1960lm/m 598lm/ft
● 6500K	490lm/m 149lm/ft	775lm/m 236lm/ft	980lm/m 299lm/ft	1470lm/m 448lm/ft	1960lm/m 598lm/ft

Note: 'x' (CCT) = "27"(2700K) / "30"(3000K) / "40"(4000K) / "50"(5000K) / "60"(6000K), Please contact us for more information.

* Please contact our sales for the latest details and certifications

Connectors List

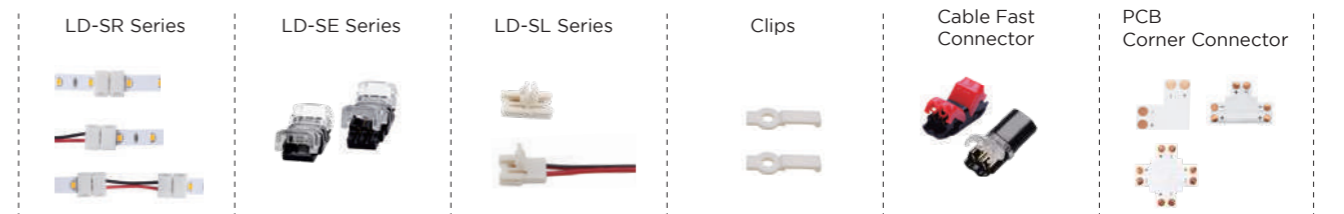

* Please Go to page 248 for Accessory and Connector Usage Guidelines.

Honor Series

2835 Regular Power 12V/24V

High CRI, CRI>90;
High luminous efficiency, which up to 100lm/w;
High color consistency, SDCM<5, optional for SDCM<3



IP Grade

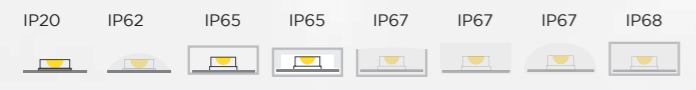

Connectors List

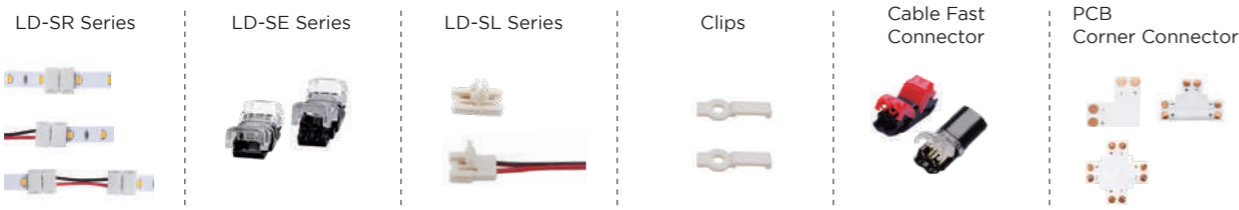

* Please Go to page 248 for Accessory and Connector Usage Guidelines.

Technical Details	30LEDs/M 8W	60LEDs/M 10W 24V/12V
	FH09W-PO-G1 28HZ9X 24V30S W08L05	FH10W-PO-G1 28HZ9X 24V60S W08L05
Power	8.5W/M 2.59W/ft	10W/M 3.05W/ft
Voltage	DC24V	DC24V / DC12V
CRI	90	90
Led Qty	30LEDs/M 9LEDs/ft	60LEDs/M 18LEDs/ft
Length/Reel	5M 16.41ft	5M 16.41ft
IP Grade	IP20/IP62/IP65/IP67/IP68	IP20/IP62/IP65/IP67/IP68

Technical Details	60LEDs/M 14W 24V/12V	120LEDs/M 19W 24V/12V
	FH14W-PO-G1 28HZ9X 24V60S W10L05	FH19W-PO-G1 28HZ9X 24V120S W10L05
Power	14.4W/M 4.39W/ft	19.2W/M 5.85W/ft
Voltage	DC24V / DC12V	DC24V / DC12V
CRI	90	90
Led Qty	60LEDs/M 18LEDs/ft	120LEDs/M 36LEDs/ft
Length/Reel	5M 16.41ft	5M 16.41ft
IP Grade	IP20/IP62/IP65/IP67/IP68	IP20/IP62/IP65/IP67/IP68

Lumens	30LEDs/M		60LEDs/M		60LEDs/M		120LEDs/M	
● 2200K	550lm/m	168lm/ft	780lm/m	238lm/ft	1000lm/m	305lm/ft	1550lm/m	473lm/ft
● 2400K	600lm/m	183lm/ft	870lm/m	265lm/ft	1060lm/m	323lm/ft	1730lm/m	527lm/ft
● 2700K	660lm/m	201lm/ft	910lm/m	277lm/ft	1180lm/m	360lm/ft	1800lm/m	549lm/ft
● 3000K	680lm/m	207lm/ft	950lm/m	290lm/ft	1210lm/m	369lm/ft	1870lm/m	570lm/ft
● 4000K	720lm/m	220lm/ft	1000lm/m	305lm/ft	1350lm/m	412lm/ft	1970lm/m	601lm/ft
● 5000K	720lm/m	220lm/ft	1000lm/m	305lm/ft	1350lm/m	412lm/ft	1970lm/m	601lm/ft
● 6500K	700lm/m	213lm/ft	990lm/m	302lm/ft	1320lm/m	402lm/ft	1920lm/m	585lm/ft

Note: 'x' (CCT) = "27"(2700K) / "30"(3000K) / "40"(4000K) / "50"(5000K) / "60"(6000K), Please contact us for more information.

* Please contact our sales for the latest details and certifications

Dimension



	L1	L2	L3	W4
FH09W-PO-G1 28HZ9X 24V30S W08L05	5m 16.41ft	166.7mm 6.56"	33.3mm 1.31"	8mm 0.31"
FH10W-PO-G1 28HZ9X 24V60S W08L05	5m 16.41ft	100mm 3.94"	16.7mm 0.66"	8mm 0.31"
FH14W-PO-G1 28HZ9X 24V60S W10L05	5m 16.41ft	100mm 3.94"	16.7mm 0.66"	10mm 0.39"
FH19W-PO-G1 28HZ9X 24V120S W10L05	5m 16.41ft	50mm 1.97"	8.3mm 0.33"	10mm 0.39"

Honor Series

2835 Mini Cut 12V/24V

Mini cut unit down to 8.33mm.
12V / 24V voltage for option.
Different color temperature are available.



LED STRIP SERIES · HONOR SERIES



Technical Details	60LEDs/M 12V/24V	120LEDs/M 12V/24V
	FH07W-P0-G1 28AH9X 24V60S1 W08L05	FH10W-P0-G1 28AH9x 24V120S1 W08L05
Power	7.2W/M 2.19W/ft	10W/M 3.05W/ft
Voltage	DC24V / DC12V	DC24V / DC12V
CRI	90	90
Led Qty	60LEDs/M 18LEDs/ft	120LEDs/M 36LEDs/ft
Length/Reel	5M 16.41ft	5M 16.41ft
IP Grade	IP20	IP20
Lumens	60LEDs	120LEDs
● 2700K	580lm/m 177lm/ft	750lm/m 229lm/ft
● 3000K	650lm/m 198lm/ft	820lm/m 250lm/ft
● 4000K	700lm/m 213lm/ft	900lm/m 274lm/ft
● 5000K	680lm/m 207lm/ft	860lm/m 262lm/ft
● 6000K	670lm/m 204lm/ft	850lm/m 259lm/ft

Note: 'x' (CCT) = "27"(2700K) / "30"(3000K) / "40"(4000K) / "50"(5000K) / "60"(6000K), Please contact us for more information.
* Please contact our sales for the latest details and certifications

Dimension

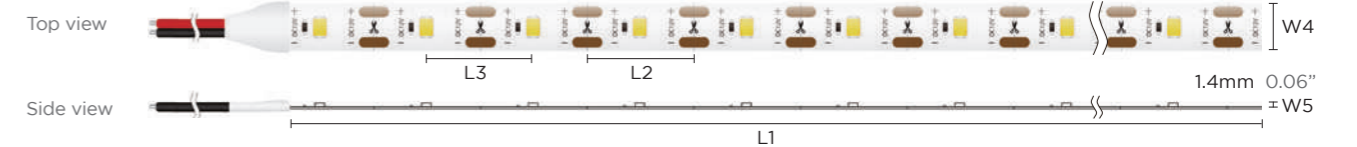

	L1	L2	L3	W4
FH07W-P0-G1 28AH9X 24V60S1 W08L05	5m 16.41ft	16.7mm 0.65"	16.7mm 0.65"	8mm 0.31"
FH10W-P0-G1 28AH9x 24V120S1 W08L05	5m 16.41ft	8.3mm 0.32"	8.3mm 0.32"	8mm 0.31"

Connectors List

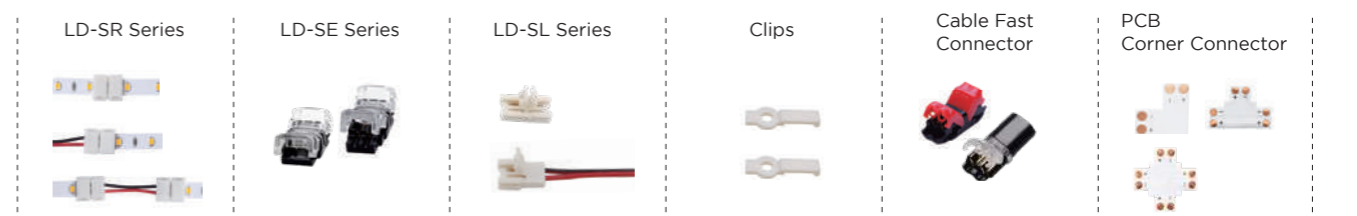

* Please Go to page 248 for Accessory and Connector Usage Guidelines.

LED STRIP SERIES · HONOR SERIES

Honor Series

5050 12V/24V

High CRI; CRI>90.
High efficiency, Up to 100lm/w.
High color consistency, within 5 steps SDCM(3 steps Optional).



IP Grade

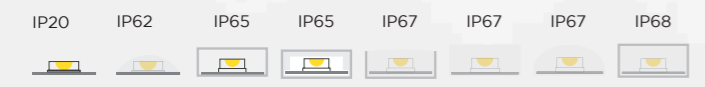

LED STRIP SERIES · HONOR SERIES

Technical Details	30LEDs/M	60LEDs/M
	FH09W-P0-G1 50HZ9X 24V30S W10L05	
Power	8.5W/M 2.59W/ft	14.4W/M 4.39W/ft
Voltage	DC24V/12V	
CRI	90	
Led Qty	30LEDs/M 9LEDs/ft	60LEDs/M 18LEDs/ft
Length/Reel	5M 16.41ft	
IP Grade	IP20/IP62/IP65/IP67/IP68	
Lumens	30LEDs	60LEDs
● 2200K	460lm/m 140lm/ft	930lm/m 284lm/ft
● 2400K	540lm/m 165lm/ft	1080lm/m 329lm/ft
● 2700K	620lm/m 189lm/ft	1260lm/m 384lm/ft
● 3000K	630lm/m 192lm/ft	1280lm/m 390lm/ft
● 4000K	710lm/m 216lm/ft	1410lm/m 430lm/ft
● 5000K	710lm/m 216lm/ft	1410lm/m 430lm/ft
● 6500K	660lm/m 201lm/ft	1320lm/m 402lm/ft

Note: 'x' (CCT) = "27"(2700K) / "30"(3000K) / "40"(4000K) / "50"(5000K) / "60"(6000K), Please contact us for more information.

* Please contact our sales for the latest details and certifications

Dimension DC24V

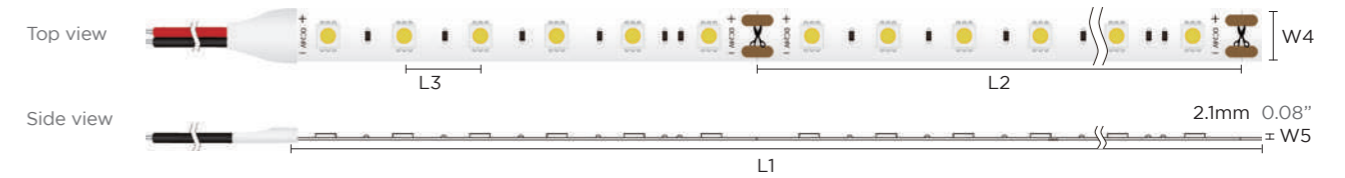

	L1	L2	L3	W4
FH07W-P0-G1 28AH9x 12V60S W08L05	5m 16.41ft	166.7mm 6.56"	33.3mm 1.31"	10mm 0.39"
FH07W-P0-G1 28AH9X 24V60S W08L05	5m 16.41ft	100mm 3.94"	16.7mm 0.66"	10mm 0.39"

Connectors List

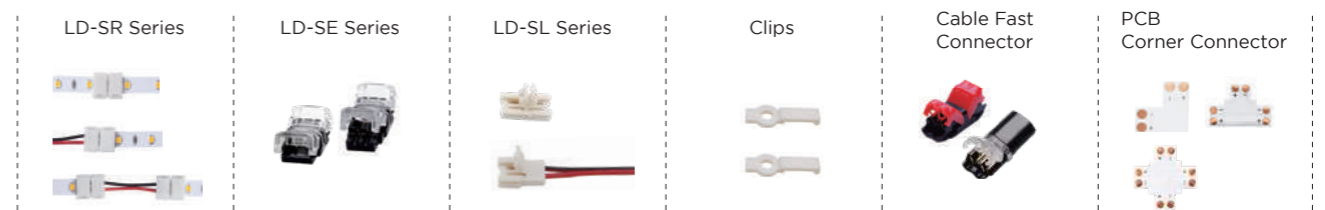

* Please Go to page 248 for Accessory and Connector Usage Guidelines.

LED STRIP SERIES · HONOR SERIES

Honor Series

5050 Mini Cut 12V

Mini cut unit down to 13.89mm.
Different color temperature are available.



LED STRIP SERIES · HONOR SERIES

72LEDs/M 12V

Technical Details FH14W-PO-G1 50HZ9x 12V72S1 W12L01

Power	14.4W/M 4.39W/ft
Voltage	DC12V
CRI	90
Led Qty	72LEDs/M 22LEDs/ft
Length/Reel	1M 3.28ft
IP Grade	IP20

Lumens

2700K	1240lm/m 378lm/ft
3000K	1300lm/m 396lm/ft
4000K	1360lm/m 415lm/ft
5000K	1360lm/m 415lm/ft
6000K	1360lm/m 415lm/ft

Note: 'x' (CCT) = "27"(2700K) / "30"(3000K) / "40"(4000K) / "50"(5000K) / "60"(6000K), Please contact us for more information.

* Please contact our sales for the latest details and certifications

LED STRIP SERIES · HONOR SERIES

Dimension

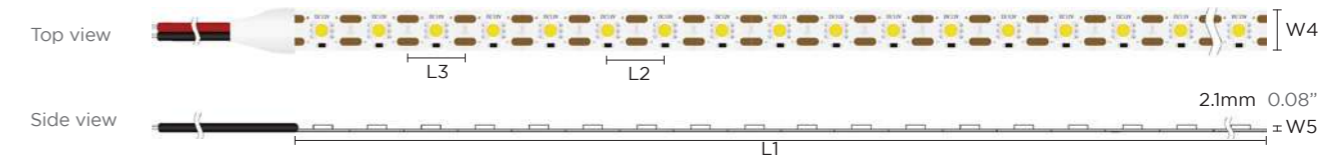

	L1	L2	L3	W4
FH07W-PO-G1 28AH9X 24V60S1 W08L05	1m 3.28ft	13.89mm 0.55"	13.89mm 0.55"	12mm 0.47"

Connectors List

LD-SR Series 	LD-SE Series 	LD-SL Series 	Clips 	Cable Fast Connector 	PCB Corner Connector
-------------------------	-------------------------	-------------------------	------------------	---------------------------------	---------------------------------

* Please Go to page 248 for Accessory and Connector Usage Guidelines.



Essential Series

High CRI, CRI>90;
High luminous efficiency, up to 100lm/w;
High color consistency, SDCM<5, optional for SDCM<3

Essential Series

2835 Low Power

Independent LED packaging, high quality;
High efficiency, up to 100 lm/W;
2200-6000K, Color temperatures are available.



IP Grade

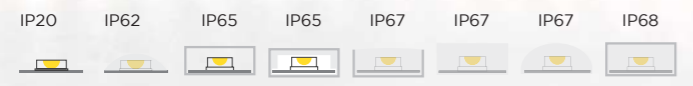

Dimension

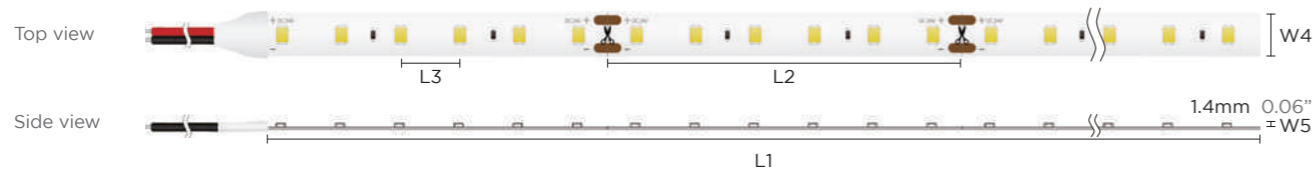

	L1	L2	L3	W4
FE05W-PO-G1 28LX8X 24V60S W08L05	5m 16.41ft	100mm 3.94"	16.7mm 0.66"	8mm 0.31"
FE10W-PO-G1 28LX8X 24V120S W08L05	5m 16.41ft	50mm 1.97"	8.3mm 0.33"	8mm 0.31"
FE14W-PO-G1 28LX8X 24V180S W10L05	5m 16.41ft	33.3mm 1.31"	5.6mm 0.22"	10mm 0.39"
FE19W-PO-G1 28LX8X 24V240S W10L05	5m 16.41ft	25mm 0.98"	4.2mm 0.17"	10mm 0.39"
FE05W-PO-G1 28LX9X 24V60S W08L05	5m 16.41ft	100mm 3.94"	16.7mm 0.66"	8mm 0.31"
FE10W-PO-G1 28LX9X 24V120S W08L05	5m 16.41ft	50mm 1.97"	8.3mm 0.33"	8mm 0.31"
FE14W-PO-G1 28LX9X 24V180S W10L05	5m 16.41ft	33.3mm 1.31"	5.6mm 0.22"	10mm 0.39"
FE19W-PO-G1 28LX9X 24V240S W10L05	5m 16.41ft	25mm 0.98"	4.2mm 0.17"	10mm 0.39"

60LEDs/M

FE05W-PO-G1 28LX8X 24V60S W08L05
FE05W-PO-G1 28LX9X 24V60S W08L05

Power	4.8W/M 1.46W/ft	9.6W/M 2.93W/ft
Voltage	DC24V	DC24V
CRI	80/90	80/90
Led Qty	60LEDs/M 18LEDs/ft	120LEDs/M 36LEDs/ft
Length/Reel	5M 16.41ft	5M 16.41ft
IP Grade	IP20/IP62/IP65/IP67/IP68	IP20/IP62/IP65/IP67/IP68

180LEDs/M

FE14W-PO-G1 28LX8X 24V180S W10L05
FE14W-PO-G1 28LX9X 24V180S W10L05

Power	14.4W/M 4.39W/ft	19.2W/M 5.85W/ft
Voltage	DC24V	DC24V
CRI	80/90	80/90
Led Qty	180LEDs/M 54LEDs/ft	240LEDs/M 73LEDs/ft
Length/Reel	5M 16.41ft	5M 16.41ft
IP Grade	IP20/IP62/IP65/IP67/IP68	IP20/IP62/IP65/IP67/IP68

120LEDs/M

FE10W-PO-G1 28LX8X 24V120S W08L05
FE10W-PO-G1 28LX9X 24V120S W08L05

240LEDs/M

FE19W-PO-G1 28LX8X 24V240S W10L05
FE19W-PO-G1 28LX9X 24V240S W10L05

Lumens	60LEDs		120LEDs		180LEDs		240LEDs	
	CRI80	CRI90	CRI80	CRI90	CRI80	CRI90	CRI80	CRI90
● 2200K	374lm/m 114lm/ft	385lm/m 117lm/ft	749lm/m 228lm/ft	770lm/m 235lm/ft	1123lm/m 342lm/ft	1155lm/m 352lm/ft	1498lm/m 457lm/ft	1540lm/m 470lm/ft
● 2400K	403lm/m 123lm/ft	410lm/m 125lm/ft	806lm/m 246lm/ft	820lm/m 250lm/ft	1210lm/m 369lm/ft	1230lm/m 375lm/ft	1613lm/m 492lm/ft	1640lm/m 500lm/ft
● 2700K	451lm/m 138lm/ft	455lm/m 139lm/ft	902lm/m 275lm/ft	910lm/m 277lm/ft	1354lm/m 413lm/ft	1365lm/m 416lm/ft	1805lm/m 550lm/ft	1820lm/m 555lm/ft
● 3000K	466lm/m 142lm/ft	475lm/m 145lm/ft	931lm/m 284lm/ft	950lm/m 290lm/ft	1397lm/m 426lm/ft	1365lm/m 416lm/ft	1862lm/m 568lm/ft	1900lm/m 579lm/ft
● 4000K	509lm/m 155lm/ft	480lm/m 146lm/ft	1018lm/m 310lm/ft	960lm/m 293lm/ft	1526lm/m 465lm/ft	1400lm/m 427lm/ft	2035lm/m 620lm/ft	1920lm/m 585lm/ft
● 5000K	490lm/m 149lm/ft	480lm/m 146lm/ft	979lm/m 298lm/ft	960lm/m 293lm/ft	1469lm/m 448lm/ft	1400lm/m 427lm/ft	1958lm/m 597lm/ft	1920lm/m 585lm/ft
● 6500K	480lm/m 146lm/ft	480lm/m 146lm/ft	960lm/m 293lm/ft	960lm/m 293lm/ft	1440lm/m 439lm/ft	1400lm/m 427lm/ft	1920lm/m 585lm/ft	1920lm/m 585lm/ft

* Please contact our sales for the latest details and certifications

Note: "x" (CCT) = "27"(2700K) / "30"(3000K) / "40"(4000K) / "50"(5000K) / "60"(6000K), Please contact us for more information.

Connectors List

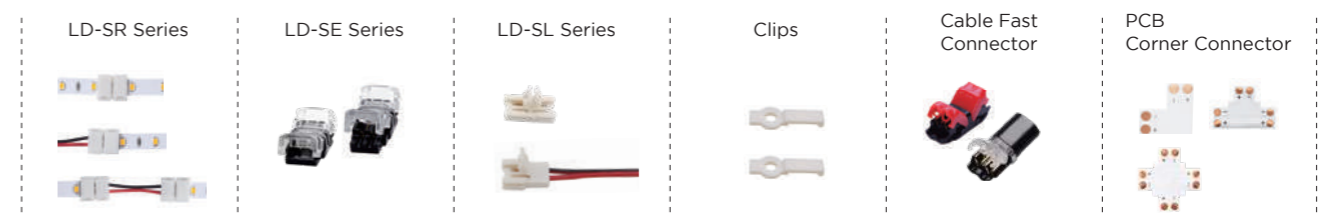

* Please Go to page 248 for Accessory and Connector Usage Guidelines.

Essential Series

2835 Regular Power



IP Grade

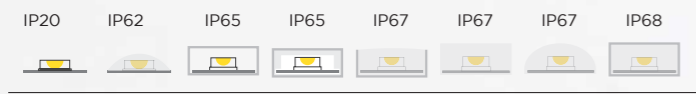

Dimension

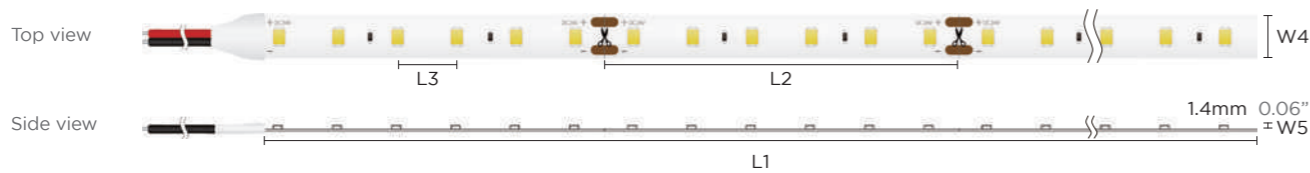

	L1	L2	L3	W4
FE10W-PO-G1 28HX8X 24V60S W08L05	5m 16.41ft	100mm 3.94"	16.7mm 0.66"	8mm 0.31"
FE14W-PO-G1 28HX8X 24V60S W10L05	5m 16.41ft	100mm 3.94"	16.7mm 0.66"	10mm 0.39"
FE19W-PO-G1 28HX8X 24V120S W10L05	5m 16.41ft	50mm 1.97"	8.3mm 0.33"	10mm 0.39"
FE10W-PO-G1 28HX9X 24V60S W08L05	5m 16.41ft	100mm 3.94"	16.7mm 0.66"	8mm 0.31"
FE14W-PO-G1 28HX9X 24V60S W10L05	5m 16.41ft	100mm 3.94"	16.7mm 0.66"	10mm 0.39"
FE19W-PO-G1 28HX9X 24V120S W10L05	5m 16.41ft	50mm 1.97"	8.3mm 0.33"	10mm 0.39"

60LEDs/M 10W CRI80

FE10W-PO-G1 28HX8X 24V60S W08L05

Power	10W/M 3.05W/ft
Voltage	DC24V
CRI	80
Led Qty	60LEDs/M 18LEDs/ft
Length/Reel	5M 16.41ft
IP Grade	IP20/IP62/IP65/IP67/IP68

60LEDs/M 10W CRI90

FE10W-PO-G1 28HX9X 24V60S W08L05

Power	10W/M 3.05W/ft
Voltage	DC24V
CRI	90
Led Qty	60LEDs/M 18LEDs/ft
Length/Reel	5M 16.41ft
IP Grade	IP20/IP62/IP65/IP67/IP68

60LEDs/M 14.4W CRI80

FE14W-PO-G1 28HX8X 24V60S W10L05

Power	14.4W/M 4.39W/ft
Voltage	DC24V
CRI	80
Led Qty	60LEDs/M 18LEDs/ft
Length/Reel	5M 16.41ft
IP Grade	IP20/IP62/IP65/IP67/IP68

60LEDs/M 14.4W CRI90

FE14W-PO-G1 28HX9X 24V60S W10L05

Power	14.4W/M 4.39W/ft
Voltage	DC24V
CRI	90
Led Qty	60LEDs/M 18LEDs/ft
Length/Reel	5M 16.41ft
IP Grade	IP20/IP62/IP65/IP67/IP68

120LEDs/M 19.2W CRI80

FE19W-PO-G1 28HX8X 24V120S W10L05

Power	19.2W/M 5.85W/ft
Voltage	DC24V
CRI	80
Led Qty	120LEDs/M 36LEDs/ft
Length/Reel	5M 16.41ft
IP Grade	IP20/IP62/IP65/IP67/IP68

120LEDs/M 19.2W CRI90

FE19W-PO-G1 28HX9X 24V120S W10L05

Power	19.2W/M 5.85W/ft
Voltage	DC24V
CRI	90
Led Qty	120LEDs/M 36LEDs/ft
Length/Reel	5M 16.41ft
IP Grade	IP20/IP62/IP65/IP67/IP68

Power	10W 60LEDs		14.4W 60LEDs		19.2W 120LEDs	
	CRI80	CRI90	CRI80	CRI90	CRI80	CRI90
2200K	780lm/m 238lm/ft	750lm/m 229lm/ft	1123lm/m 342lm/ft	1050lm/m 320lm/ft	1498lm/m 457lm/ft	1440lm/m 439lm/ft
2400K	840lm/m 256lm/ft	800lm/m 244lm/ft	1210lm/m 369lm/ft	1120lm/m 341lm/ft	1613lm/m 492lm/ft	1535lm/m 468lm/ft
2700K	940lm/m 287lm/ft	900lm/m 274lm/ft	1354lm/m 413lm/ft	1250lm/m 381lm/ft	1805lm/m 550lm/ft	1730lm/m 527lm/ft
3000K	970lm/m 296lm/ft	950lm/m 290lm/ft	1397lm/m 426lm/ft	1325lm/m 404lm/ft	1862lm/m 568lm/ft	1820lm/m 555lm/ft
4000K	1060lm/m 323lm/ft	980lm/m 299lm/ft	1526lm/m 465lm/ft	1370lm/m 418lm/ft	2035lm/m 620lm/ft	1880lm/m 573lm/ft
5000K	1020lm/m 311lm/ft	980lm/m 299lm/ft	1469lm/m 448lm/ft	1370lm/m 418lm/ft	1958lm/m 597lm/ft	1880lm/m 573lm/ft
6500K	1000lm/m 305lm/ft	980lm/m 299lm/ft	1440lm/m 439lm/ft	1370lm/m 418lm/ft	1920lm/m 585lm/ft	1880lm/m 573lm/ft

Note: 'x' (CCT) = "27"(2700K) / "30"(3000K) / "40"(4000K) / "50"(5000K) / "60"(6000K), Please contact us for more information.

* Please contact our sales for the latest details and certifications

Connectors List

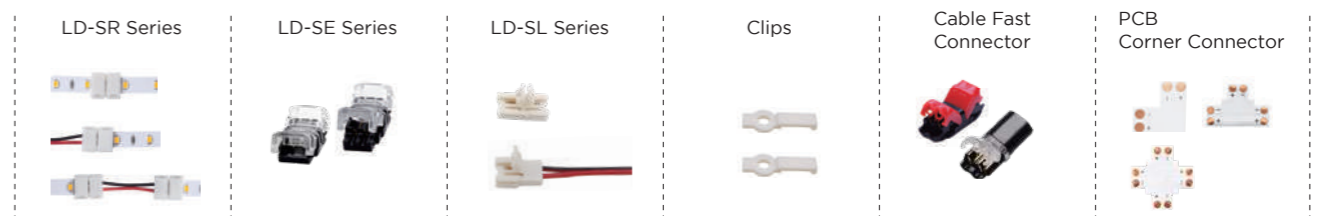

* Please Go to page 248 for Accessory and Connector Usage Guidelines.

Essential Series

3528 12V/24V

High CRI; CRI>95.
High Efficiency, Up to 100lm/w.
High color consistency, within 5 steps SDCM(3 steps Optional).

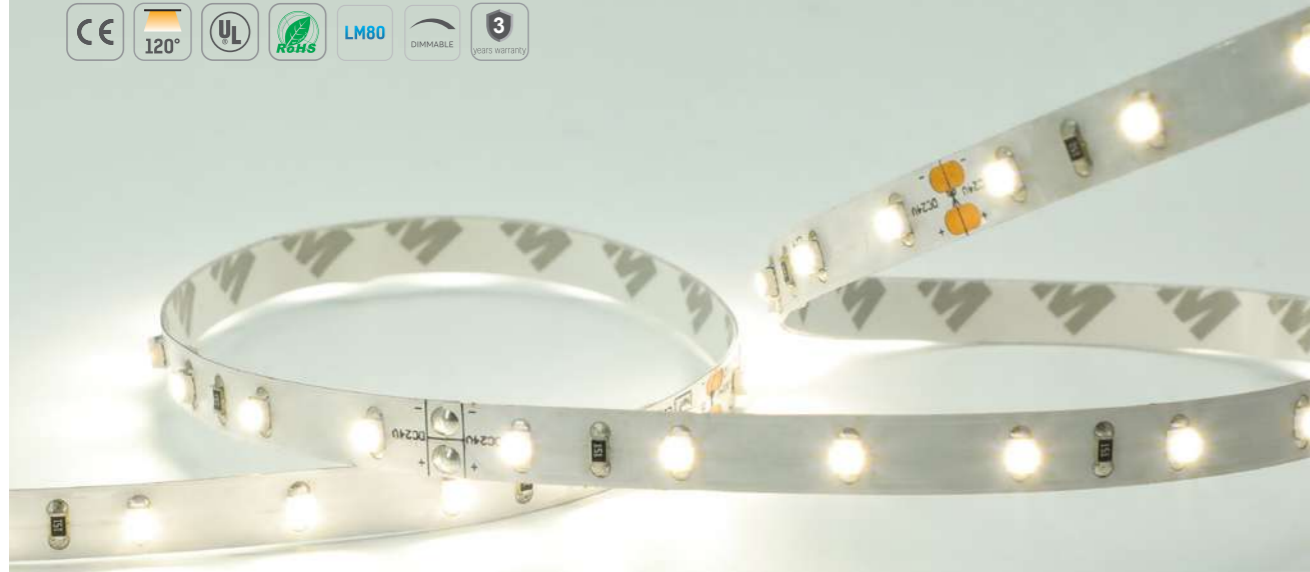

IP Grade

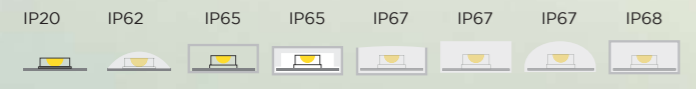

Connectors List

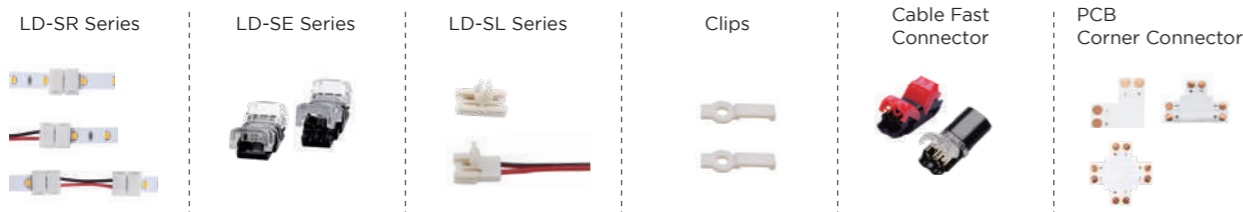

* Please Go to page 248 for Accessory and Connector Usage Guidelines.

LED STRIP SERIES · ESSENTIAL SERIES

LED STRIP SERIES · ESSENTIAL SERIES

Technical Details	30LEDs/M	60LEDs/M
	FH02W-PO-G1 35ZSFx 24V30S5 W08L05	FH05W-PO-G1 35ZSFx 24V60S W08L05
Power	2.4W/M 0.73W/ft	4.8W/M 1.46W/ft
Voltage	DC24V / DC12V	DC24V / DC12V
CRI	95	95
Led Qty	30LEDs/M 9LEDs/ft	60LEDs/M 18LEDs/ft
Cutting Length	166.6mm 6.56" / 100mm 3.94"	100mm 3.94" / 50mm 1.97"
Length/Reel	5M 16.41ft	5M 16.41ft
IP Grade	IP20/IP62/IP65/IP67/IP68	IP20/IP62/IP65/IP67/IP68

Technical Details	120LEDs/M
	FH10W-PO-G1 35ZSFx 24V120S W08L05
Power	9.6W/M 2.93W/ft
Voltage	DC24V / DC12V
CRI	95
Led Qty	120LEDs/M 37LEDs/ft
Cutting Length	50mm 1.97" / 25mm 0.98"
Length/Reel	5M 16.41ft
IP Grade	IP20/IP62/IP65/IP67/IP68

Lumens	30LEDs		60LEDs		60LEDs	
	● 2400K	160lm/m	49lm/ft	330lm/m	101lm/ft	660lm/m
● 2700K	165lm/m	50lm/ft	340lm/m	104lm/ft	680lm/m	207lm/ft
● 3000K	170lm/m	52lm/ft	350lm/m	107lm/ft	700lm/m	213lm/ft
● 4000K	175lm/m	53lm/ft	360lm/m	110lm/ft	720lm/m	220lm/ft
● 5000K	180lm/m	55lm/ft	400lm/m	122lm/ft	800lm/m	244lm/ft
● 6500K	170lm/m	52lm/ft	350lm/m	107lm/ft	700lm/m	213lm/ft

Note: 'x' (CCT) = "27"(2700K) / "30"(3000K) / "40"(4000K) / "50"(5000K) / "60"(6000K), Please contact us for more information.

Dimension



	L1	L2	W3	W4
FH02W-PO-G1 35ZSFx 24V30S5 W08L05	5m 16.41ft	27.77mm 1.09"	8mm 0.32"	2.1mm 0.08"
FH05W-PO-G1 35ZSFx 24V60S W08L05	5m 16.41ft	16.67mm 0.66"	8mm 0.32"	2.1mm 0.08"
FH10W-PO-G1 35ZSFx 24V120S W08L05	5m 16.41ft	8.33mm 0.33"	8mm 0.32"	2.1mm 0.08"
FH02W-PO-G1 35ZSFx 12V30S W08L05	5m 16.41ft	33.33mm 1.31"	8mm 0.32"	2.1mm 0.08"
FH05W-PO-G1 35ZSFx 12V60S W08L05	5m 16.41ft	16.67mm 0.66"	8mm 0.32"	2.1mm 0.08"
FH10W-PO-G1 35ZSFx 12V120S W08L05	5m 16.41ft	8.33mm 0.33"	8mm 0.32"	2.1mm 0.08"

Essential Series

5050

High CRI; CRI>90.
High efficiency, Up to 100lm/w.
High color consistency, within 5 steps SDCM(3 steps Optional).



IP Grade

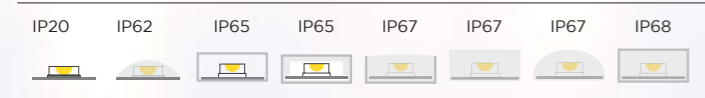

Connectors List



* Please Go to page 248 for Accessory and Connector Usage Guidelines.

Technical Details	30LEDs/M CRI80	30LEDs/M CRI90
	FE06W-PO-G1 50X8X 24V30S W10L05	FE07W-PO-G1 50X9X 24V30S W10L05
Power	6W/M 1.82W/ft	7.2W/M 2.19W/ft
Voltage	DC24V	DC24V
CRI	80	90
Led Qty	30LEDs/M 9LEDs/ft	30LEDs/M 9LEDs/ft
Length/Reel	5M 16.41ft	5M 16.41ft
IP Grade	IP20/IP62/IP65/IP67/IP68	IP20/IP62/IP65/IP67/IP68

Technical Details	60LEDs/M CRI80	60LEDs/M CRI90
	FE12W-PO-G1 50X8X 24V60S W10L05	FE14W-PO-G1 50X9X 24V60S W10L05
Power	12W/M 3.65W/ft	14.4W/M 4.39W/ft
Voltage	DC24V	DC24V
CRI	80	90
Led Qty	60LEDs/M 18LEDs/ft	60LEDs/M 18LEDs/ft
Length/Reel	5M 16.41ft	5M 16.41ft
IP Grade	IP20/IP62/IP65/IP67/IP68	IP20/IP62/IP65/IP67/IP68

Power	6W 30LEDs		7W 30LEDs		12W 60LEDs		14W 60LEDs	
	CRI80		CRI90		CRI80		CRI90	
● 2200K	420lm/m	128lm/ft	440lm/m	134lm/ft	966lm/m	295lm/ft	1015lm/m	309lm/ft
● 2400K	456lm/m	139lm/ft	480lm/m	146lm/ft	1049lm/m	320lm/ft	1100lm/m	335lm/ft
● 2700K	498lm/m	152lm/ft	530lm/m	162lm/ft	1145lm/m	349lm/ft	1200lm/m	366lm/ft
● 3000K	510lm/m	155lm/ft	535lm/m	163lm/ft	1173lm/m	358lm/ft	1230lm/m	375lm/ft
● 4000K	564lm/m	172lm/ft	590lm/m	180lm/ft	1297lm/m	395lm/ft	1360lm/m	415lm/ft
● 5000K	558lm/m	170lm/ft	586lm/m	179lm/ft	1283lm/m	391lm/ft	1350lm/m	412lm/ft
● 6500K	552lm/m	168lm/ft	580lm/m	177lm/ft	1270lm/m	387lm/ft	1330lm/m	405lm/ft

Note: 'x' (CCT) = "27"(2700K) / "30"(3000K) / "40"(4000K) / "50"(5000K) / "60"(6000K), Please contact us for more information.

* Please contact our sales for the latest details and certifications

Dimension

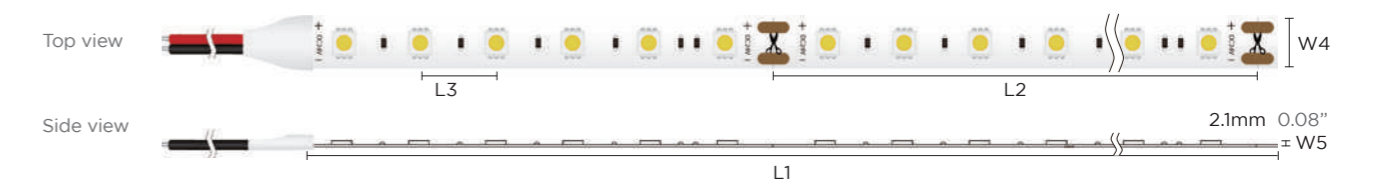

	L1	L2	L3	W4
FE06W-PO-G1 50X8X 24V30S W10L05	5m 16.41ft	166.7mm 6.56"	33.3mm 1.31"	10mm 0.39"
FE07W-PO-G1 50X9X 24V30S W10L05	5m 16.41ft	166.7mm 6.56"	33.3mm 1.31"	10mm 0.39"
FE12W-PO-G1 50X8X 24V60S W10L05	5m 16.41ft	100mm 3.94"	16.7mm 0.66"	10mm 0.39"
FE14W-PO-G1 50X9X 24V60S W10L05	5m 16.41ft	100mm 3.94"	16.7mm 0.66"	10mm 0.39"

ErP Series

Low Voltage Drop
ErP Qualified, Up to Grades B



UP TO 215 LM/W

The high light efficiency and matching of high CRI can better expand the application range of linear illumination. The ultra-high light efficiency makes the linear illumination gradually replace some of the main lighting fields from the traditional auxiliary ambient light field, and with CRI>90 or higher CRI can fully meet the demands for light in the high-end commercial lighting field. From the outline of ceiling design, creating a light environment to the traditional wall washing function, this series can fully meet the needs of linear lighting in different areas of commercial complex buildings. To achieve the ultimate light environment experience.



3/4OZ PCB



RA80+/RA90+



2700K-6000K



High Quality Chips



115-125LM/W CRI80

70LEDs/M 4.8W

Product NO. FH05W-P0-G1 28HX8X 24V70S7 W08L05



Technical Details

Power	4.8W/M 1.46W/ft	Lumens		ErP Class	
Voltage	DC24V	● 2700K	562lm/m 171lm/ft		F
CRI	80	● 3000K	581lm/m 177lm/ft		E
Led Qty	70LEDs/M 21LEDs/ft	● 4000K	600lm/m 183lm/ft		E
Length/Reel	5004mm 16.41ft	● 5000K	590lm/m 180lm/ft		E
Cutting Length	100mm 3.93"	● 6000K	590lm/m 180lm/ft		E
IP Grade	IP20 / IP62 / IP65 / IP68				

Note: 'x' (CCT) = "27"(2700K) / "30"(3000K) / "40"(4000K) / "50"(5000K) / "60"(6000K), Please contact us for more information.

* Please contact our sales for the latest details and certifications

Dimension

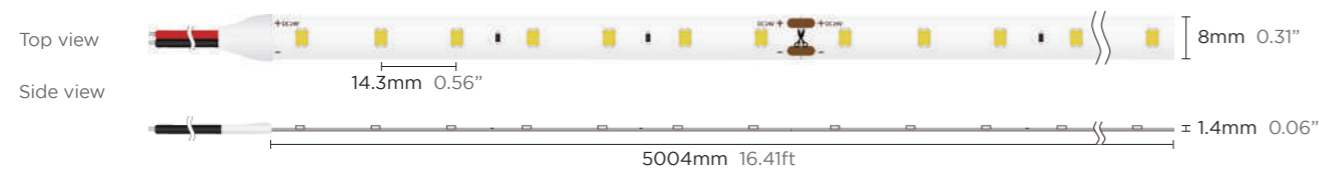

Connectors List

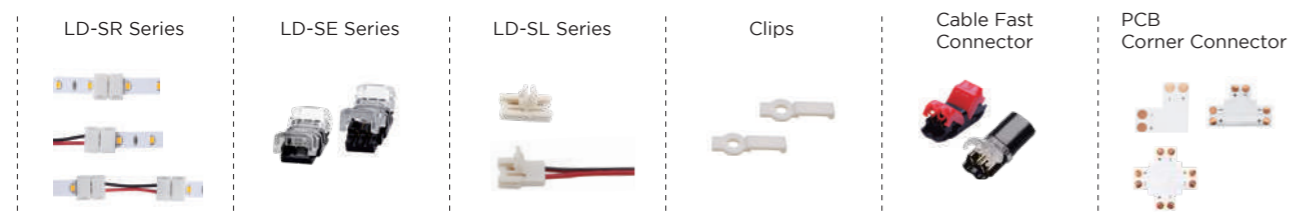

* Please Go to page 248 for Accessory and Connector Usage Guidelines.

115-125LM/W CRI80

140LEDs/M 9.6W

Product NO. FH10W-P0-G1 28HX8X 24V140S7 W08L05



Technical Details

Power	9.6W/M 2.93W/ft	Lumens		ErP Class	
Voltage	DC24V	● 2700K	1123lm/m 342lm/ft		F
CRI	80	● 3000K	1162lm/m 354lm/ft		E
Led Qty	140LEDs/M 42LEDs/ft	● 4000K	1200lm/m 366lm/ft		E
Length/Reel	5004mm 16.41ft	● 5000K	1181lm/m 360lm/ft		E
Cutting Length	50mm 1.97"	● 6000K	1181lm/m 360lm/ft		E
IP Grade	IP20 / IP62 / IP65 / IP68				

Note: 'x' (CCT) = "27"(2700K) / "30"(3000K) / "40"(4000K) / "50"(5000K) / "60"(6000K), Please contact us for more information.

* Please contact our sales for the latest details and certifications

Dimension

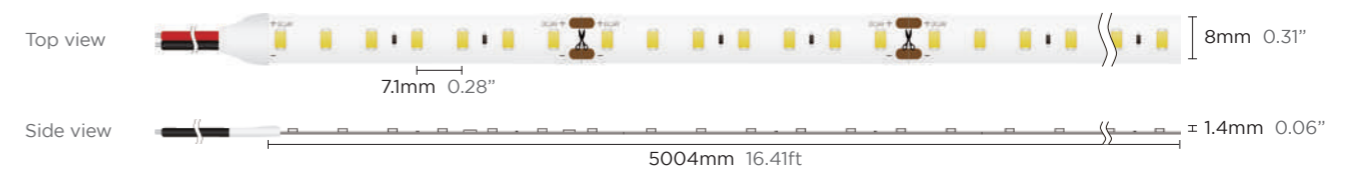

Connectors List



* Please Go to page 248 for Accessory and Connector Usage Guidelines.

115-125LM/W CRI80

210LEDs/M 14.4W

Product NO. FH14W-P0-G1 28HX8X 24V210S7 W10L05



Technical Details

Power	14.4W/M 4.39W/ft	Lumens		ErP Class	
Voltage	DC24V	● 2700K	1685lm/m 514lm/ft	● F	
CRI	80	● 3000K	1742lm/m 531lm/ft	● E	
Led Qty	210LEDs/M 64LEDs/ft	● 4000K	1800lm/m 549lm/ft	● E	
Length/Reel	5004mm 16.41ft	● 5000K	1771lm/m 540lm/ft	● E	
Cutting Length	33.3mm 1.31"	● 6000K	1771lm/m 540lm/ft	● E	
IP Grade	IP20 / IP62 / IP65 / IP68				

Note:'x' (CCT) = "27"(2700K) / "30"(3000K) / "40"(4000K) / "50"(5000K) / "60"(6000K), Please contact us for more information.

* Please contact our sales for the latest details and certifications

Dimension

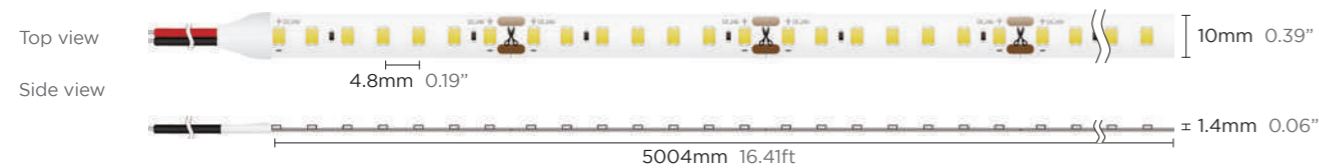

Connectors List

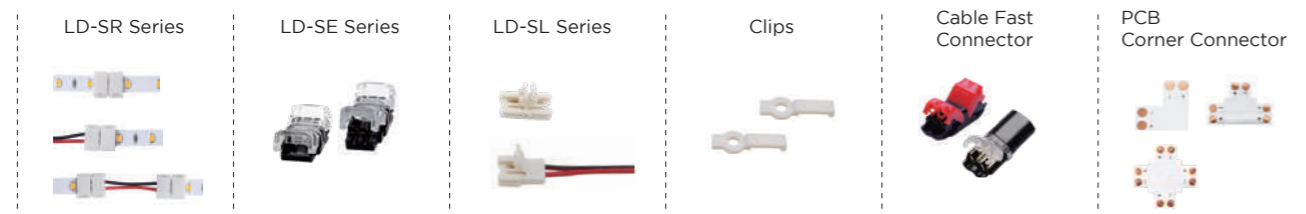

* Please Go to page 248 for Accessory and Connector Usage Guidelines.

115-125LM/W CRI80

252LEDs/M 19.2W

Product NO. FH19W-P0-G1 28HX8X 24V252S7 W10L05

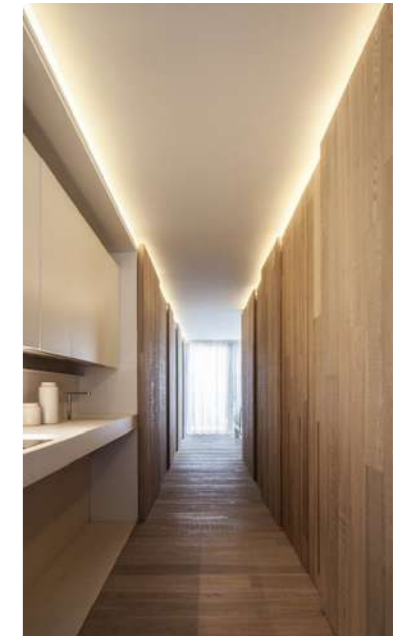

Technical Details

Power	19.2W/M 5.85W/ft	Lumens		ErP Class	
Voltage	DC24V	● 2700K	2205lm/m 672lm/ft	● F	
CRI	80	● 3000K	2300lm/m 701lm/ft	● E	
Led Qty	252LEDs/M 76LEDs/ft	● 4000K	2360lm/m 720lm/ft	● E	
Length/Reel	5004mm 16.41ft	● 5000K	2360lm/m 720lm/ft	● E	
Cutting Length	27.8mm 1.09"	● 6000K	2360lm/m 720lm/ft	● E	
IP Grade	IP20 / IP62 / IP65 / IP68				

Note:'x' (CCT) = "27"(2700K) / "30"(3000K) / "40"(4000K) / "50"(5000K) / "60"(6000K), Please contact us for more information.

* Please contact our sales for the latest details and certifications

Dimension

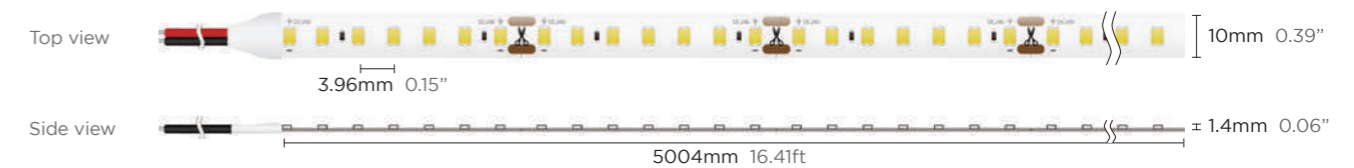

Connectors List

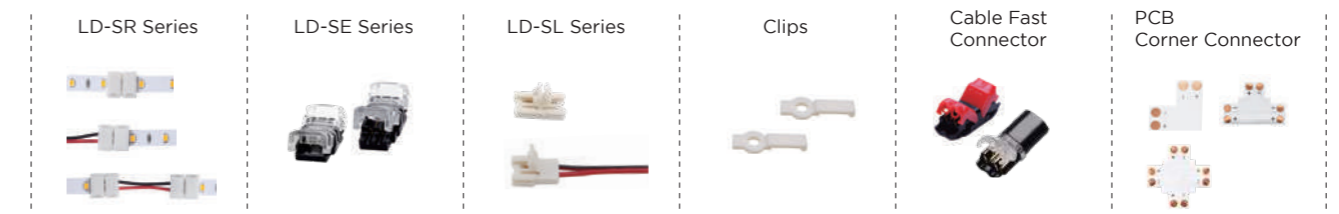

* Please Go to page 248 for Accessory and Connector Usage Guidelines.

130-145LM/W CRI80

64LEDs/M 4.8W

Product NO. FH05W-P0-G1 28HX8X 24V64S8 W08L05



Technical Details

Power	4.8W/M 1.46W/ft	Lumens			ErP Class
Voltage	DC24V	● 2700K	629lm/m	192lm/ft	E
CRI	80	● 3000K	648lm/m	198lm/ft	E
Led Qty	64LEDs/M 19LEDs/ft	● 4000K	696lm/m	212lm/ft	E
Length/Reel	5004mm 16.41ft	● 5000K	677lm/m	206lm/ft	E
Cutting Length	125mm 4.92"	● 6000K	682lm/m	208lm/ft	E
IP Grade	IP20 / IP62 / IP65 / IP68				

Note:'x' (CCT) = "27"(2700K) / "30"(3000K) / "40"(4000K) / "50"(5000K) / "60"(6000K), Please contact us for more information.

* Please contact our sales for the latest details and certifications

Dimension

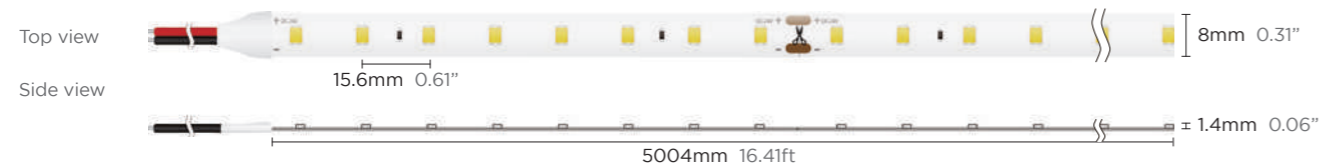

Connectors List

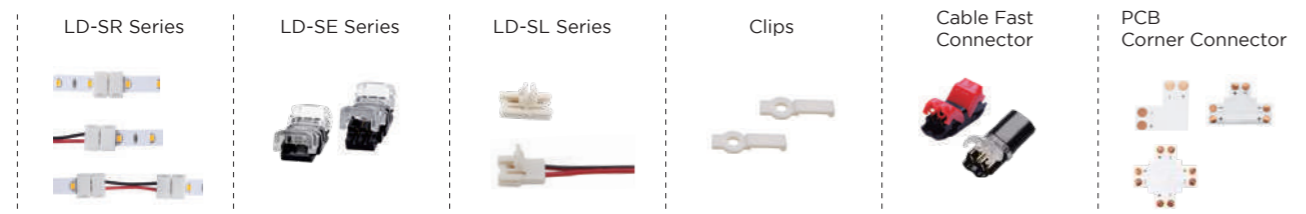

* Please Go to page 248 for Accessory and Connector Usage Guidelines.

130-145LM/W CRI80

80LEDs/M 9.6W

Product NO. FH10W-P0-G1 28HX8X 24V80S8 W08L05



Technical Details

Power	9.6W/M 2.93W/ft	Lumens			ErP Class
Voltage	DC24V	● 2700K	1225lm/m	373lm/ft	E
CRI	80	● 3000K	1250lm/m	381lm/ft	E
Led Qty	80LEDs/M 24LEDs/ft	● 4000K	1300lm/m	396lm/ft	E
Length/Reel	5004mm 16.41ft	● 5000K	1300lm/m	396lm/ft	E
Cutting Length	100mm 3.93"	● 6000K	1300lm/m	396lm/ft	E
IP Grade	IP20 / IP62 / IP65 / IP68				

Note:'x' (CCT) = "27"(2700K) / "30"(3000K) / "40"(4000K) / "50"(5000K) / "60"(6000K), Please contact us for more information.

* Please contact our sales for the latest details and certifications

Dimension

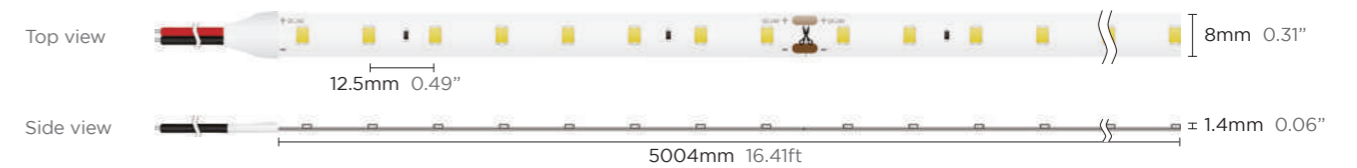

Connectors List



* Please Go to page 248 for Accessory and Connector Usage Guidelines.

130-145LM/W CRI80

128LEDs/M 9.6W

Product NO. FH10W-P0-G1 28HX8X 24V128S8 W10L05



Technical Details

Power	9.6W/M 2.93W/ft	Lumens		ErP Class	
Voltage	DC24V	● 2700K	1258lm/m 384lm/ft	●	E
CRI	80	● 3000K	1296lm/m 395lm/ft	●	E
Led Qty	128LEDs/M 39LEDs/ft	● 4000K	1392lm/m 424lm/ft	●	E
Length/Reel	5004mm 16.41ft	● 5000K	1354lm/m 413lm/ft	●	E
Cutting Length	62.5mm 2.46"	● 6000K	1363lm/m 416lm/ft	●	E
IP Grade	IP20 / IP62 / IP65 / IP68				

Note: 'x' (CCT) = "27"(2700K) / "30"(3000K) / "40"(4000K) / "50"(5000K) / "60"(6000K), Please contact us for more information.

* Please contact our sales for the latest details and certifications

Dimension

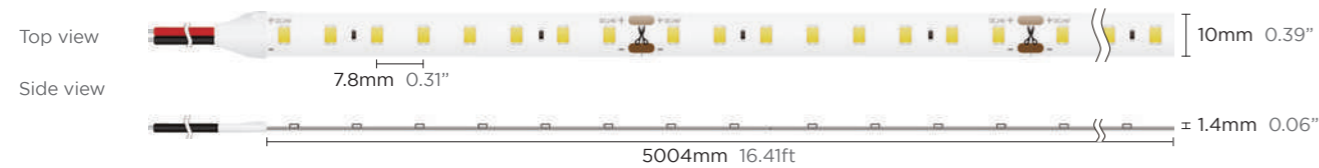

Connectors List

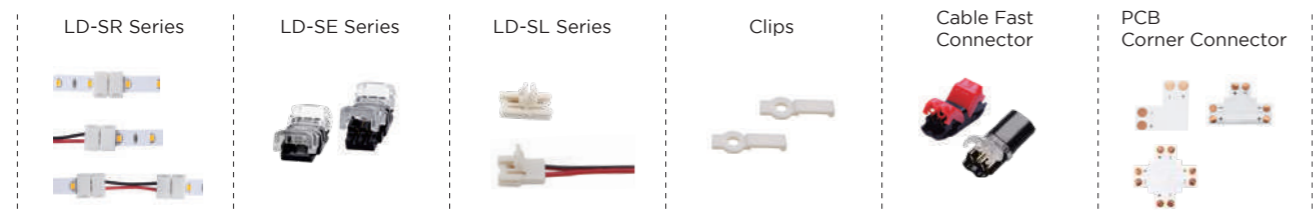

* Please Go to page 248 for Accessory and Connector Usage Guidelines.

130-145LM/W CRI80

160LEDs/M 14.4W

Product NO. FH14W-P0-G1 28HX8X 24V160S8 W10L05



Technical Details

Power	14.4W/M 4.39W/ft	Lumens		ErP Class	
Voltage	DC24V	● 2700K	1885lm/m 575lm/ft	●	E
CRI	80	● 3000K	1945lm/m 593lm/ft	●	E
Led Qty	160LEDs/M 48LEDs/ft	● 4000K	2030lm/m 619lm/ft	●	E
Length/Reel	5004mm 16.41ft	● 5000K	2030lm/m 619lm/ft	●	E
Cutting Length	50mm 1.96"	● 6000K	2030lm/m 619lm/ft	●	E
IP Grade	IP20 / IP62 / IP65 / IP68				

Note: 'x' (CCT) = "27"(2700K) / "30"(3000K) / "40"(4000K) / "50"(5000K) / "60"(6000K), Please contact us for more information.

* Please contact our sales for the latest details and certifications

Dimension



Connectors List

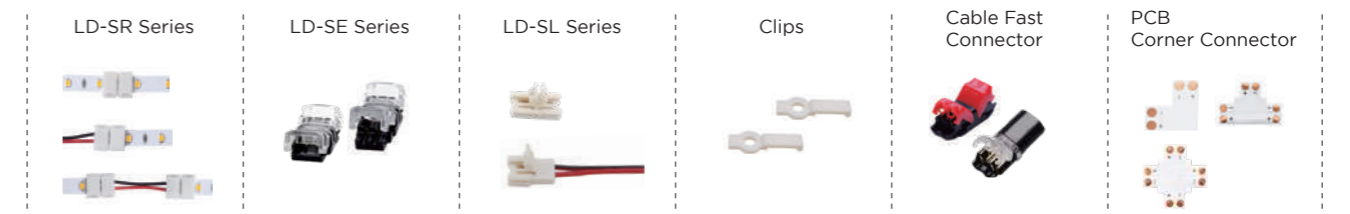

* Please Go to page 248 for Accessory and Connector Usage Guidelines.

165-190LM/W RA80

64LEDs/M 4.8W

Product NO. FH05W-P0-G1 28BL8X 24V64S8 W08L05



Technical Details

Power	4.8W/M 1.46W/ft	Lumens		ErP Class	
Voltage	DC24V	● 2700K	835lm/m 255lm/ft	● 3000K	845lm/m 258lm/ft
RA	80	● 4000K	930lm/m 284lm/ft	● 5000K	930lm/m 284lm/ft
Led Qty	64LEDs/M 19LEDs/ft	● 6000K	920lm/m 280lm/ft		
Length/Reel	5004mm 16.41ft				
Cutting Length	125mm 4.92"				
IP Grade	IP20 / IP62 / IP65 / IP68				

Note: 'x' (CCT) = "27"(2700K) / "30"(3000K) / "40"(4000K) / "50"(5000K) / "60"(6000K), Please contact us for more information.

* Please contact our sales for the latest details and certifications

Dimension

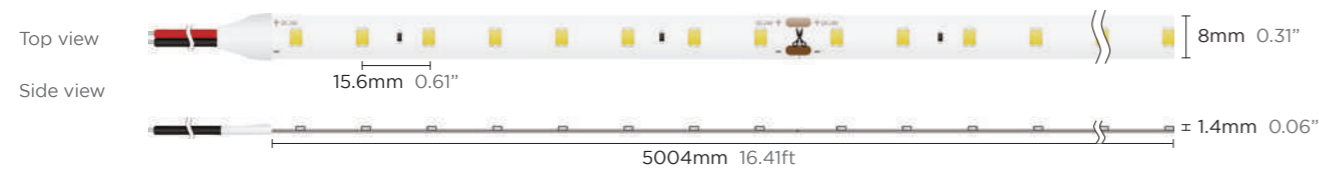

Connectors List

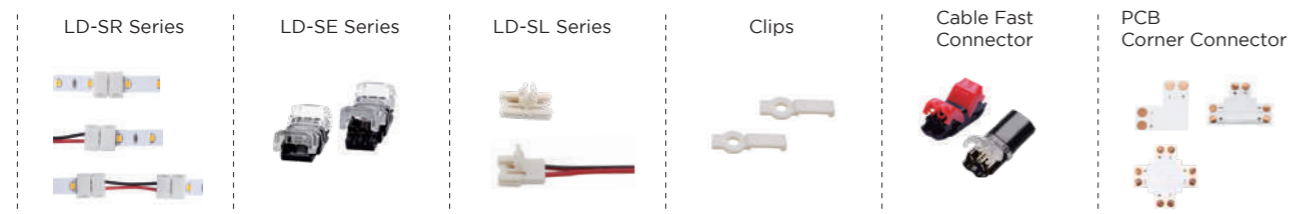

* Please Go to page 248 for Accessory and Connector Usage Guidelines.

165-190LM/W RA80

80LEDs/M 9.6W

Product NO. FH10W-P0-G1 28BL8X 24V80S8 W08L05



Technical Details

Power	9.6W/M 2.93W/ft	Lumens		ErP Class	
Voltage	DC24V	● 2700K	1620lm/m 494lm/ft	● 3000K	1660lm/m 506lm/ft
RA	80	● 4000K	1810lm/m 552lm/ft	● 5000K	1810lm/m 552lm/ft
Led Qty	80LEDs/M 24LEDs/ft	● 6000K	1775lm/m 541lm/ft		
Length/Reel	5004mm 16.41ft				
Cutting Length	100mm 3.93"				
IP Grade	IP20 / IP62 / IP65 / IP68				

Note: 'x' (CCT) = "27"(2700K) / "30"(3000K) / "40"(4000K) / "50"(5000K) / "60"(6000K), Please contact us for more information.

* Please contact our sales for the latest details and certifications

Dimension



Connectors List

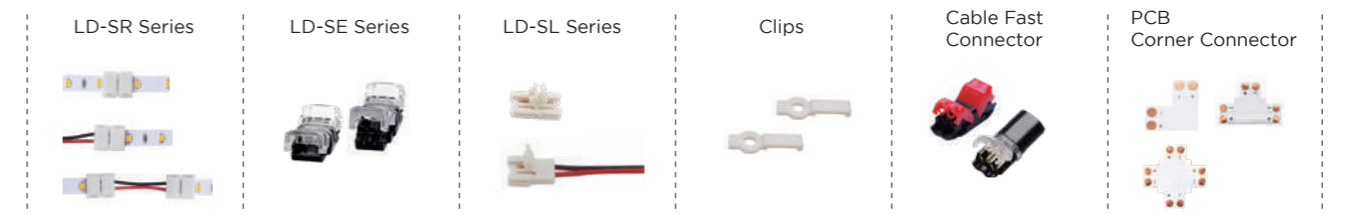

* Please Go to page 248 for Accessory and Connector Usage Guidelines.

165-190LM/W CRI80

80LEDs/M 12W

Product NO. FH12W-PO-G1 28H2G8X 24V80S8 W10L05



Technical Details

Power	12W/M 3.65W/ft	Lumens		ErP Class	
Voltage	DC24V	● 2700K	2100lm/m 640lm/ft	● D	
CRI	80	● 3000K	2140lm/m 652lm/ft	● C	
Led Qty	80LEDs/M 24LEDs/ft	● 4000K	2260lm/m 689lm/ft	● C	
Length/Reel	5004mm 16.41ft	● 5000K	2190lm/m 668lm/ft	● C	
Cutting Length	100mm 3.93"	● 6000K	2160lm/m 659lm/ft	● C	
IP Grade	IP20 / IP62 / IP65 / IP68				

Note: 'x' (CCT) = "27"(2700K) / "30"(3000K) / "40"(4000K) / "50"(5000K) / "60"(6000K), Please contact us for more information.

* Please contact our sales for the latest details and certifications

Dimension

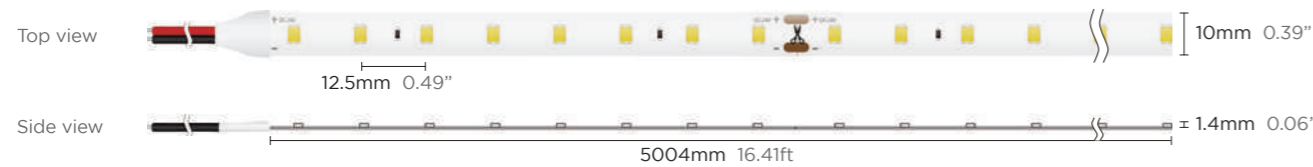

Connectors List



* Please Go to page 248 for Accessory and Connector Usage Guidelines.

165-190LM/W RA80

128LEDs/M 14.4W

Product NO. FH14W-PO-G1 28BL8X 24V128S8 W10L05



Technical Details

Power	14.4W/M 4.39W/ft	Lumens		ErP Class	
Voltage	DC24V	● 2700K	2400lm/m 732lm/ft	● D	
RA	80	● 3000K	2445lm/m 745lm/ft	● D	
Led Qty	128LEDs/M 39LEDs/ft	● 4000K	2735lm/m 834lm/ft	● C	
Length/Reel	5004mm 16.41ft	● 5000K	2735lm/m 834lm/ft	● C	
Cutting Length	62.5mm 2.46"	● 6000K	2660lm/m 811lm/ft	● C	
IP Grade	IP20 / IP62 / IP65 / IP68				

Note: 'x' (CCT) = "27"(2700K) / "30"(3000K) / "40"(4000K) / "50"(5000K) / "60"(6000K), Please contact us for more information.

* Please contact our sales for the latest details and certifications

Dimension

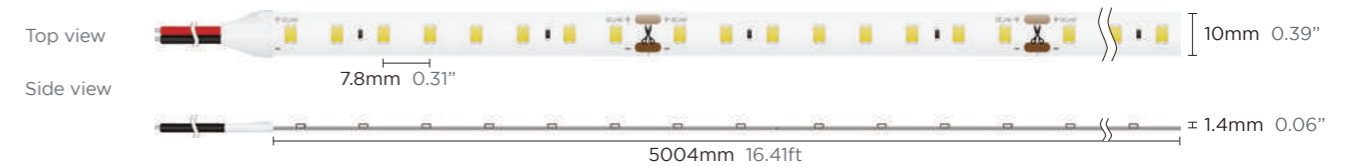

Connectors List



* Please Go to page 248 for Accessory and Connector Usage Guidelines.

165-190LM/W RA80

160LEDs/M 19.2W

Product NO. FH19W-P0-G1 28BL8X 24V160S8 W10L05



Technical Details

Power	19.2W/M 5.85W/ft	Lumens			ErP Class
Voltage	DC24V	● 2700K	3170lm/m	966lm/ft	D
RA	80	● 3000K	3320lm/m	1012lm/ft	D
Led Qty	160LEDs/M 48LEDs/ft	● 4000K	3625lm/m	1105lm/ft	C
Length/Reel	5004mm 16.41ft	● 5000K	3625lm/m	1105lm/ft	C
Cutting Length	50mm 1.96"	● 6000K	3550lm/m	1082lm/ft	C
IP Grade	IP20 / IP62 / IP65 / IP68				

Note: 'x' (CCT) = "27"(2700K) / "30"(3000K) / "40"(4000K) / "50"(5000K) / "60"(6000K), Please contact us for more information.

* Please contact our sales for the latest details and certifications

Dimension



Connectors List

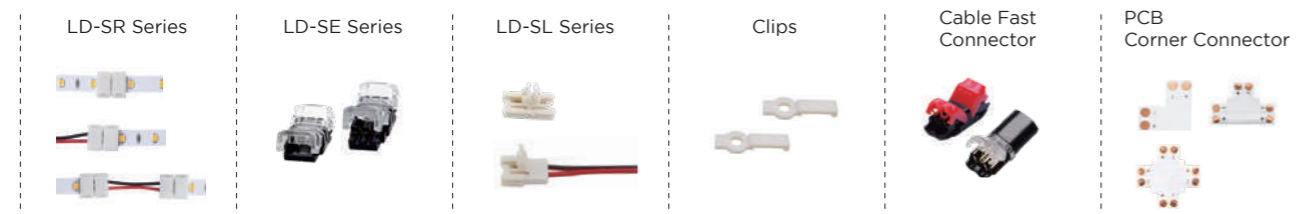

* Please Go to page 248 for Accessory and Connector Usage Guidelines.

190-215LM/W RA80



126LEDs/M 4.8W

FH05W-P0-G1 28BL8X 24V126S9 W10L05

180LEDs/M 7.2W

FH07W-P0-G1 28BL8X 24V180S9 W10L05

Power	4.8W/M 1.46W/ft	7.2W/M 2.19W/ft
Voltage	DC24V	DC24V
RA	80	80
Led Qty	126LEDs/M 38LEDs/ft	180LEDs/M 55LEDs/ft
Length/Reel	5004mm 16.41ft	5004mm 16.41ft
Cutting Length	71.4mm 2.81"	50mm 1.97"
IP Grade	IP20 / IP62 / IP65 / IP68	IP20 / IP62 / IP65 / IP68

Lumens	ErP Class		ErP Class	
● 2700K	840lm/m	256lm/ft	1260lm/m	384lm/ft
● 3000K	920lm/m	280lm/ft	1380lm/m	420lm/ft
● 4000K	995lm/m	303lm/ft	1500lm/m	457lm/ft
● 5000K	1010lm/m	308lm/ft	1510lm/m	460lm/ft
● 6000K	995lm/m	303lm/ft	1500lm/m	457lm/ft

Note: 'x' (CCT) = "27"(2700K) / "30"(3000K) / "40"(4000K) / "50"(5000K) / "60"(6000K), Please contact us for more information.

* Please contact our sales for the latest details and certifications

Dimension

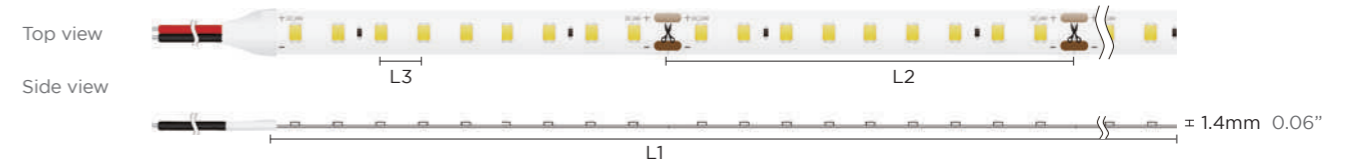

	L1	L2	L3	W4
FH05W-P0-G1 28BL8x 24V126S9 W10L05	5m 16.41ft	71.4mm 2.81"	7.93mm 0.31"	10mm 0.39"
FH07W-P0-G1 28BL8x 24V180S9 W10L05	5m 16.41ft	50mm 1.97"	5.56mm 0.22"	10mm 0.39"

Connectors List

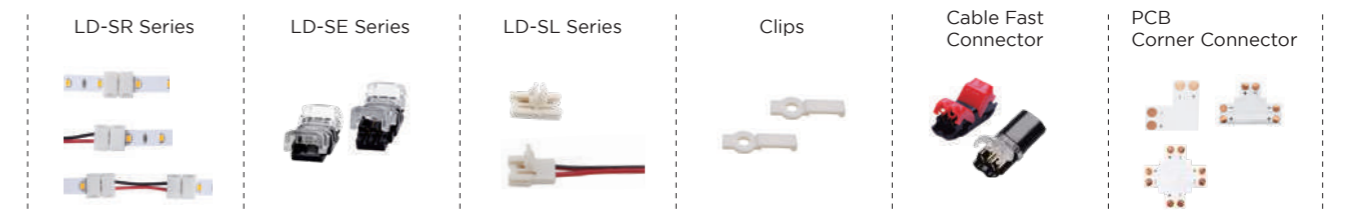

* Please Go to page 248 for Accessory and Connector Usage Guidelines.

200-215LM/W RA80

90LEDs/M 4.8W

Product NO. FH05W-P0-G1 28BL8X 24V90S9 W10L05

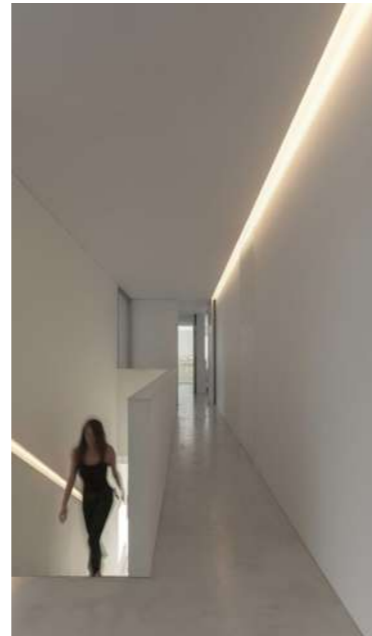

Technical Details

Power	4.8W/M 1.46W/ft	Lumens			ErP Class
Voltage	DC24V	● 2700K	950lm/m	290lm/ft	B
RA	80	● 3000K	990lm/m	302lm/ft	B
Led Qty	90LEDs/M 27LEDs/ft	● 4000K	1035lm/m	316lm/ft	B
Length/Reel	5004mm 16.41ft	● 5000K	1025lm/m	313lm/ft	B
Cutting Length	100mm 3.93"	● 6000K	1025lm/m	313lm/ft	B
IP Grade	IP20 / IP62 / IP65 / IP68				

Note: 'x' (CCT) = "27"(2700K) / "30"(3000K) / "40"(4000K) / "50"(5000K) / "60"(6000K), Please contact us for more information.

* Please contact our sales for the latest details and certifications

Dimension

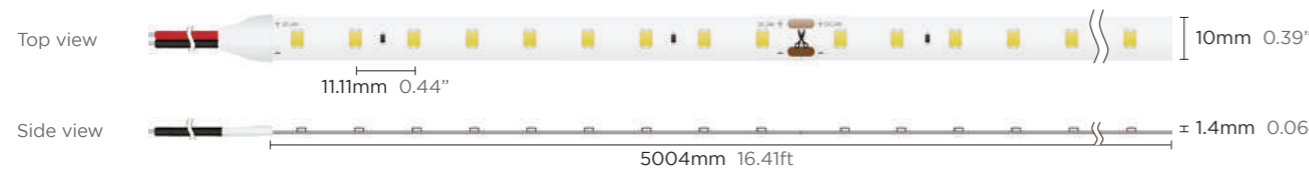

Connectors List



* Please Go to page 248 for Accessory and Connector Usage Guidelines.

200-215LM/W RA80

180LEDs/M 9.6W

Product NO. FH10W-P0-G1 28BL8X 24V180S9 W10L05

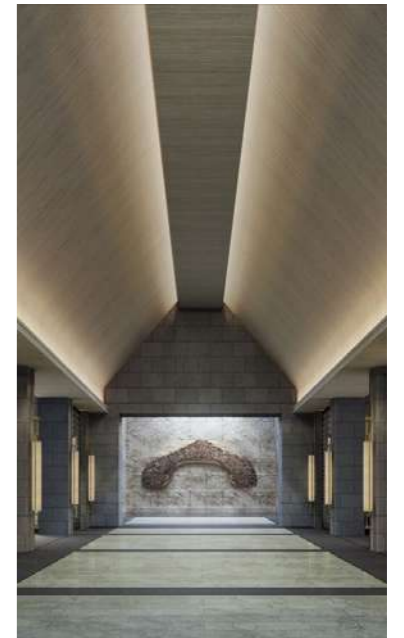

Technical Details

Power	9.6W/M 2.92W/ft	Lumens			ErP Class
Voltage	DC24V	● 2700K	1920lm/m	585lm/ft	B
RA	80	● 3000K	1985lm/m	605lm/ft	B
Led Qty	180LEDs/M 54LEDs/ft	● 4000K	2100lm/m	640lm/ft	B
Length/Reel	5004mm 16.41ft	● 5000K	2035lm/m	620lm/ft	B
Cutting Length	50mm 1.97"	● 6000K	2070lm/m	631lm/ft	B
IP Grade	IP20 / IP62 / IP65 / IP68				

Note: 'x' (CCT) = "27"(2700K) / "30"(3000K) / "40"(4000K) / "50"(5000K) / "60"(6000K), Please contact us for more information.

* Please contact our sales for the latest details and certifications

Dimension

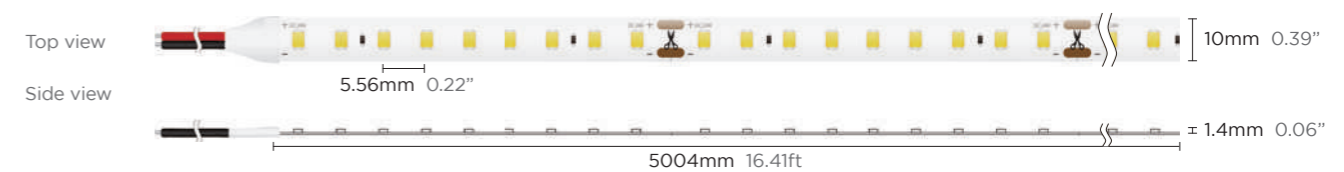

Connectors List



* Please Go to page 248 for Accessory and Connector Usage Guidelines.

110-120LM/W CRI90

70LEDs/M 4.8W

Product NO. FH05W-P0-G1 28HX9X 24V70S7 W08L05



Technical Details

Power	4.8W/M 1.46W/ft	Lumens		ErP Class								
Voltage	DC24V	● 2700K	530lm/m 162lm/ft	● 3000K	560lm/m 171lm/ft	● 4000K	600lm/m 183lm/ft	● 5000K	575lm/m 175lm/ft	● 6000K	580lm/m 177lm/ft	F
CRI	90	F	F	F	F	F	F	F	F	F	F	F
Led Qty	70LEDs/M 21LEDs/ft											
Length/Reel	5004mm 16.41ft											
Cutting Length	100mm 3.93"											
IP Grade	IP20 / IP62 / IP65 / IP68											

Note: 'x' (CCT) = "27"(2700K) / "30"(3000K) / "40"(4000K) / "50"(5000K) / "60"(6000K), Please contact us for more information.

* Please contact our sales for the latest details and certifications

Dimension

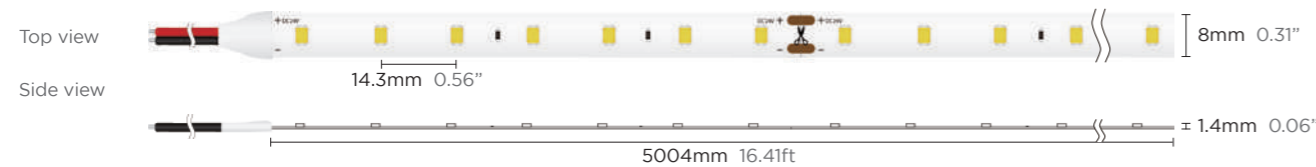

Connectors List

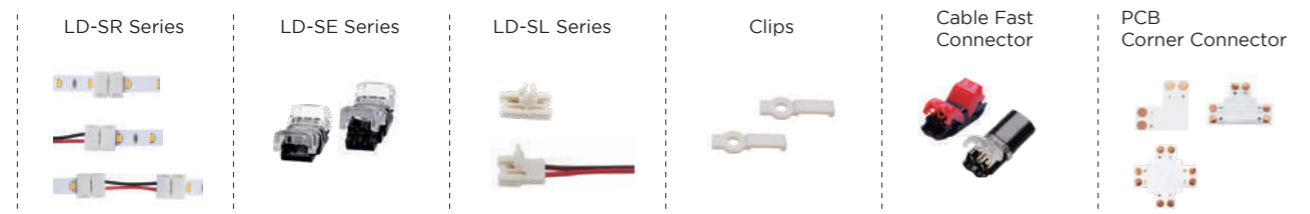

* Please Go to page 248 for Accessory and Connector Usage Guidelines.

110-120LM/W CRI90

140LEDs/M 9.6W

Product NO. FH10W-P0-G1 28HX9X 24V140S7 W08L05



Technical Details

Power	9.6W/M 2.93W/ft	Lumens		ErP Class								
Voltage	DC24V	● 2700K	1055lm/m 322lm/ft	● 3000K	1105lm/m 337lm/ft	● 4000K	1185lm/m 361lm/ft	● 5000K	1085lm/m 331lm/ft	● 6000K	1115lm/m 340lm/ft	F
CRI	90	F	F	F	F	F	F	F	F	F	F	F
Led Qty	140LEDs/M 42LEDs/ft											
Length/Reel	5004mm 16.41ft											
Cutting Length	50mm 1.97"											
IP Grade	IP20 / IP62 / IP65 / IP68											

Note: 'x' (CCT) = "27"(2700K) / "30"(3000K) / "40"(4000K) / "50"(5000K) / "60"(6000K), Please contact us for more information.

* Please contact our sales for the latest details and certifications

Dimension

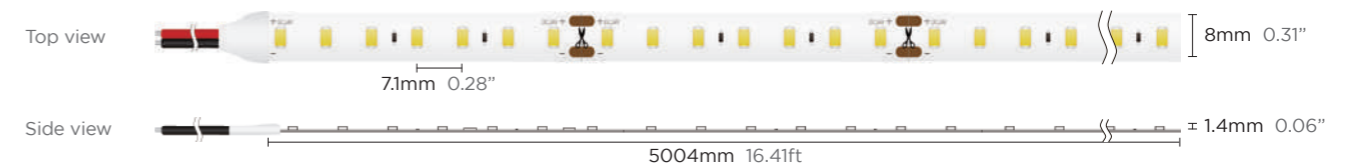

Connectors List



* Please Go to page 248 for Accessory and Connector Usage Guidelines.

110-120LM/W CRI90

210LEDs/M 14.4W

Product NO. FH14W-P0-G1 28HX9X 24V210S7 W10L05



Technical Details

Power	14.4W/M 4.39W/ft	Lumens			ErP Class
Voltage	DC24V	● 2700K	1655lm/m	505lm/ft	F
CRI	90	● 3000K	1700lm/m	518lm/ft	F
Led Qty	210LEDs/M 64LEDs/ft	● 4000K	1845lm/m	563lm/ft	F
Length/Reel	5004mm 16.41ft	● 5000K	1845lm/m	563lm/ft	F
Cutting Length	33.3mm 1.31"	● 6000K	1730lm/m	527lm/ft	F
IP Grade	IP20 / IP62 / IP65 / IP68				

Note: 'x' (CCT) = "27"(2700K) / "30"(3000K) / "40"(4000K) / "50"(5000K) / "60"(6000K), Please contact us for more information.

* Please contact our sales for the latest details and certifications

Dimension

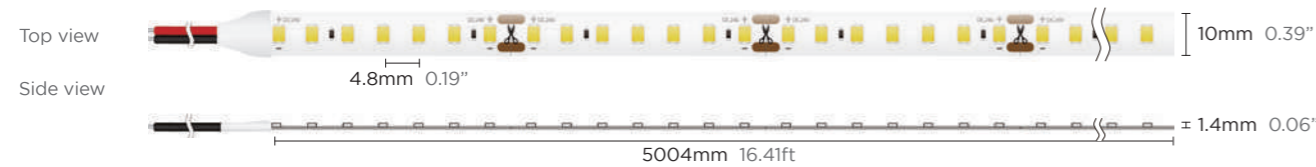

Connectors List



* Please Go to page 248 for Accessory and Connector Usage Guidelines.

110-120LM/W CRI90

252LEDs/M 19.2W

Product NO. FH19W-P0-G1 28HX9X 24V252S7 W10L05



Technical Details

Power	19.2W/M 5.85W/ft	Lumens			ErP Class
Voltage	DC24V	● 2700K	2215lm/m	675lm/ft	F
CRI	90	● 3000K	2265lm/m	691lm/ft	F
Led Qty	252LEDs/M 76LEDs/ft	● 4000K	2300lm/m	701lm/ft	F
Length/Reel	5004mm 16.41ft	● 5000K	2300lm/m	701lm/ft	F
Cutting Length	27.8mm 1.09"	● 6000K	2300lm/m	701lm/ft	F
IP Grade	IP20 / IP62 / IP65 / IP68				

Note: 'x' (CCT) = "27"(2700K) / "30"(3000K) / "40"(4000K) / "50"(5000K) / "60"(6000K), Please contact us for more information.

* Please contact our sales for the latest details and certifications

Dimension

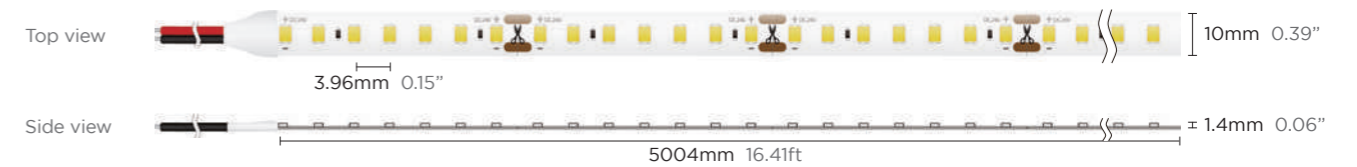

Connectors List



* Please Go to page 248 for Accessory and Connector Usage Guidelines.

125-140LM/W CRI90

64LEDs/M 4.8W

Product NO. FH05W-P0-G1 28HX9X 24V64S8 W08L05



Technical Details

Power	4.8W/M 1.46W/ft	Lumens			ErP Class
Voltage	DC24V	● 2700K	615lm/m	188lm/ft	E
CRI	90	● 3000K	625lm/m	191lm/ft	E
Led Qty	64LEDs/M 19LEDs/ft	● 4000K	660lm/m	201lm/ft	E
Length/Reel	5004mm 16.41ft	● 5000K	660lm/m	201lm/ft	E
Cutting Length	125mm 4.92"	● 6000K	660lm/m	201lm/ft	E
IP Grade	IP20 / IP62 / IP65 / IP68				

Note: 'x' (CCT) = "27"(2700K) / "30"(3000K) / "40"(4000K) / "50"(5000K) / "60"(6000K), Please contact us for more information.

* Please contact our sales for the latest details and certifications

Dimension

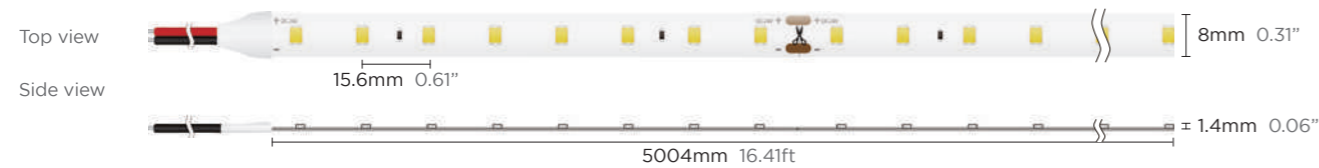

Connectors List

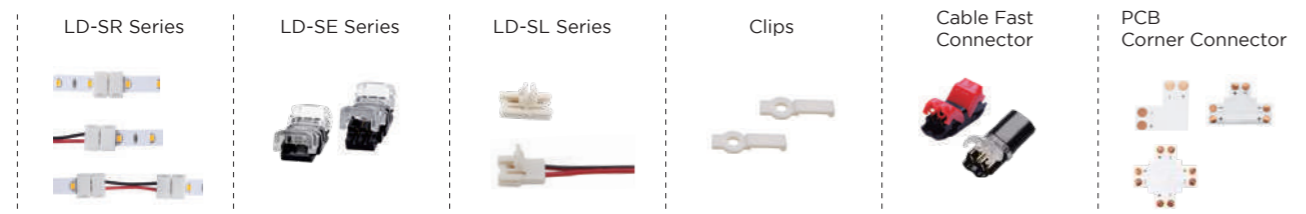

* Please Go to page 248 for Accessory and Connector Usage Guidelines.

125-140LM/W CRI90

80LEDs/M 9.6W

Product NO. FH10W-P0-G1 28HX9X 24V80S8 W08L05



Technical Details

Power	9.6W/M 2.93W/ft	Lumens			ErP Class
Voltage	DC24V	● 2700K	1230lm/m	375lm/ft	E
CRI	90	● 3000K	1250lm/m	381lm/ft	E
Led Qty	80LEDs/M 24LEDs/ft	● 4000K	1295lm/m	395lm/ft	E
Length/Reel	5004mm 16.41ft	● 5000K	1295lm/m	395lm/ft	E
Cutting Length	100mm 3.93"	● 6000K	1295lm/m	395lm/ft	E
IP Grade	IP20 / IP62 / IP65 / IP68				

Note: 'x' (CCT) = "27"(2700K) / "30"(3000K) / "40"(4000K) / "50"(5000K) / "60"(6000K), Please contact us for more information.

* Please contact our sales for the latest details and certifications

Dimension

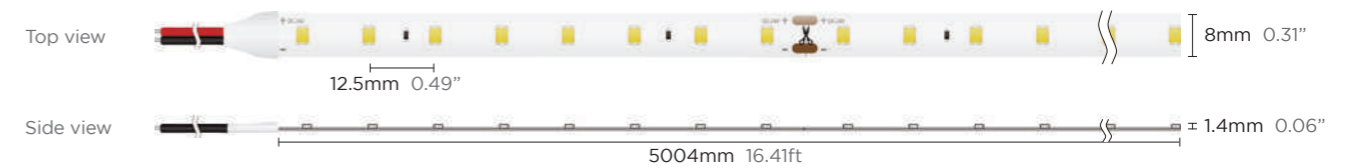

Connectors List



* Please Go to page 248 for Accessory and Connector Usage Guidelines.

125-140LM/W CRI90

128LEDs/M 9.6W

Product NO. FH10W-PO-G1 28HX9X 24V128S8 W10L05



Technical Details

Power	9.6W/M 2.93W/ft	Lumens			ErP Class
Voltage	DC24V	● 2700K	1250lm/m	381lm/ft	E
CRI	90	● 3000K	1270lm/m	387lm/ft	E
Led Qty	128LEDs/M 39LEDs/ft	● 4000K	1325lm/m	404lm/ft	E
Length/Reel	5004mm 16.41ft	● 5000K	1325lm/m	404lm/ft	E
Cutting Length	62.5mm 2.46"	● 6000K	1325lm/m	404lm/ft	E
IP Grade	IP20 / IP62 / IP65 / IP68				

Note: 'x' (CCT) = "27"(2700K) / "30"(3000K) / "40"(4000K) / "50"(5000K) / "60"(6000K), Please contact us for more information.

* Please contact our sales for the latest details and certifications

Dimension

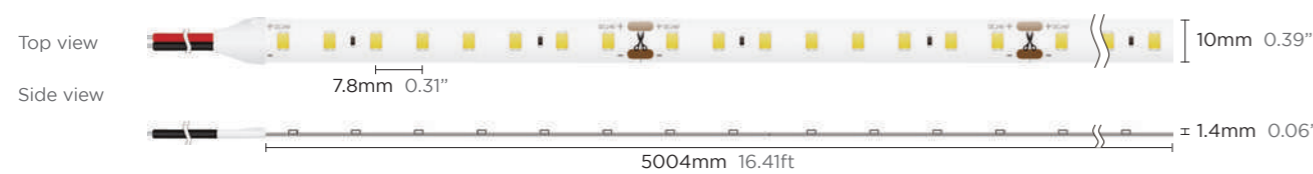

Connectors List



* Please Go to page 248 for Accessory and Connector Usage Guidelines.

125-140LM/W CRI90

160LEDs/M 14.4W

Product NO. FH14W-PO-G1 28HX9X 24V160S8 W10L05

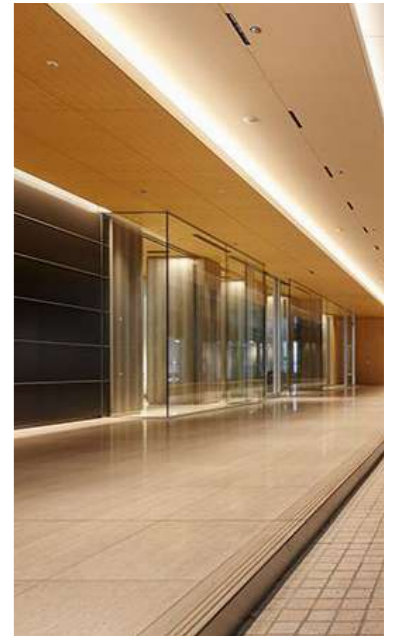

Technical Details

Power	14.4W/M 4.39W/ft	Lumens			ErP Class
Voltage	DC24V	● 2700K	1845lm/m	563lm/ft	E
CRI	90	● 3000K	1870lm/m	570lm/ft	E
Led Qty	160LEDs/M 48LEDs/ft	● 4000K	1945lm/m	593lm/ft	E
Length/Reel	5004mm 16.41ft	● 5000K	1945lm/m	593lm/ft	E
Cutting Length	50mm 1.96"	● 6000K	1945lm/m	593lm/ft	E
IP Grade	IP20 / IP62 / IP65 / IP68				

Note: 'x' (CCT) = "27"(2700K) / "30"(3000K) / "40"(4000K) / "50"(5000K) / "60"(6000K), Please contact us for more information.

* Please contact our sales for the latest details and certifications

Dimension

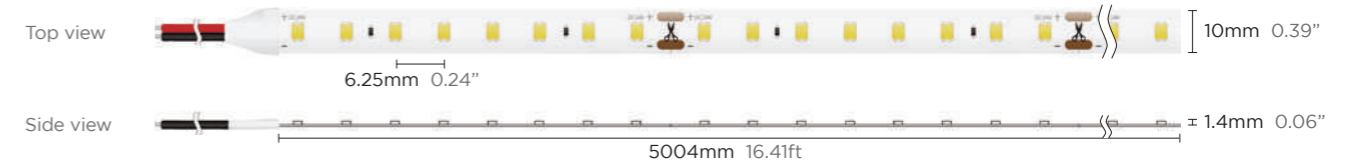

Connectors List



* Please Go to page 248 for Accessory and Connector Usage Guidelines.

140-165LM/W RA90

64LEDs/M 4.8W

Product NO. FH05W-P0-G1 28BL9X 24V64S8 W08L05



Technical Details

Power	4.8W/M 1.46W/ft	Lumens			ErP Class
Voltage	DC24V	● 2700K	700lm/m	213lm/ft	E
RA	90	● 3000K	725lm/m	221lm/ft	D
Led Qty	64LEDs/M 19LEDs/ft	● 4000K	810lm/m	247lm/ft	D
Length/Reel	5004mm 16.41ft	● 5000K	770lm/m	235lm/ft	D
Cutting Length	125mm 4.92"	● 6000K	770lm/m	235lm/ft	D
IP Grade	IP20 / IP62 / IP65 / IP68				

Note: 'x' (CCT) = "27"(2700K) / "30"(3000K) / "40"(4000K) / "50"(5000K) / "60"(6000K), Please contact us for more information.

* Please contact our sales for the latest details and certifications

Dimension

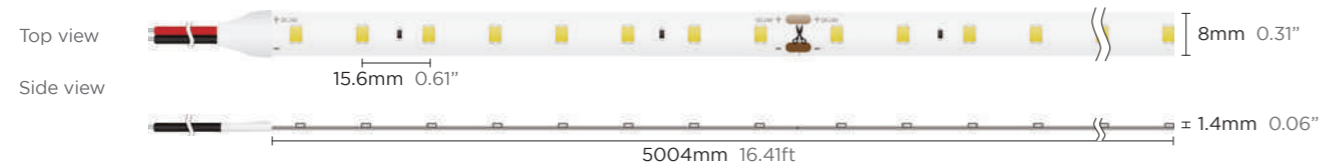

Connectors List



* Please Go to page 248 for Accessory and Connector Usage Guidelines.

140-165LM/W RA90

80LEDs/M 9.6W

Product NO. FH10W-P0-G1 28BL9X 24V80S8 W08L05

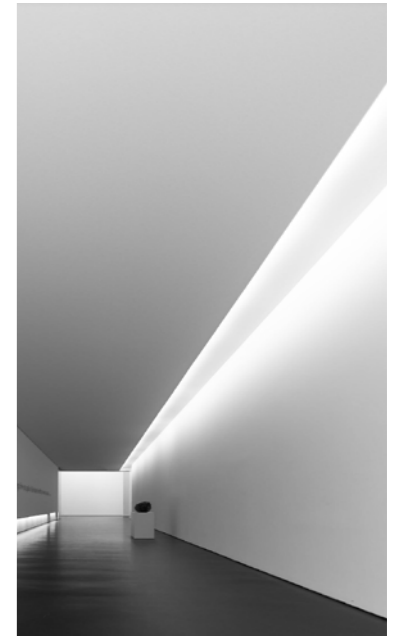

Technical Details

Power	9.6W/M 2.93W/ft	Lumens			ErP Class
Voltage	DC24V	● 2700K	1360lm/m	415lm/ft	E
RA	90	● 3000K	1445lm/m	441lm/ft	D
Led Qty	80LEDs/M 24LEDs/ft	● 4000K	1585lm/m	483lm/ft	D
Length/Reel	5004mm 16.41ft	● 5000K	1475lm/m	450lm/ft	D
Cutting Length	100mm 3.93"	● 6000K	1525lm/m	465lm/ft	D
IP Grade	IP20 / IP62 / IP65 / IP68				

Note: 'x' (CCT) = "27"(2700K) / "30"(3000K) / "40"(4000K) / "50"(5000K) / "60"(6000K), Please contact us for more information.

* Please contact our sales for the latest details and certifications

Dimension



Connectors List



* Please Go to page 248 for Accessory and Connector Usage Guidelines.

140-165LM/W RA90

128LEDs/M 14.4W

Product NO. FH14W-PO-G1 28BL9X 24V128S8 W10L05



140-165LM/W RA90

160LEDs/M 19.2W

Product NO. FH19W-PO-G1 28BL9X 24V160S8 W10L05

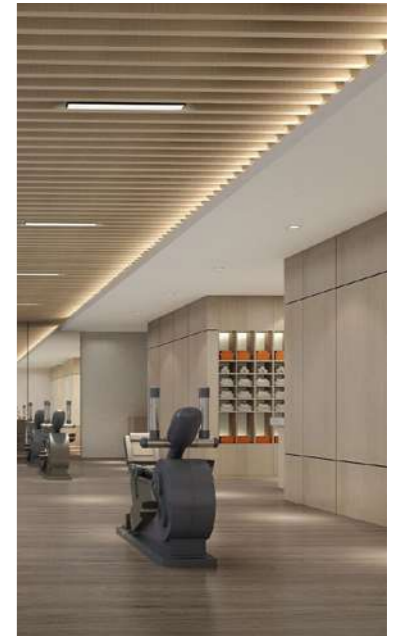

Technical Details

Power	14.4W/M 4.39W/ft	Lumens		ErP Class	
Voltage	DC24V	● 2700K	2085lm/m 636lm/ft	● E	
RA	90	● 3000K	2160lm/m 659lm/ft	● D	
Led Qty	128LEDs/M 39LEDs/ft	● 4000K	2430lm/m 741lm/ft	● D	
Length/Reel	5004mm 16.41ft	● 5000K	2245lm/m 684lm/ft	● D	
Cutting Length	62.5mm 2.46"	● 6000K	2260lm/m 689lm/ft	● D	
IP Grade	IP20 / IP62 / IP65 / IP68				

Note: 'x' (CCT) = "27"(2700K) / "30"(3000K) / "40"(4000K) / "50"(5000K) / "60"(6000K), Please contact us for more information.

* Please contact our sales for the latest details and certifications

Dimension

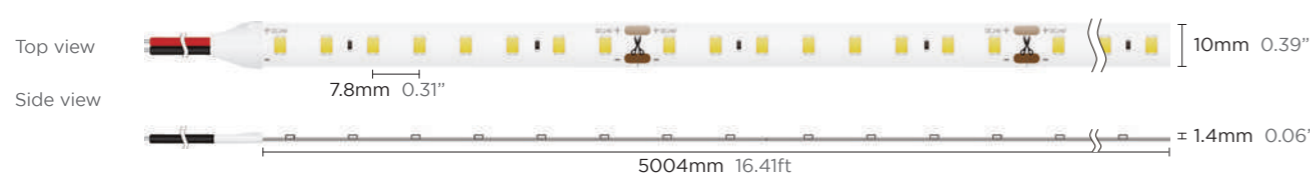

Connectors List



* Please Go to page 248 for Accessory and Connector Usage Guidelines.

Technical Details

Power	19.2W/M 5.85W/ft	Lumens		ErP Class	
Voltage	DC24V	● 2700K	2725lm/m 831lm/ft	● E	
RA	90	● 3000K	2895lm/m 883lm/ft	● D	
Led Qty	160LEDs/M 48LEDs/ft	● 4000K	3185lm/m 971lm/ft	● D	
Length/Reel	5004mm 16.41ft	● 5000K	2975lm/m 907lm/ft	● D	
Cutting Length	50mm 1.96"	● 6000K	3010lm/m 918lm/ft	● D	
IP Grade	IP20 / IP62 / IP65 / IP68				

Note: 'x' (CCT) = "27"(2700K) / "30"(3000K) / "40"(4000K) / "50"(5000K) / "60"(6000K), Please contact us for more information.

* Please contact our sales for the latest details and certifications

Dimension



Connectors List



* Please Go to page 248 for Accessory and Connector Usage Guidelines.

165-180LM/W RA90

126LEDs/M 4.8W

Product NO. FH05W-P0-G1 28BL9X 24V126S9 W10L05

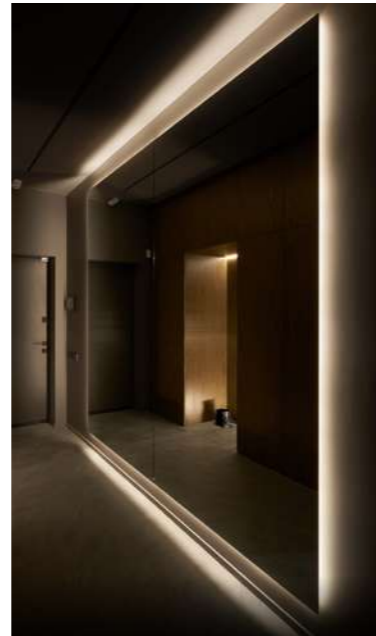

Technical Details

Power	4.8W/M 1.46W/ft	Lumens		ErP Class	
Voltage	DC24V	● 2700K	755lm/m 230lm/ft	● D	
RA	90	● 3000K	825lm/m 252lm/ft	● D	
Led Qty	126LEDs/M 38LEDs/ft	● 4000K	865lm/m 264lm/ft	● C	
Length/Reel	5004mm 16.41ft	● 5000K	865lm/m 264lm/ft	● C	
Cutting Length	71.4mm 2.81"	● 6000K	865lm/m 264lm/ft	● C	
IP Grade	IP20 / IP62 / IP65 / IP68				

Note: 'x' (CCT) = "27"(2700K) / "30"(3000K) / "40"(4000K) / "50"(5000K) / "60"(6000K), Please contact us for more information.

* Please contact our sales for the latest details and certifications

Dimension

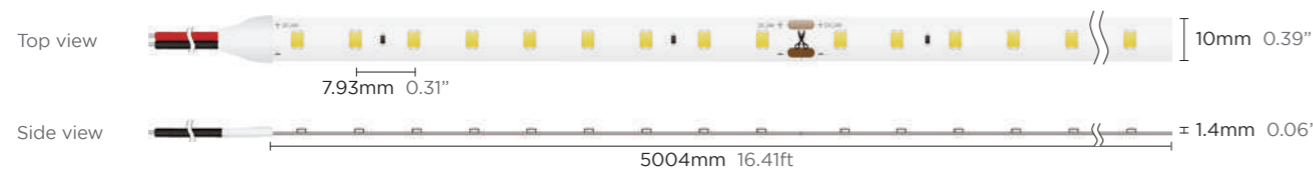

Connectors List

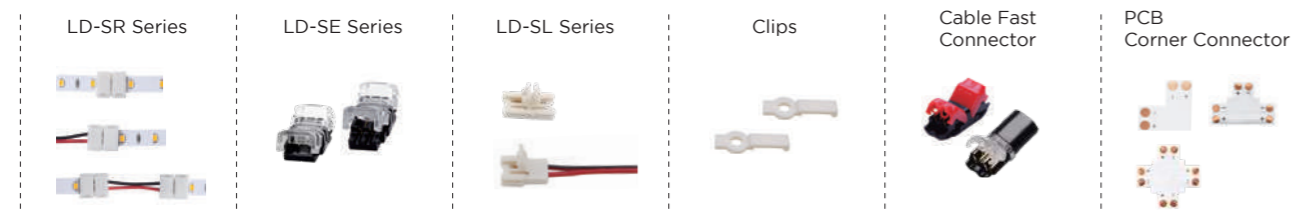

* Please Go to page 248 for Accessory and Connector Usage Guidelines.

165-180LM/W RA90

180LEDs/M 7.2W

Product NO. FH07W-P0-G1 28BL9X 24V180S9 W10L05



Technical Details

Power	7.2W/M 2.19W/ft	Lumens		ErP Class	
Voltage	DC24V	● 2700K	1135lm/m 346lm/ft	● E	
RA	90	● 3000K	1225lm/m 373lm/ft	● D	
Led Qty	180LEDs/M 54LEDs/ft	● 4000K	1300lm/m 396lm/ft	● D	
Length/Reel	5004mm 16.41ft	● 5000K	1300lm/m 396lm/ft	● D	
Cutting Length	50mm 1.97"	● 6000K	1300lm/m 396lm/ft	● D	
IP Grade	IP20 / IP62 / IP65 / IP68				

Note: 'x' (CCT) = "27"(2700K) / "30"(3000K) / "40"(4000K) / "50"(5000K) / "60"(6000K), Please contact us for more information.

* Please contact our sales for the latest details and certifications

Dimension

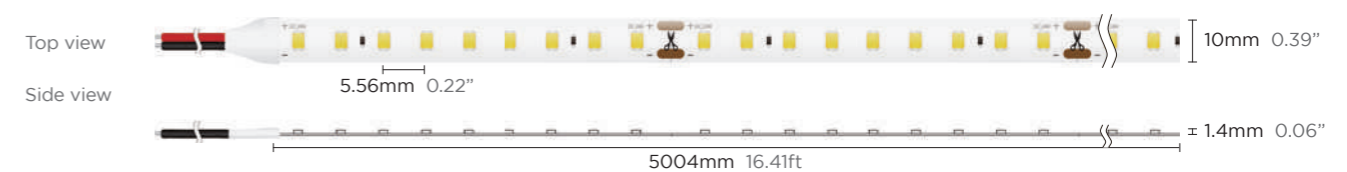

Connectors List

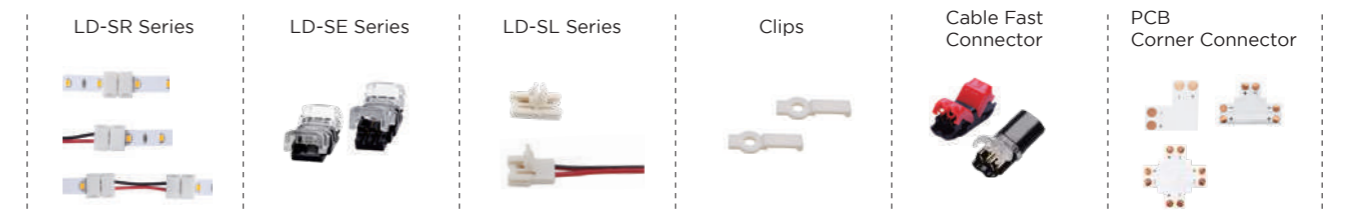

* Please Go to page 248 for Accessory and Connector Usage Guidelines.

170-195LM/W RA90

90LEDs/M 4.8W

Product NO. FH05W-P0-G1 28BL9X 24V90S9 W10L05



Technical Details

Power	4.8W/M 1.46W/ft	Lumens		ErP Class	
Voltage	DC24V	● 2700K	825lm/m 252lm/ft	● E	
RA	90	● 3000K	840lm/m 256lm/ft	● D	
Led Qty	90LEDs/M 27LEDs/ft	● 4000K	930lm/m 284lm/ft	● D	
Length/Reel	5004mm 16.41ft	● 5000K	930lm/m 284lm/ft	● D	
Cutting Length	100mm 3.93"	● 6000K	930lm/m 284lm/ft	● D	
IP Grade	IP20 / IP62 / IP65 / IP68				

Note: 'x' (CCT) = "27"(2700K) / "30"(3000K) / "40"(4000K) / "50"(5000K) / "60"(6000K), Please contact us for more information.

* Please contact our sales for the latest details and certifications

Dimension

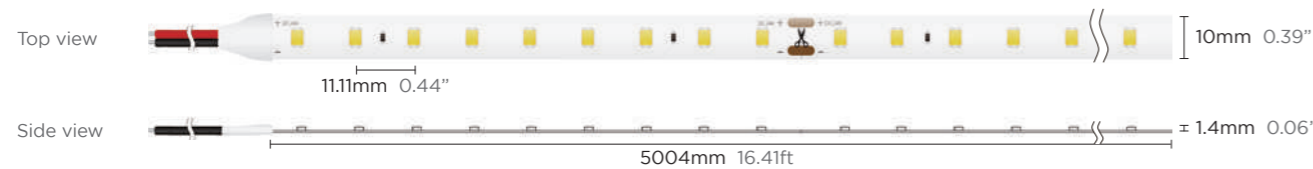

Connectors List

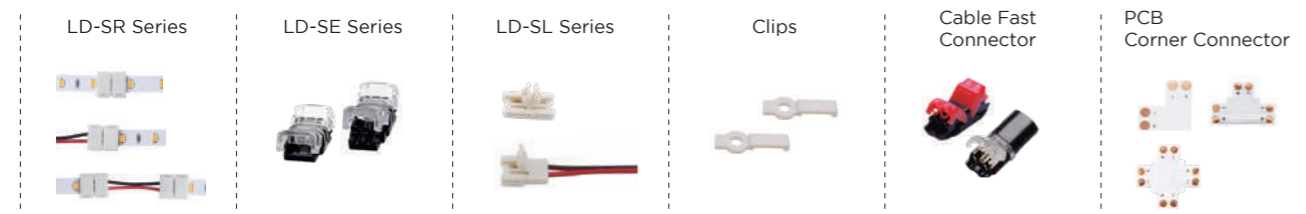

* Please Go to page 248 for Accessory and Connector Usage Guidelines.

170-195LM/W RA90

180LEDs/M 9.6W

Product NO. FH10W-P0-G1 28BL9X 24V180S9 W10L05



Technical Details

Power	9.6W/M 2.92W/ft	Lumens		ErP Class	
Voltage	DC24V	● 2700K	1660lm/m 506lm/ft	● E	
RA	90	● 3000K	1670lm/m 509lm/ft	● D	
Led Qty	180LEDs/M 54LEDs/ft	● 4000K	1830lm/m 558lm/ft	● D	
Length/Reel	5004mm 16.41ft	● 5000K	1830lm/m 558lm/ft	● D	
Cutting Length	50mm 1.97"	● 6000K	1830lm/m 558lm/ft	● D	
IP Grade	IP20 / IP62 / IP65 / IP68				

Note: 'x' (CCT) = "27"(2700K) / "30"(3000K) / "40"(4000K) / "50"(5000K) / "60"(6000K), Please contact us for more information.

* Please contact our sales for the latest details and certifications

Dimension

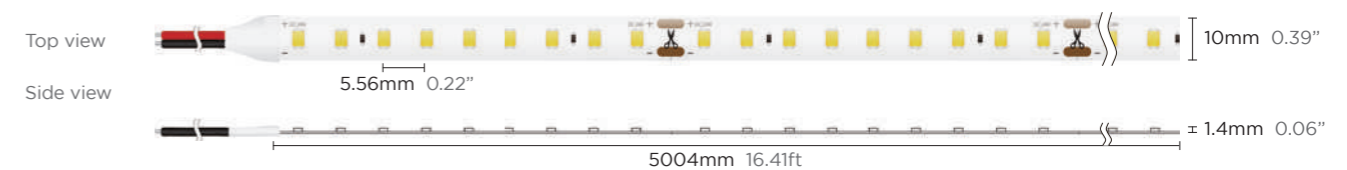

Connectors List



* Please Go to page 248 for Accessory and Connector Usage Guidelines.

185-205LM/W RA90

90LEDs/M 4.8W

Product NO. FH04W-P0-G1 28BLH9x 24V90S9 W10L05



Technical Details

Power	4W/M 1.21W/ft	Lumens		ErP Class	
Voltage	DC24V	● 2700K	670lm/m 204lm/ft		E
RA	90	● 3000K	685lm/m 209lm/ft		D
Led Qty	90LEDs/M 27LEDs/ft	● 4000K	730lm/m 222lm/ft		D
Length/Reel	5004mm 16.41ft	● 5000K	730lm/m 222lm/ft		D
Cutting Length	100mm 3.93"	● 6000K	730lm/m 222lm/ft		D
IP Grade	IP20 / IP62 / IP65 / IP68				

Note: 'x' (CCT) = "27"(2700K) / "30"(3000K) / "40"(4000K) / "50"(5000K) / "60"(6000K), Please contact us for more information.

* Please contact our sales for the latest details and certifications

Dimension

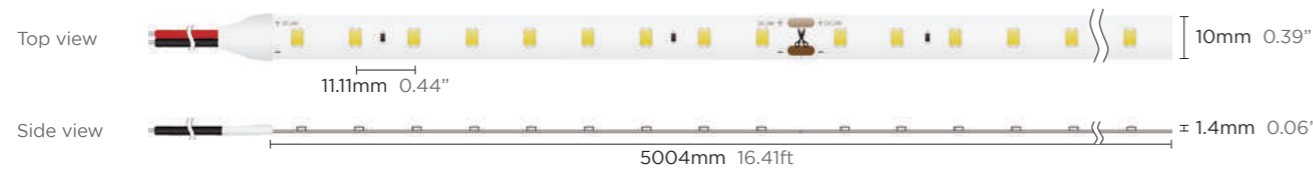

Connectors List

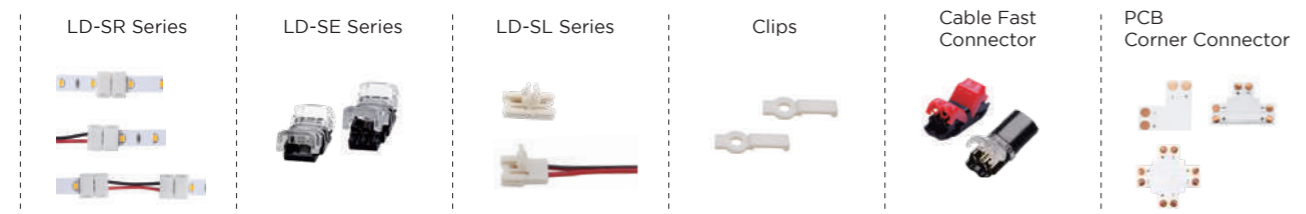

* Please Go to page 248 for Accessory and Connector Usage Guidelines.

185-205LM/W RA90

180LEDs/M 9.6W

Product NO. FH08W-P0-G1 28BLH9x 24V180S9 W10L05



Technical Details

Power	8W/M 2.43W/ft	Lumens		ErP Class	
Voltage	DC24V	● 2700K	1515lm/m 462lm/ft		E
RA	90	● 3000K	1520lm/m 463lm/ft		D
Led Qty	180LEDs/M 54LEDs/ft	● 4000K	1640lm/m 500lm/ft		D
Length/Reel	5004mm 16.41ft	● 5000K	1640lm/m 500lm/ft		D
Cutting Length	50mm 1.97"	● 6000K	1640lm/m 500lm/ft		D
IP Grade	IP20 / IP62 / IP65 / IP68				

Note: 'x' (CCT) = "27"(2700K) / "30"(3000K) / "40"(4000K) / "50"(5000K) / "60"(6000K), Please contact us for more information.

* Please contact our sales for the latest details and certifications

Dimension

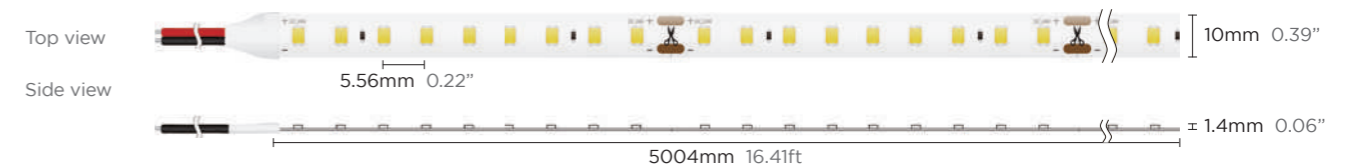

Connectors List

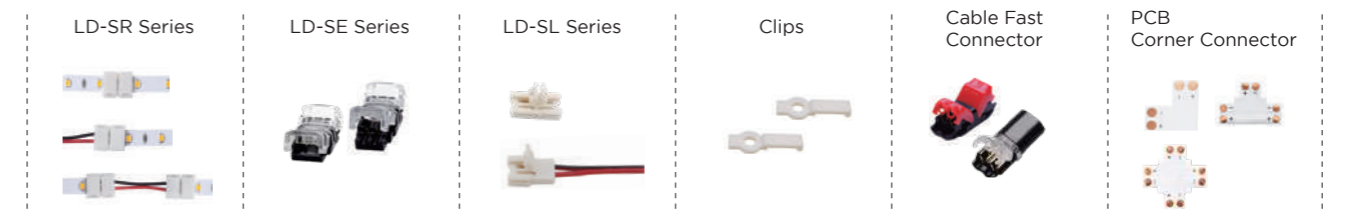

* Please Go to page 248 for Accessory and Connector Usage Guidelines.

Energy-Saving Series



Energy-saving 20%

Better than standard strip lights.
Save electricity
and reduce carbon emissions.



Energy-Saving Series

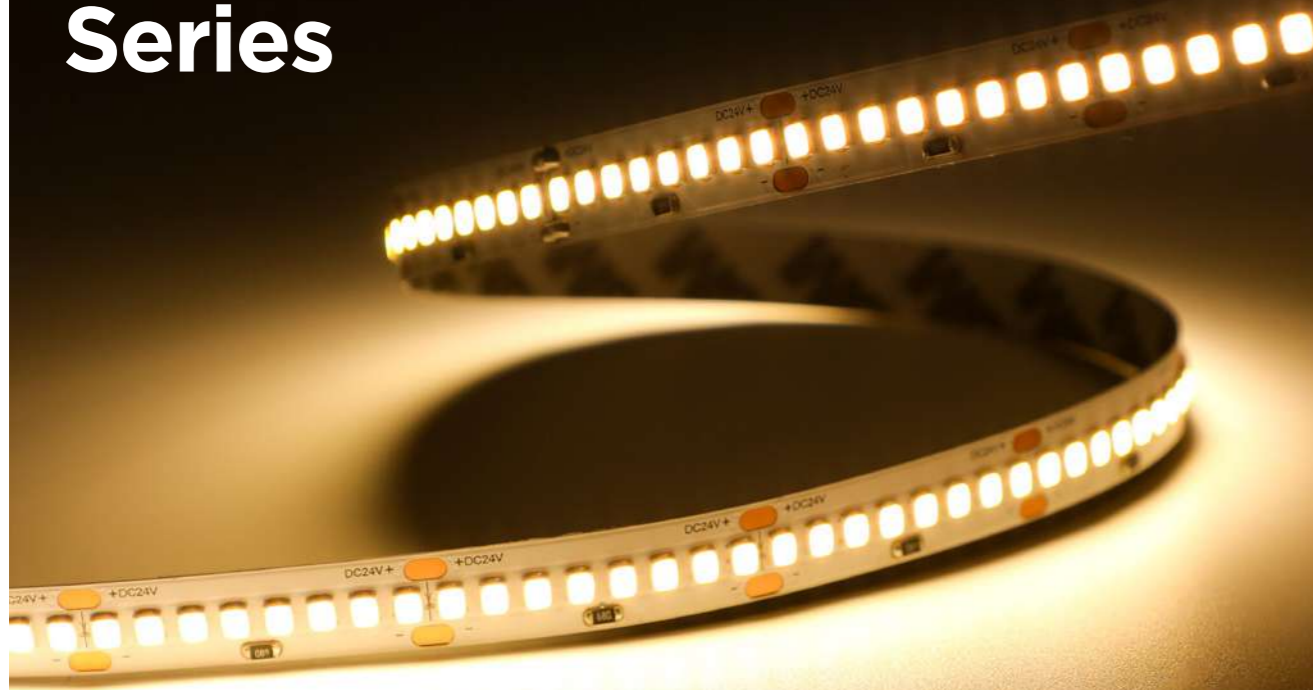

Optional 3 or 5 year warranty.

LED STRIP SERIES · ENERGY-SAVING SERIES



IP Grade

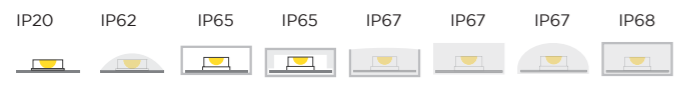

Connectors List



* Please Go to page 248 for Accessory and Connector Usage Guidelines.

4W 64LEDs/M

FH04W-PO-G1 28HX9x 24V64S8 W08L05

Power	3.6W/M 1.09W/ft	7.2W/M 2.19W/ft
Voltage	DC24V	DC24V
CRI	90	90
Led Qty	64LEDs/M 19LEDs/ft	128LEDs/M 39LEDs/ft
Length/Reel	5M 16.41ft	5M 16.41ft

7W 128LEDs/M

FH07W-PO-G1 28HX9x 24V128S8 W08L05

11W 192LEDs/M

FH11W-PO-G1 28HX9x 24V192S8 W10L05

Power	11W/M 3.35W/ft	15W/M 4.57W/ft
Voltage	DC24V	DC24V
CRI	90	90
Led Qty	192LEDs/M 58LEDs/ft	240LEDs/M 73LEDs/ft
Length/Reel	5M 16.41ft	5M 16.41ft

15W 240LEDs/M

FH15W-PO-G1 28HX9x 24V240S8 W10L05

Lumens

	4W 64LEDs/M	7W 128LEDs/M	11W 192LEDs/M	15W 240LEDs/M
2700K	445lm/m 136lm/ft	885lm/m 270lm/ft	1355lm/m 413lm/ft	1845lm/m 562lm/ft
3000K	470lm/m 143lm/ft	940lm/m 287lm/ft	1365lm/m 416lm/ft	1900lm/m 579lm/ft
4000K	475lm/m 145lm/ft	950lm/m 290lm/ft	1400lm/m 427lm/ft	1920lm/m 585lm/ft
5000K	475lm/m 145lm/ft	950lm/m 290lm/ft	1400lm/m 427lm/ft	1920lm/m 585lm/ft
6000K	475lm/m 145lm/ft	950lm/m 290lm/ft	1400lm/m 427lm/ft	1920lm/m 585lm/ft

Note: 'x' (CCT) = "27"(2700K) / "30"(3000K) / "40"(4000K) / "50"(5000K) / "60"(6000K), Please contact us for more information.

LED STRIP SERIES · ENERGY-SAVING SERIES

Dimension



	L1	L2	L3	W4
FH09W-PO-G1 28HZ9X 24V30S W08L05	5m 16.41ft	125mm 4.92"	15.6mm 0.61"	8mm 0.31"
FH10W-PO-G1 28HZ9X 24V60S W08L05	5m 16.41ft	62.5mm 2.46"	7.8mm 0.31"	8mm 0.31"
FH14W-PO-G1 28HZ9X 24V60S W10L05	5m 16.41ft	41.7mm 1.64"	5.21mm 0.2"	10mm 0.39"
FH19W-PO-G1 28HZ9X 24V120S W10L05	5m 16.41ft	33.3mm 1.31"	4.16mm 0.16"	10mm 0.39"

Spotless Lighting Series



Free Cut



Beam angle 180°



Higher efficiency



Dots-free

Connector

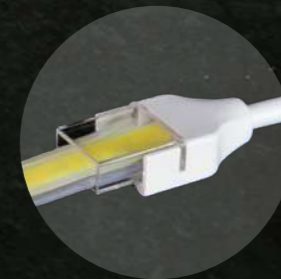
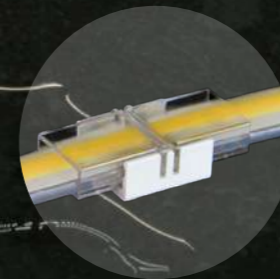



Beam angle 180°.
High efficacy 2216 Plus LED inside, Uniform luminescence, Spotless.
Bendable at horizontal direction.
Extrusion process, 3M tape, Easy installation.

8x4.5mm 12W

Extrusion process



	Free Cut	Mini Cut
Product NO.	FEN12W-P2-G2 22X9X 24V300S1 0845L05	FEN12W-P2-G2 22X9X 24V288S8 0845L05
Voltage	DC24V	DC24V
Power	12W/M 3.66W/ft	12W/M 3.66W/ft
CRI	90	90
Led Qty	300LEDs/M 91LEDs/ft	288LEDs/M 88LEDs/ft
Cutting Length	Free Cut (20mm 0.79" Soldering pad distance)	27.77mm 1.09"
IP Grade	IP62	IP62
Length/Reel	5050mm 16.56ft	5050mm 16.56ft
Lumens		
● 2700K	885lm/m 270lm/ft	1295lm/m 395lm/ft
● 3000K	935lm/m 285lm/ft	1345lm/m 410lm/ft
● 4000K	970lm/m 296lm/ft	1380lm/m 421lm/ft
○ 6000K	970lm/m 296lm/ft	1380lm/m 421lm/ft

Note: 'x' (CCT) = "27"(2700K) / "30"(3000K) / "40"(4000K) / "50"(5000K) / "60"(6000K). Please contact us for more information.

Dimension

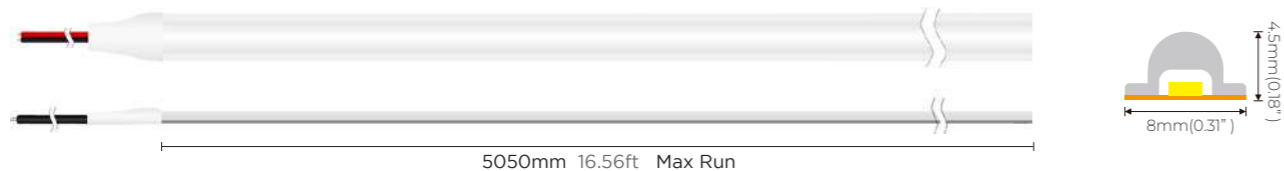

Beam angle 180°.
High efficacy 2216 Plus LED inside, Uniform luminescence, Spotless.
Bendable at horizontal direction.
Extrusion process, 3M tape, true outdoor application.

10x4.5mm 12W

Extrusion process



	Free Cut	Mini Cut
Product NO.	FEN12W-P7-G1 22X9x 24V300S1 1045L05	FEN12W-P7-G1 22X9x 24V288S8 1045L05
Voltage	DC24V	DC24V
Power	12W/M 3.66W/ft	12W/M 3.66W/ft
CRI	90	90
Led Qty	300LEDs/M 91LEDs/ft	288LEDs/M 88LEDs/ft
Cutting Length	Free Cut (20mm 0.79" Soldering pad distance)	27.77mm 1.09"
IP Grade	IP67	IP67
Length/Reel	5050mm 16.56ft	5050mm 16.56ft
Lumens		
● 2700K	815lm/m 248lm/ft	1220lm/m 372lm/ft
● 3000K	850lm/m 259lm/ft	1260lm/m 384lm/ft
● 4000K	910lm/m 277lm/ft	1295lm/m 395lm/ft
○ 6000K	910lm/m 277lm/ft	1295lm/m 395lm/ft

Note: 'x' (CCT) = "27"(2700K) / "30"(3000K) / "40"(4000K) / "50"(5000K) / "60"(6000K). Please contact us for more information.

Dimension

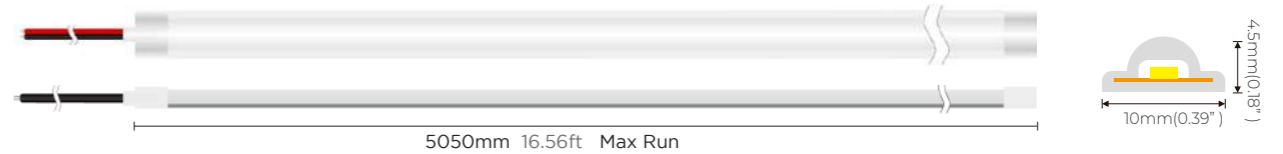



Beam angle 180°.
 High efficacy 2216 Plus LED inside, Uniform luminescence, Spotless.
 Bendable at horizontal direction.
 Two-color extrusion process, 3M tape, true outdoor application.

10x5mm 12W

Two-color extrusion process



Free Cut

Mini Cut

Product NO.	FEN12W-P7-G1 22X9x 24V300S1 1005L05	FEN12W-P7-G1 22X9x 24V288S8 1005L05
Voltage	DC24V	DC24V
Power	12W/M 3.66W/ft	12W/M 3.66W/ft
CRI	90	90
Led Qty	300LEDs/M 91LEDs/ft	288LEDs/M 88LEDs/ft
Cutting Length	Free Cut (20mm 0.79" Soldering pad distance)	27.77mm 1.09"
IP Grade	IP67	IP67
Length/Reel	5050mm 16.56ft	5050mm 16.56ft
Lumens		
● 2700K	780lm/m 238lm/ft	1210lm/m 369lm/ft
● 3000K	825lm/m 252lm/ft	1245lm/m 380lm/ft
● 4000K	885lm/m 270lm/ft	1280lm/m 390lm/ft
○ 6000K	885lm/m 270lm/ft	1280lm/m 390lm/ft

Note: 'x' (CCT) = "27"(2700K) / "30"(3000K) / "40"(4000K) / "50"(5000K) / "60"(6000K). Please contact us for more information.

Dimension

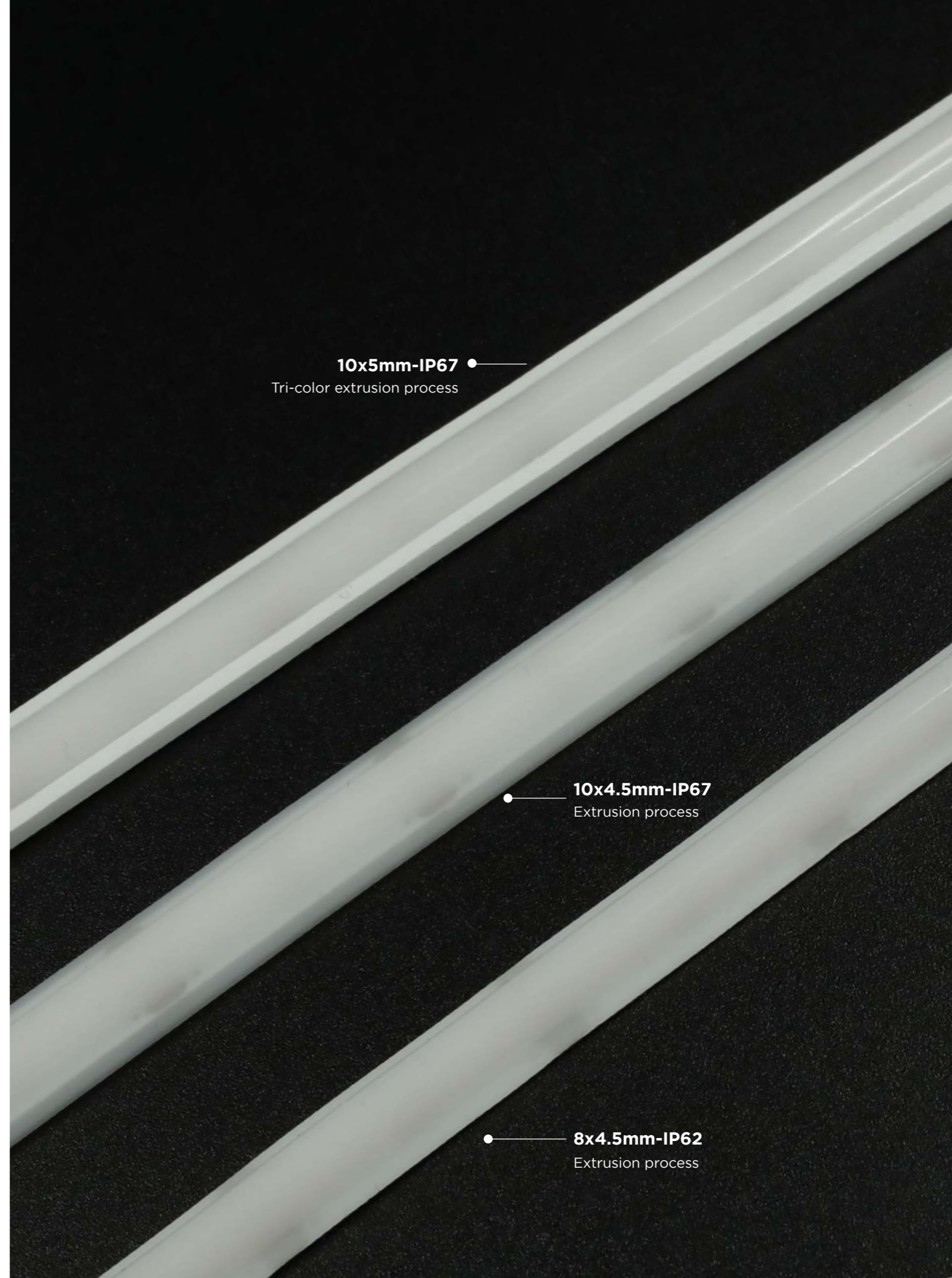
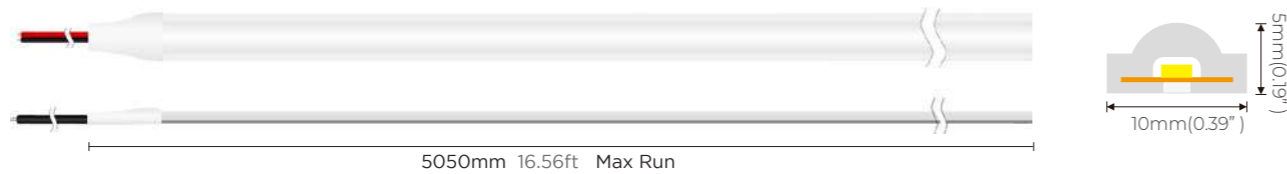

10x5mm-IP67
 Tri-color extrusion process

10x4.5mm-IP67
 Extrusion process

8x4.5mm-IP62
 Extrusion process



2700K 3000K 4000K 5000K 6000K

10x4mm White 10W



Product NO.	FEN10W-P7-G1 COB9x 24V480S 1004L05	Lumens
Voltage	DC24V	● 2700K 750lm/m 229lm/ft
Power	10W/M 3.04W/ft	● 3000K 780lm/m 238lm/ft
CRI	90	● 4000K 860lm/m 262lm/ft
Led Qty	480LEDs/M 146LEDs/ft	○ 6000K 860lm/m 262lm/ft
Cutting Length	50mm 1.97"	
IP Grade	IP67	
Length/Reel	5050mm 16.56ft	

Note: 'x' (CCT) = "27"(2700K) / "30"(3000K) / "40"(4000K) / "50"(5000K) / "60"(6000K). Please contact us for more information.

Dimension

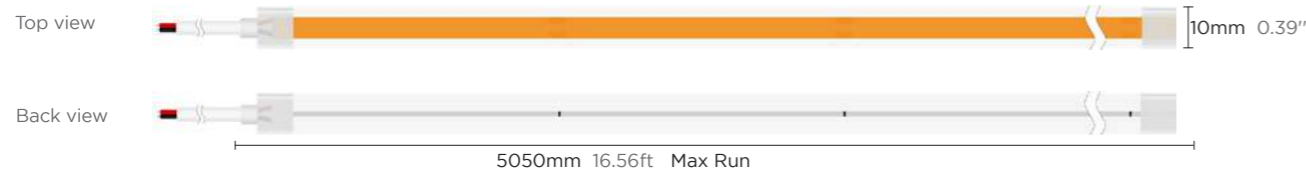

Accessories



* Please contact our sales for the latest details and certifications



10x4mm 10W



Product NO.	FEN10M-P7-G1 COBR 24V480S 1004L05	FEN10M-P7-G1 COBB 24V480S 1004L05
Voltage	DC24V	DC24V
Power	10W/M 3.04W/ft	10W/M 3.04W/ft
CRI	90	90
Led Qty	480LEDs/M 146LEDs/ft	480LEDs/M 146LEDs/ft
Cutting Length	50mm 1.97"	50mm 1.97"
IP Grade	IP67	IP67
Length/Reel	5050mm 16.56ft	5050mm 16.56ft
Lumens	● Red 104lm/m 32lm/ft	● Blue 109lm/m 33lm/ft

Note: 'x' (CCT) = "27"(2700K) / "30"(3000K) / "40"(4000K) / "50"(5000K) / "60"(6000K). Please contact us for more information.

Dimension

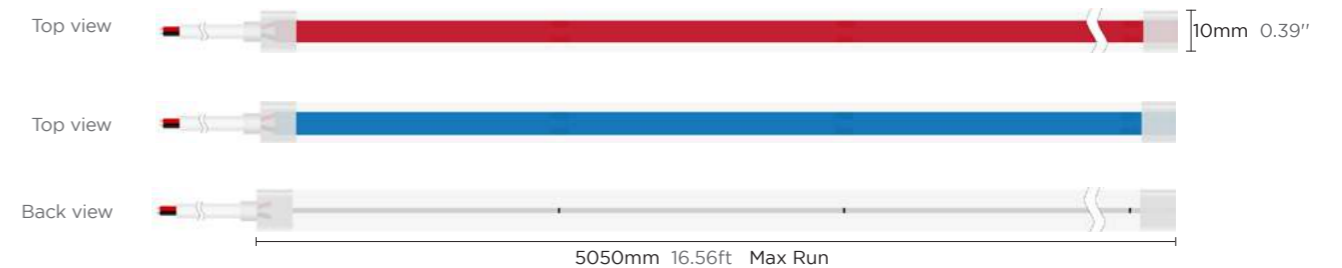

Accessories



* Please contact our sales for the latest details and certifications

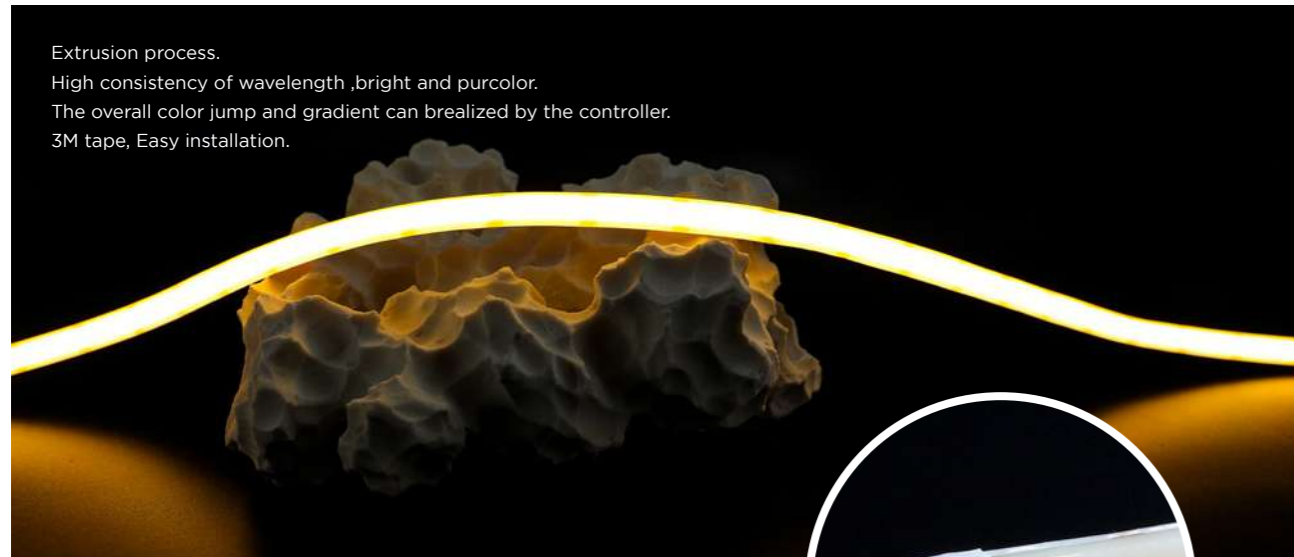

10x5.5mm 14W Tunable CCT

Extrusion process



Product NO.	FEN14C-P2-G2 COB92757 24V608S 1055L05
Voltage	DC24V
Power	14W/M 4.27W/ft
CRI	90
Led Qty	608LEDs/M 185LEDs/ft
Cutting Length	26.3mm 1.04"
IP Grade	IP62
Length/Reel	5050mm 16.56ft
Lumens	
● 2700K	550lm/m 168lm/ft
○ 5700K	720lm/m 220lm/ft

Note:'x' (CCT) = "27"(2700K) / "30"(3000K) / "40"(4000K) / "50"(5000K) / "60"(6000K), Please contact us for more information.

Dimension

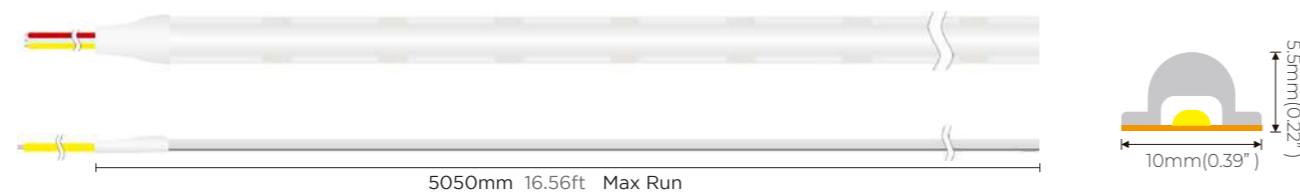

5050mm 16.56ft Max Run



10x5.5mm 14W RGB

Extrusion process



Product NO.	FEN14C-P2-G2 COBRGB 24V840S 1055L05
Voltage	DC24V
Power	14W/M 4.27W/ft
CRI	90
Led Qty	840LEDs/M 256LEDs/ft
Cutting Length	25mm 0.98"
IP Grade	IP62
Length/Reel	5050mm 16.56ft
Lumens	
● R	160lm/m 49lm/ft
● G	375lm/m 114lm/ft
● B	59lm/m 18lm/ft

Note:'x' (CCT) = "27"(2700K) / "30"(3000K) / "40"(4000K) / "50"(5000K) / "60"(6000K), Please contact us for more information.

Dimension

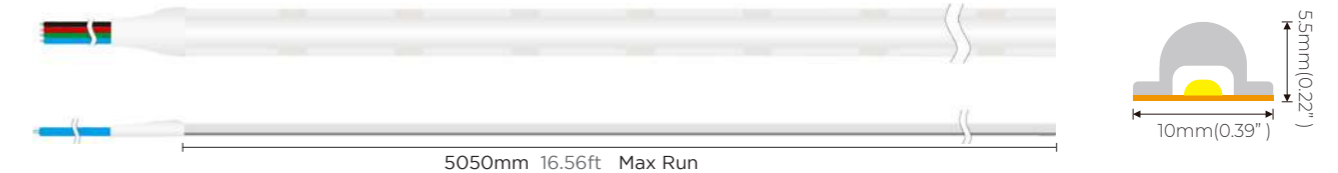

5050mm 16.56ft Max Run



12x6mm 14W Tunable CCT

Extrusion process



Product NO.	FEN14C-P7-G2 COB92594824V608S 1206L05
Voltage	DC24V
Power	14W/M 4.27W/ft
CRI	90
Led Qty	608LEDs/M 185LEDs/ft
Cutting Length	26.3mm 1.03"
IP Grade	IP67
Length/Reel	5050mm 16.56ft
Lumens	
● 2700K	490lm/m 149lm/ft
○ 5700K	650lm/m 198lm/ft

Note:'x' (CCT) = "27"(2700K) / "30"(3000K) / "40"(4000K) / "50"(5000K) / "60"(6000K), Please contact us for more information.

Dimension

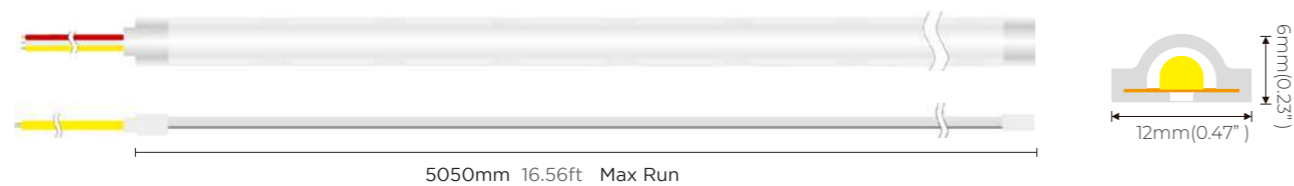

5050mm 16.56ft Max Run



12x6mm 14W RGB

Extrusion process



Product NO.	FEN14C-P7-G2 COBRGB 24V840S 1206L05
Voltage	DC24V
Power	14W/M 4.27W/ft
CRI	90
Led Qty	840LEDs/M 256LEDs/ft
Cutting Length	25mm 0.98"
IP Grade	IP67
Length/Reel	5050mm 16.56ft
Lumens	
● R	100lm/m 30lm/ft
● G	277lm/m 84lm/ft
● B	36lm/m 11lm/ft

Note:'x' (CCT) = "27"(2700K) / "30"(3000K) / "40"(4000K) / "50"(5000K) / "60"(6000K), Please contact us for more information.

Dimension

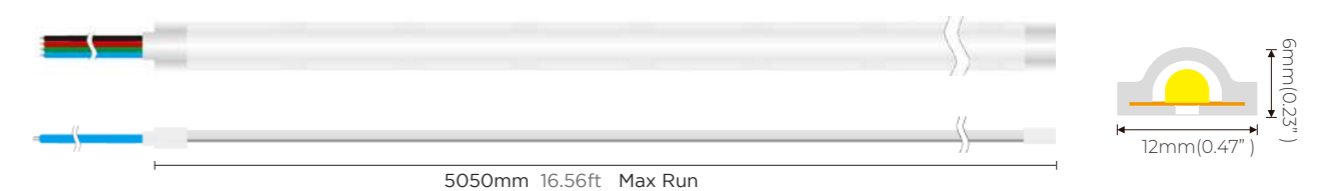

5050mm 16.56ft Max Run

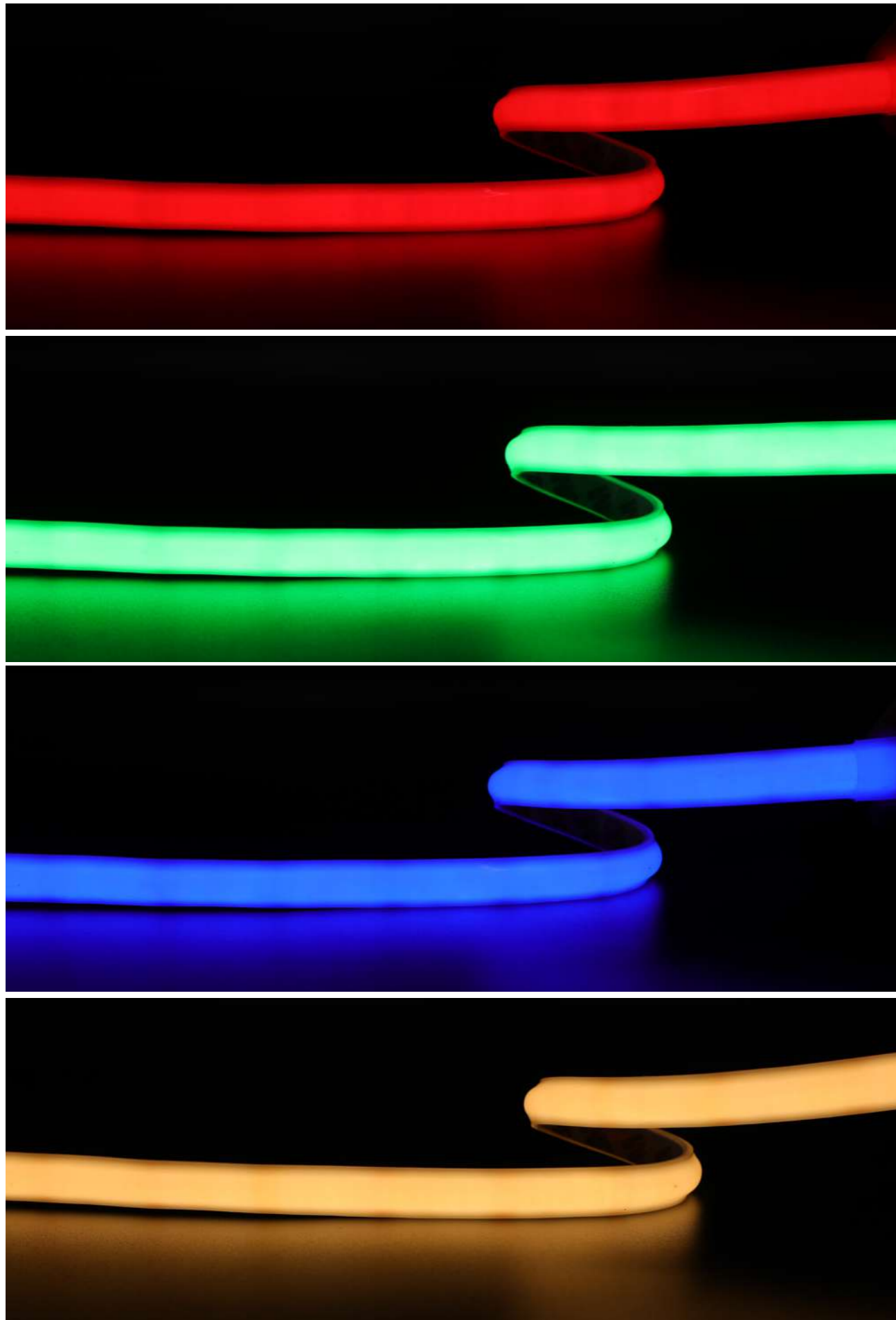

14x6mm 14W RGBW

Extrusion process



Product NO.	FEN18C-P7-G2 COBRGBW 24V840S 1406L05
Voltage	DC24V
Power	18W/M 5.48W/ft
CRI	90
Led Qty	840LEDs/M 256LEDs/ft
Cutting Length	33.33mm 1.31"
IP Grade	IP67
Length/Reel	5050mm 16.56ft
Lumens	
● R	100lm/m 30lm/ft
● G	320lm/m 9lm/ft
● B	44lm/m 13lm/ft
● 2700K	300lm/m 91lm/ft

Note: 'x' (CCT) = "27"(2700K) / "30"(3000K) / "40"(4000K) / "50"(5000K) / "60"(6000K), Please contact us for more information.

Dimension

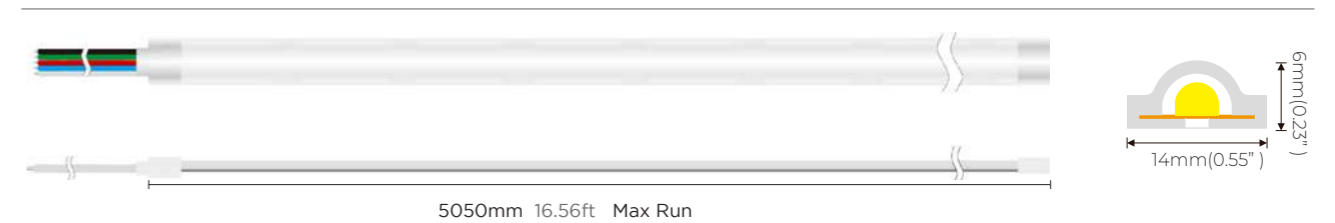

2835 Reel to Reel Series

No soldering joints, No risk of false soldering and weak soldering, easy to cut.
50m/reel,100m/reel in package are available.
Accurate size without deviation.

LED STRIP SERIES · ROLL TO ROLL SERIES

LED STRIP SERIES · ROLL TO ROLL SERIES



2835 Reel to Reel Series

60LEDs / 5M 10M

More stable as no soldering joints
High efficacy up to 95lm/W
High CRI 90,SDCM 3 available



LED STRIP SERIES · ROLL TO ROLL SERIES

More stable without soldering joints.



60LEDs/5M

Product NO.
FE05W-P0-G1 28LX9X 24V60S W08RL05

Technical Details

Power	4.8W/M 1.46W/ft
Voltage	DC24V
CRI	90
Led Qty	60LEDs/M 18LEDs/ft
Length/Reel	5M 16.41ft
Cutting Length	100mm 3.93"
PCB	8mm 0.31"
IP Grade	IP20

Lumens			ErP Class
● 2700K	425lm/m	130lm/ft	G
● 3000K	450lm/m	137lm/ft	F
● 4000K	460lm/m	140lm/ft	F
● 5000K	460lm/m	140lm/ft	F
● 6500K	460lm/m	140lm/ft	F

Note: 'x' (CCT) = "27"(2700K) / "30"(3000K) / "40"(4000K) / "50"(5000K) / "60"(6000K), Please contact us for more information.
* Please contact our sales for the latest details and certifications

60LEDs/10M

Product NO.
FE05W-P0-G1 28LX9X 24V60S W08RL10

Technical Details

Power	4.8W/M 1.46W/ft
Voltage	DC24V
CRI	90
Led Qty	60LEDs/M 18LEDs/ft
Length/Reel	10M 32.8ft
Cutting Length	100mm 3.93"
PCB	8mm 0.31"
IP Grade	IP20

Lumens			ErP Class
● 2700K	425lm/m	130lm/ft	G
● 3000K	450lm/m	137lm/ft	F
● 4000K	460lm/m	140lm/ft	F
● 5000K	460lm/m	140lm/ft	F
● 6500K	460lm/m	140lm/ft	F

Dimension

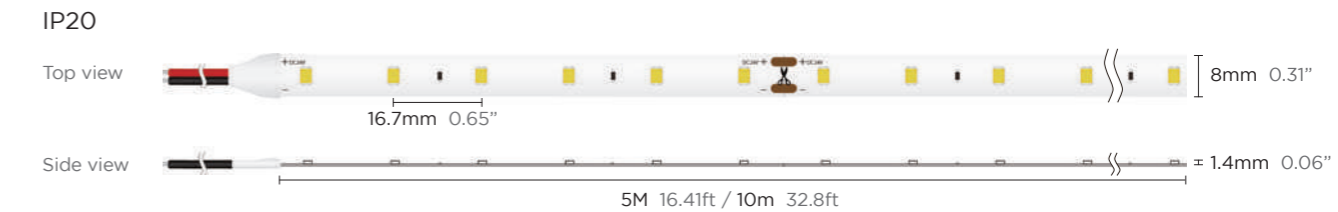

Connectors List

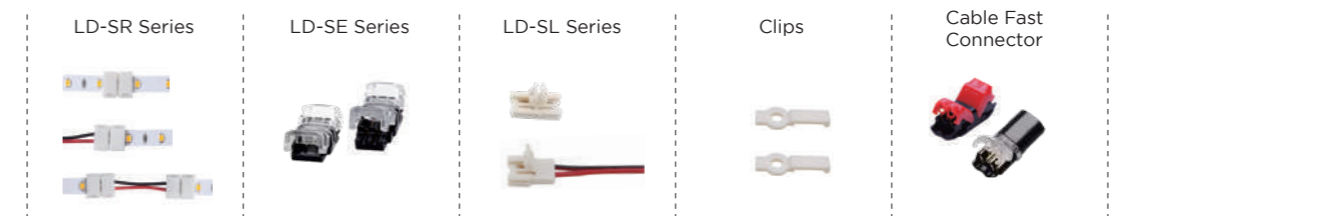

* Please Go to page 248 for Accessory and Connector Usage Guidelines.

LED STRIP SERIES · ROLL TO ROLL SERIES

2835 Reel to Reel Series

120LEDs / 5M 10M

More stable as no soldering joints
 High efficacy, up to 95lm/W
 High CRI 90, SDCM<3 available



LED STRIP SERIES · 2835 REEL TO REEL SERIES

More stable without soldering joints.



120LEDs/5M

Product NO.
 FE10W-P0-G1 28LX9X 24V120S W08RL05

Technical Details

Power	9.6W/M 2.93W/ft
Voltage	DC24V
CRI	90
Led Qty	120LEDs/M 36LEDs/ft
Length/Reel	5M 16.41ft
Cutting Length	50mm 1.97"
PCB	8mm 0.31"
IP Grade	IP20

Lumens			ErP Class
● 2700K	855lm/m 261lm/ft		G
● 3000K	910lm/m 277lm/ft		F
● 4000K	920lm/m 280lm/ft		F
● 5000K	920lm/m 280lm/ft		F
● 6500K	920lm/m 280lm/ft		F

Note: 'x' (CCT) = "27"(2700K) / "30"(3000K) / "40"(4000K) / "50"(5000K) / "60"(6000K), Please contact us for more information.
 * Please contact our sales for the latest details and certifications

120LEDs/10M

Product NO.
 FE10W-P0-G1 28LX9X 24V120S W10RL10

Technical Details

Power	9.6W/M 2.93W/ft
Voltage	DC24V
CRI	90
Led Qty	120LEDs/M 36LEDs/ft
Length/Reel	10M 32.8ft
Cutting Length	50mm 1.97"
PCB	10mm 0.39"
IP Grade	IP20

Lumens			ErP Class
● 2700K	855lm/m 261lm/ft		G
● 3000K	910lm/m 277lm/ft		F
● 4000K	920lm/m 280lm/ft		F
● 5000K	920lm/m 280lm/ft		F
● 6500K	920lm/m 280lm/ft		F

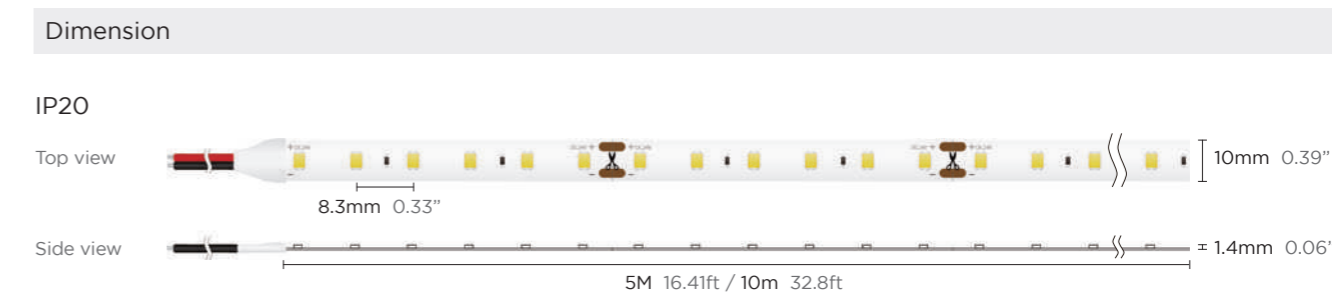

Connectors List

LD-SR Series 	LD-SE Series 	LD-SL Series 	Clips 	Cable Fast Connector
-------------------------	-------------------------	-------------------------	------------------	---------------------------------

* Please Go to page 248 for Accessory and Connector Usage Guidelines.

LED STRIP SERIES · 2835 REEL TO REEL SERIES

2835 Reel to Reel Series

70LEDs / 140LEDs / 5M

More stable as no soldering joints
 High efficacy, up to 122lm/W
 High CRI 90, SDCM<3 available



More stable without soldering joints.



70LEDs/5M

Product NO.

FE05W-P0-G1 28HX9X 24V70S W10RL05

Technical Details

Power	4.8W/M 1.46W/ft
Voltage	DC24V
CRI	90
Led Qty	70LEDs/M 21LEDs/ft
Length/Reel	5M 16.41ft
Cutting Length	100mm 3.94"
PCB	10mm 0.39"
IP Grade	IP20

Lumens

● 2700K	530lm/m	161lm/ft
● 3000K	560lm/m	170lm/ft
● 4000K	600lm/m	183lm/ft
● 5000K	580lm/m	177lm/ft
● 6500K	580lm/m	177lm/ft

Note: 'x' (CCT) = "27"(2700K) / "30"(3000K) / "40"(4000K) / "50"(5000K) / "60"(6000K), Please contact us for more information.

* Please contact our sales for the latest details and certifications

140LEDs/5M

Product NO.

FE10W-P0-G1 28HX9X 24V140S W10RL05

Technical Details

Power	9.6W/M 2.93W/ft
Voltage	DC24V
CRI	90
Led Qty	140LEDs/M 42LEDs/ft
Length/Reel	5M 16.41ft
Cutting Length	50mm 1.97"
PCB	10mm 0.39"
IP Grade	IP20

Lumens

● 2700K	1050lm/m	320lm/ft
● 3000K	1100lm/m	335lm/ft
● 4000K	1180lm/m	360lm/ft
● 5000K	1100lm/m	335lm/ft
● 6500K	1100lm/m	335lm/ft

Dimension

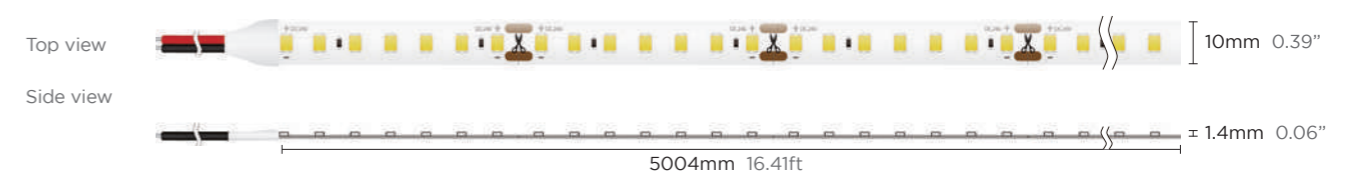

Connectors List



* Please Go to page 248 for Accessory and Connector Usage Guidelines.

2835 Reel to Reel Series

80LEDs / 160LEDs / 5M

More stable as no soldering joints
 High efficacy, up to 132lm/W
 High CRI 90, SDCM<3 available



More stable without soldering joints.



Connectors List



* Please Go to page 248 for Accessory and Connector Usage Guidelines.

80LEDs/5M

Product NO. FH07W-P0-G1 28HX9X 24V80S8 W08RL05

Power	7.2W/M 2.2W/ft	Lumens		
Voltage	DC24V	● 2700K	915lm/m	279lm/ft
CRI	90	● 3000K	935lm/m	285lm/ft
Led Qty	80LEDs/M 24LEDs/ft	● 4000K	955lm/m	291lm/ft
Length/Reel	5M 16.41ft	● 5000K	955lm/m	291lm/ft
IP Grade	IP20	● 6500K	955lm/m	291lm/ft

80LEDs/5M

Product NO. FH10W-P0-G1 28HX9X 24V80S8 W10RL05

Power	9.6W/M 2.93W/ft	Lumens		
Voltage	DC24V	● 2700K	1215lm/m	370lm/ft
CRI	90	● 3000K	1245lm/m	380lm/ft
Led Qty	80LEDs/M 24LEDs/ft	● 4000K	1270lm/m	387lm/ft
Length/Reel	5M 16.41ft	● 5000K	1270lm/m	387lm/ft
IP Grade	IP20	● 6500K	1270lm/m	387lm/ft

160LEDs/5M

Product NO. FH14W-P0-G1 28HX9X24V160S8 W10RL05

Power	14.4W/M 4.39W/ft	Lumens		
Voltage	DC24V	● 2700K	1825lm/m	556lm/ft
CRI	90	● 3000K	1870lm/m	570lm/ft
Led Qty	160LEDs/M 49LEDs/ft	● 4000K	1915lm/m	583lm/ft
Length/Reel	5M 16.41ft	● 5000K	1915lm/m	583lm/ft
IP Grade	IP20	● 6500K	1915lm/m	583lm/ft

Note: 'x' (CCT) = "27"(2700K) / "30"(3000K) / "40"(4000K) / "50"(5000K) / "60"(6000K), Please contact us for more information.

* Please contact our sales for the latest details and certifications

Dimension

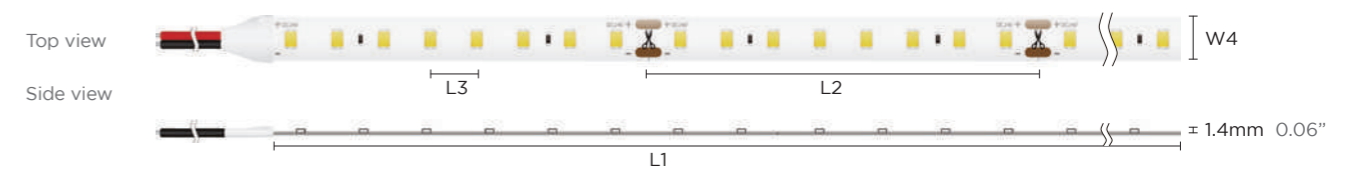

	L1	L2	L3	W4
FH07W-P0-G1 28HX9X 24V80S8 W08RL05	5m 16.41ft	100mm 3.94"	12.5mm 0.49"	8mm 0.31"
FH10W-P0-G1 28HX9X 24V80S8 W10RL05	5m 16.41ft	100mm 3.94"	12.5mm 0.49"	10mm 0.39"
FH14W-P0-G1 28HX9X24V160S8 W10RL05	5m 16.41ft	50mm 1.97"	6.28mm 0.24"	10mm 0.39"



Ultra-Long Series

24V Ultra-Long Series —

Single end power feed carries
up to 100M.

24V Constant Current Series —

Single end power feed carries
up to 25M.

48V Ultra-Long Series —

Single end power feed carries
up to 50M.

110-220V High Voltage Ultra-Long Series —

Single end power feed carries
up to 50M.

24V Ultra-Long Series

UP TO 100M

Low voltage 24V ensures working safety. The single-ended input can reach to 100M, which solves many installation problems, such as the pre-buried position of the power supply.

Copper strand structure design, more sturdy.



LED STRIP SERIES · ULTRA-LONG SERIES

LED STRIP SERIES · ULTRA-LONG SERIES

10M Product NO. FP14W-P5-G2 28HZ9x 24VT70S7 1307L10

Power	14.4W/M 4.39W/ft	Lumens	
Voltage	DC24V	● 2700K	1370lm/m 417lm/ft
CRI	90	● 3000K	1410lm/m 430lm/ft
Led Qty	70LEDs/m 21LEDs/ft	● 4000K	1470lm/m 448lm/ft
Length/Reel	10M 32.8ft	● 5000K	1425lm/m 434lm/ft
Cutting Length	100mm 3.93"	● 6000K	1425lm/m 434lm/ft

20M Product NO. FP10W-P5-G2 28HZ9x 24VT70S7 1307L20

Power	9.6W/M 2.93W/ft	Lumens	
Voltage	DC24V	● 2700K	970lm/m 295lm/ft
CRI	90	● 3000K	995lm/m 303lm/ft
Led Qty	70LEDs/m 21LEDs/ft	● 4000K	1050lm/m 320lm/ft
Length/Reel	20M 65.62ft	● 5000K	1010lm/m 307lm/ft
Cutting Length	100mm 3.93"	● 6000K	1010lm/m 307lm/ft

20M Product NO. FP16W-P5-G2 28HZ9x 24VT140S7 1307L20

Power	16W/M 4.87W/ft	Lumens	
Voltage	DC24V	● 2700K	1650lm/m 503lm/ft
CRI	90	● 3000K	1740lm/m 530lm/ft
Led Qty	140LEDs/m 42LEDs/ft	● 4000K	1825lm/m 556lm/ft
Length/Reel	20M 65.62ft	● 5000K	1780lm/m 542lm/ft
Cutting Length	50mm 1.94"	● 6000K	1780lm/m 542lm/ft

30M Product NO. FP08W-P5-G2 28HZ9x 24VT140S7 1307L30

Power	8W/M 2.43W/ft	Lumens	
Voltage	DC24V	● 2700K	865lm/m 264lm/ft
CRI	90	● 3000K	910lm/m 277lm/ft
Led Qty	140LEDs/m 42LEDs/ft	● 4000K	955lm/m 291lm/ft
Length/Reel	30M 65.62ft	● 5000K	925lm/m 282lm/ft
Cutting Length	50mm 1.94"	● 6000K	925lm/m 282lm/ft

40M Product NO. FP05W-P5-G2 28HZ9x 24VT70S7 1307L40

Power	4.8W/M 1.46W/ft	Lumens	
Voltage	DC24V	● 2700K	510lm/m 155lm/ft
CRI	90	● 3000K	525lm/m 160lm/ft
Led Qty	70LEDs/m 21LEDs/ft	● 4000K	550lm/m 167lm/ft
Length/Reel	40M 131ft	● 5000K	535lm/m 163lm/ft
Cutting Length	100mm 3.93"	● 6000K	535lm/m 163lm/ft

100M Product NO. FP02W-P5-G2 28LZ9x 24VT70S7 1307L100

Power	2W/M 0.61W/ft	Lumens	
Voltage	DC24V	● 2700K	205lm/m 62lm/ft
CRI	90	● 3000K	215lm/m 65lm/ft
Led Qty	70LEDs/m 21LEDs/ft	● 4000K	230lm/m 70lm/ft
Length/Reel	100M 131ft	● 5000K	225lm/m 68lm/ft
Cutting Length	100mm 3.93"	● 6000K	225lm/m 68lm/ft

Note: 'x' (CCT) = "27"(2700K) / "30"(3000K) / "40"(4000K) / "50"(5000K) / "60"(6000K), Please contact us for more information.

* Please contact our sales for the latest details and certifications

Dimension

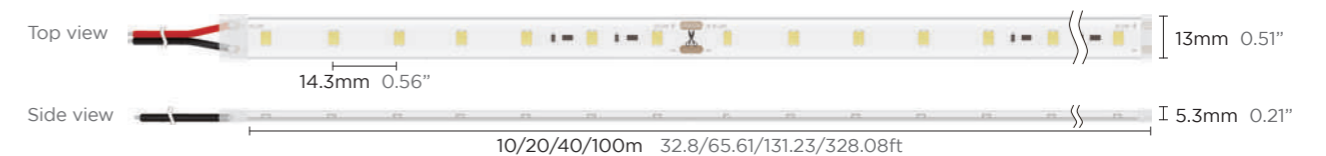

* Please Go to page 108 for Accessory and Connector Usage Guidelines.

24V Ultra-Long Series

120LEDs/M IP20



20M

Product NO. FP09W-P0-G1 28QG9x 24VT120S W10L20

Power	8.5W/M 2.59W/ft	Lumens		
Voltage	DC24V	● 2700K	739lm/m	225lm/ft
CRI	90	● 3000K	768lm/m	234lm/ft
Led Qty	120LEDs/M 36LEDs/ft	● 4000K	850lm/m	259lm/ft
Length/Reel	20M 65.61ft	● 5000K	820lm/m	250lm/ft
Cutting Length	50mm 1.97"	● 6000K	795lm/m	242lm/ft
IP Grade	IP20			

Note: 'x' (CCT) = "27"(2700K) / "30"(3000K) / "40"(4000K) / "50"(5000K) / "60"(6000K), Please contact us for more information.

* Please contact our sales for the latest details and certifications

Dimension



Connectors List



* Please Go to page 248 for Accessory and Connector Usage Guidelines.

140LEDs/M IP65



10M

Product NO. FP20W-P5-G1 28AS9X 24VT140S W10L10 NILED

Power	20W/M 6.1W/ft	Lumens		
Voltage	DC24V	● 2700K	2040lm/m	622lm/ft
CRI	90	● 3000K	2100lm/m	640lm/ft
Led Qty	140LEDs/M 42LEDs/ft	● 4000K	2240lm/m	683lm/ft
Length/Reel	10M 32.8ft	● 5000K	2240lm/m	683lm/ft
Cutting Length	50mm 1.97"	● 6500K	2240lm/m	683lm/ft
IP Grade	IP65			

15M

Product NO. FP15W-P5-G1 28AS9X 24VT140S W10L15 NILED

Power	15W/M 4.6W/ft	Lumens		
Voltage	DC24V	● 2700K	1530lm/m	466lm/ft
CRI	90	● 3000K	1590lm/m	485lm/ft
Led Qty	140LEDs/M 42LEDs/ft	● 4000K	1680lm/m	512lm/ft
Length/Reel	15M 49.21ft	● 5000K	1680lm/m	512lm/ft
Cutting Length	50mm 1.97"	● 6500K	1680lm/m	512lm/ft
IP Grade	IP65			

20M

Product NO. FP10W-P5-G1 28AS9X 24VT140S W10L20 NILED

Power	10W/M 1.46W/ft	Lumens		
Voltage	DC24V	● 2700K	1000lm/m	305lm/ft
CRI	90	● 3000K	1050lm/m	320lm/ft
Led Qty	140LEDs/M 42LEDs/ft	● 4000K	1110lm/m	338lm/ft
Length/Reel	20M 65.61ft	● 5000K	1110lm/m	338lm/ft
Cutting Length	50mm 1.97"	● 6500K	1110lm/m	338lm/ft
IP Grade	IP65			

Dimension

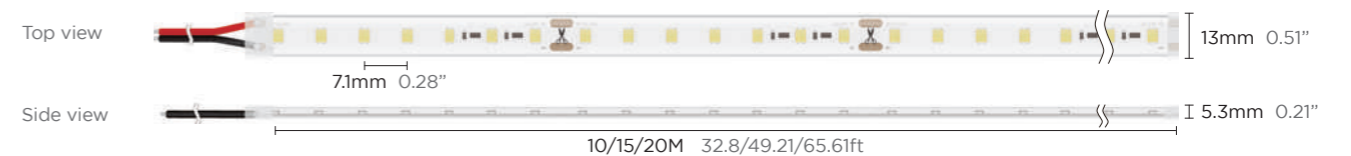

24V Ultra-Long Constant Current Series

Under constant current condition, brightness output is more stable, life is longer.

Up to 25m

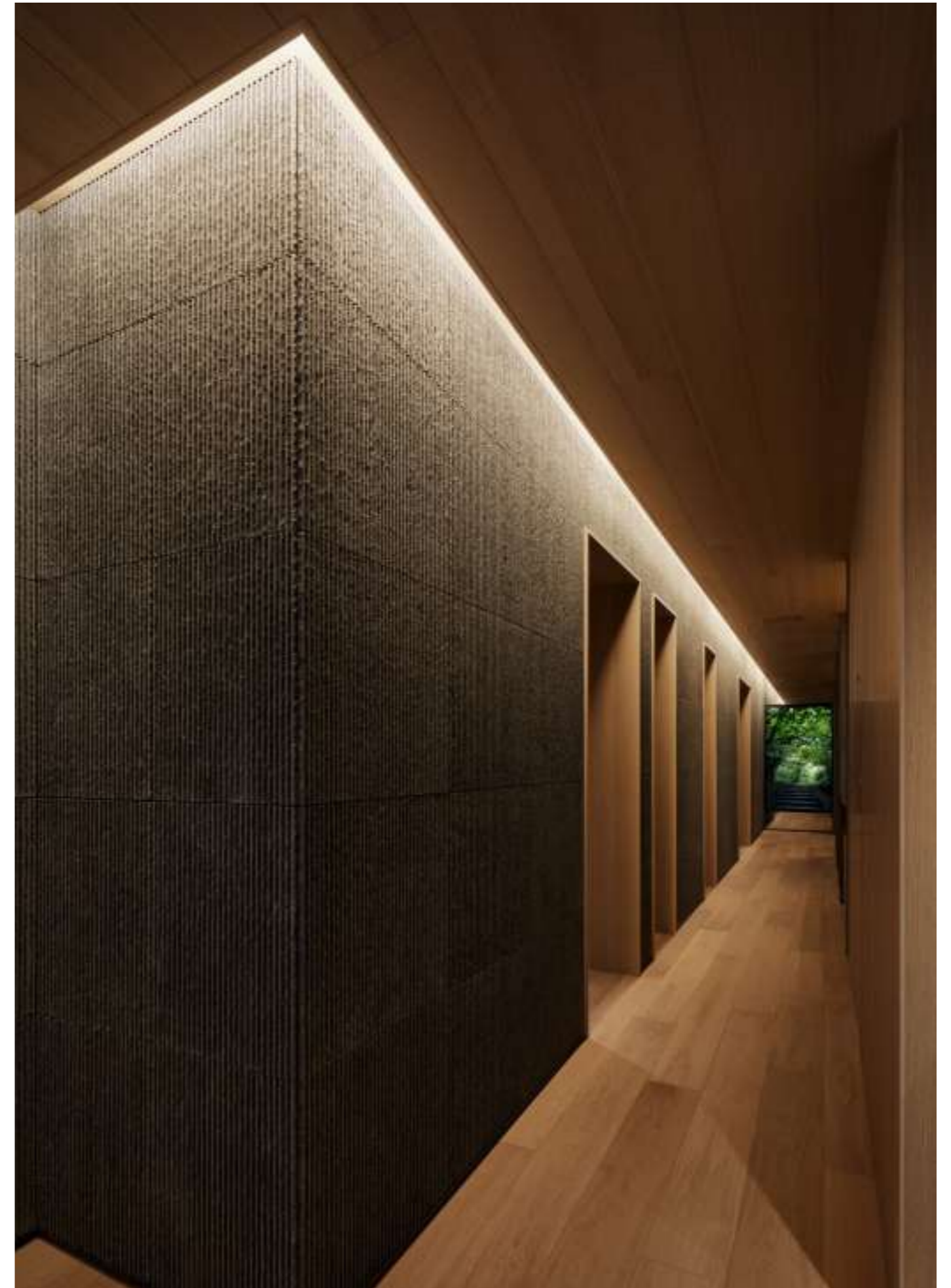

24V Ultra-Long Constant Current Series

6 LEDs/Group 15M-25M

Under constant current condition, brightness output is more stable, life is longer.
Ultra-long strip driven by one end power supply.
The same brightness from end to end.



LED STRIP SERIES · ULTRA-LONG SERIES

LED STRIP SERIES · ULTRA-LONG SERIES

Connectors List

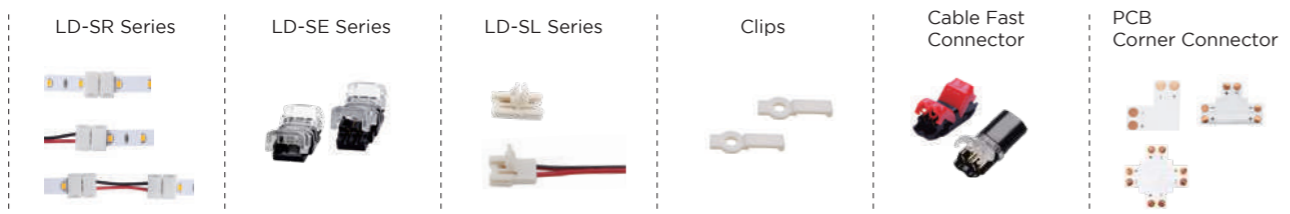

* Please Go to page 248 for Accessory and Connector Usage Guidelines.

60LEDs/M 4.8W/ 25M

Product NO. FH05W-PO-G1 28HX9X 24VT60S W10L25

Power	4.8W/M 1.46W/ft	Lumens		
Voltage	DC24V	● 2700K	390lm/m	119lm/ft
CRI	90	● 3000K	410lm/m	125lm/ft
Led Qty	60LEDs/M 18LEDs/ft	● 4000K	430lm/m	131lm/ft
Length/Reel	25M 82.02ft	● 5000K	420lm/m	128lm/ft
Cutting Length	100mm 3.93"	● 6500K	420lm/m	128lm/ft
IP Grade	IP20			

120LEDs/M 8.5W/ 20M

Product NO. FH09W-PO-G1 28HX9X 24VT120S W10L20

Power	8.5W/M 2.6W/ft	Lumens		
Voltage	DC24V	● 2700K	680lm/m	207lm/ft
CRI	90	● 3000K	705lm/m	215lm/ft
Led Qty	120LEDs/M 36LEDs/ft	● 4000K	750lm/m	229lm/ft
Length/Reel	20M 65.61ft	● 5000K	720lm/m	220lm/ft
Cutting Length	50mm 1.97"	● 6500K	720lm/m	220lm/ft
IP Grade	IP20			

120LEDs/M 9.6W/ 15M

Product NO. FH10W-PO-G1 28HX9X 24VT120S W10L15

Power	9.6W/M 2.93W/ft	Lumens		
Voltage	DC24V	● 2700K	770lm/m	235lm/ft
CRI	90	● 3000K	800lm/m	244lm/ft
Led Qty	120LEDs/M 36LEDs/ft	● 4000K	840lm/m	256lm/ft
Length/Reel	15M 49.21ft	● 5000K	820lm/m	250lm/ft
Cutting Length	50mm 1.97"	● 6500K	820lm/m	250lm/ft
IP Grade	IP20			

Dimension

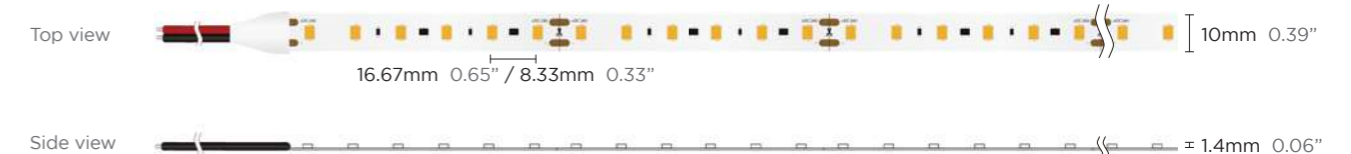

24V Ultra-Long Constant Current Series

1M-20M, Lumen Different : 0.25%

(Tested Sample: 20M 4.8W/M)

Under constant current condition, brightness output is more stable, life is longer.
20m Ultra-long strip driven by one end power supply.
The same brightness from end to end.



LED STRIP SERIES · ULTRA-LONG SERIES

70LEDs/M 20M

IP20

Product NO. FH05W-P0-G1 28HX9X 24VC70S7 W10L20

Power	4.8W/M 1.46W/ft	Lumens		
Voltage	DC24V	● 2700K	545lm/m	166lm/ft
CRI	90	● 3000K	575lm/m	175lm/ft
Led Qty	70LEDs/M 21LEDs/ft	● 4000K	595lm/m	181lm/ft
Length/Reel	20M 65.61ft	● 5000K	595lm/m	181lm/ft
Cutting Length	100mm 3.93"	● 6500K	595lm/m	181lm/ft
IP Grade	IP20			

IP65

Product NO. FH05W-P5-G1 28HX9X 24VC70S7 W10L20

Power	4.8W/M 1.46W/ft	Lumens		
Voltage	DC24V	● 2700K	530lm/m	162lm/ft
CRI	90	● 3000K	555lm/m	169lm/ft
Led Qty	70LEDs/M 21LEDs/ft	● 4000K	580lm/m	177lm/ft
Length/Reel	20M 65.61ft	● 5000K	580lm/m	177lm/ft
Cutting Length	100mm 3.93"	● 6500K	580lm/m	177lm/ft
IP Grade	IP65			

Dimension

IP20

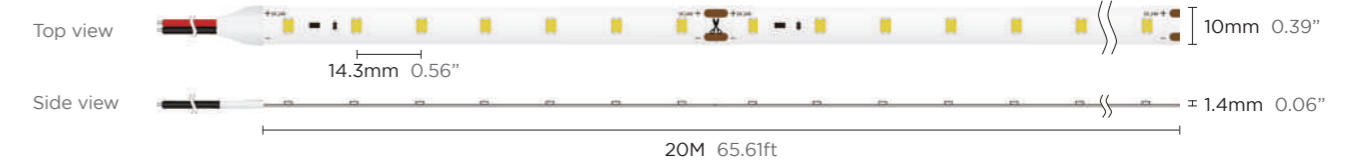

IP65

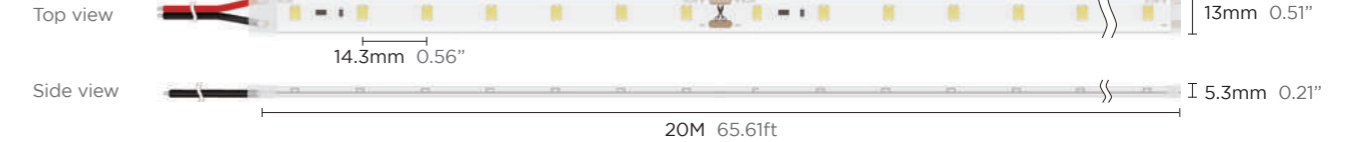

Connectors List



* Please Go to page 248 for Accessory and Connector Usage Guidelines.

LED STRIP SERIES · ULTRA-LONG SERIES

24V Ultra-Long Constant Current Series

1M-20M, Lumen Different : 0.25%

(Tested Sample: 20M 4.8W/M)

Under constant current condition, brightness output is more stable, life is longer.
10m Ultra-long strip driven by one end power supply.
The same brightness from end to end.



LED STRIP SERIES · ULTRA-LONG SERIES



140LEDs/M 10M

IP20

Product NO. FH10W-P0-G1 28HX9X 24VC140S7 W10L10

Power	9.6W/M 2.93W/ft	Lumens		
Voltage	DC24V	● 2700K	1075lm/m	328lm/ft
CRI	90	● 3000K	1115lm/m	340lm/ft
Led Qty	140LEDs/M 42LEDs/ft	● 4000K	1180lm/m	360lm/ft
Length/Reel	10M 32.8ft	● 5000K	1180lm/m	360lm/ft
Cutting Length	50mm 1.97"	● 6500K	1180lm/m	360lm/ft
IP Grade	IP20			

IP65

Product NO. FH10W-P5-G1 28HX9X 24VC140S7 W10L10

Power	9.6W/M 2.93W/ft	Lumens		
Voltage	DC24V	● 2700K	1055lm/m	322lm/ft
CRI	90	● 3000K	1105lm/m	337lm/ft
Led Qty	140LEDs/M 42LEDs/ft	● 4000K	1150lm/m	351lm/ft
Length/Reel	10M 32.8ft	● 5000K	1150lm/m	351lm/ft
Cutting Length	50mm 1.97"	● 6500K	1150lm/m	351lm/ft
IP Grade	IP65			

Dimension

IP20

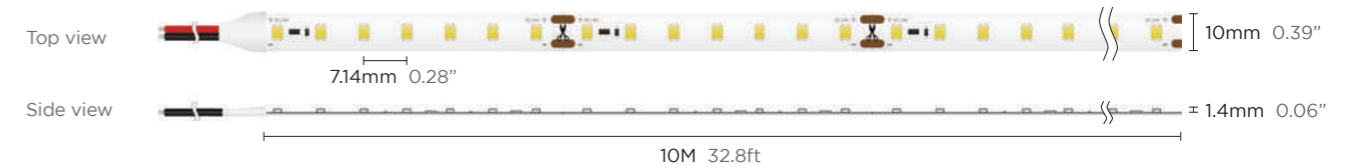

IP65

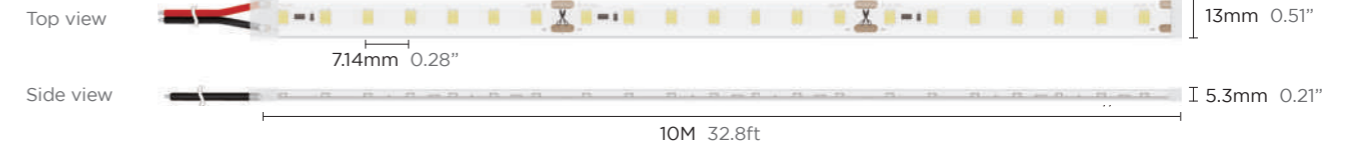

Connectors List



* Please Go to page 248 for Accessory and Connector Usage Guidelines.

LED STRIP SERIES · ULTRA-LONG SERIES

24V Ultra-Long Constant Current Series

7 LEDs/Group 10M-20M

Under constant current condition, brightness output is more stable, life is longer.
20m Ultra-long Strip Driven by one end power supply.
The same brightness from end to end.



LED STRIP SERIES · ULTRA-LONG SERIES

70LEDs/M 20M

Product NO. FH05W-P0-G1 28HX9X 24VT70S7 W10L20

Power	4.8W/M 1.46W/ft	Lumens		
Voltage	DC24V	● 2700K	455lm/m	139lm/ft
CRI	90	● 3000K	480lm/m	146lm/ft
Led Qty	70LEDs/M 21LEDs/ft	● 4000K	510lm/m	155lm/ft
Length/Reel	20M 65.61ft	● 5000K	500lm/m	152lm/ft
Cutting Length	100mm 3.94"	● 6500K	500lm/m	152lm/ft
IP Grade	IP20			

140LEDs/M 10M

Product NO. FH10W-P0-G1 28HX9X 24VT140S7 W10L10

Power	9.6W/M 2.93W/ft	Lumens		
Voltage	DC24V	● 2700K	890lm/m	271lm/ft
CRI	90	● 3000K	940lm/m	287lm/ft
Led Qty	140LEDs/M 42LEDs/ft	● 4000K	1000lm/m	305lm/ft
Length/Reel	10M 32.8ft	● 5000K	980lm/m	299lm/ft
Cutting Length	50mm 1.97"	● 6500K	980lm/m	299lm/ft
IP Grade	IP20			

Dimension

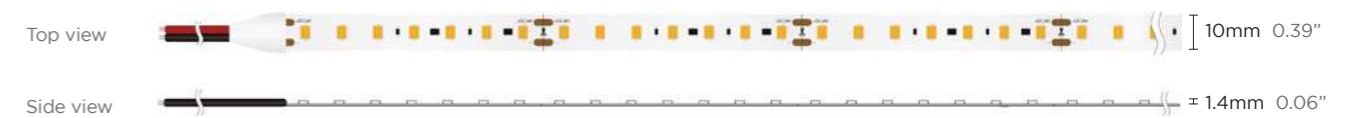

Connectors List



* Please Go to page 248 for Accessory and Connector Usage Guidelines.

LED STRIP SERIES · ULTRA-LONG SERIES

24V Ultra-Long Constant Current Series

8 LEDs/Group 8M-15M

Under constant current condition, brightness output is more stable, life is longer.
15m Ultra-long Strip Driven by one end power supply.
The same brightness from end to end.



Connectors List

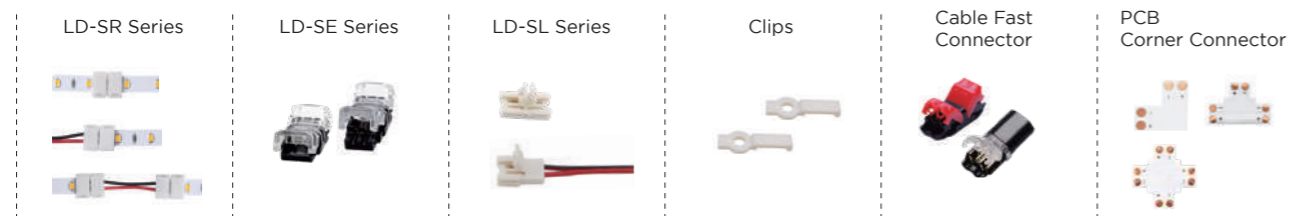

* Please Go to page 248 for Accessory and Connector Usage Guidelines.

80LEDs/M 15M

Product NO. FH05W-PO-G1 28BL9X 24VC80S8 W10L15

Power	4.8W/M 1.46W/ft	Lumens		
Voltage	DC24V	● 2700K	690lm/m	210lm/ft
CRI	90	● 3000K	730lm/m	223lm/ft
Led Qty	80LEDs/M 24LEDs/ft	● 4000K	770lm/m	235lm/ft
Length/Reel	15M 49.21ft	● 5000K	750lm/m	229lm/ft
Cutting Length	100mm 3.94"	● 6500K	750lm/m	229lm/ft
IP Grade	IP20			

160LEDs/M 10M

Product NO. FH10W-PO-G1 28BL9X 24VC160S8 W10L10

Power	9.6W/M 2.93W/ft	Lumens		
Voltage	DC24V	● 2700K	1360lm/m	415lm/ft
CRI	90	● 3000K	1450lm/m	442lm/ft
Led Qty	160LEDs/M 49LEDs/ft	● 4000K	1520lm/m	463lm/ft
Length/Reel	10M 32.8ft	● 5000K	1480lm/m	451lm/ft
Cutting Length	50mm 1.97"	● 6500K	1480lm/m	451lm/ft
IP Grade	IP20			

Dimension



48V Ultra-Long Series

Single end power carries up to 50M.
Uniform brightness from end to end.

Regular
Mini Cut
High Efficiency
Tunable CCT
Mini Size
RGB
RGBW

48V Ultra-Long Series Regular

Single end power carries 50M.
Uniform brightness from end to end.
Up to 106LM/W.
Easy to Install & save time.



Dimension

IP20



IP65



Connectors List

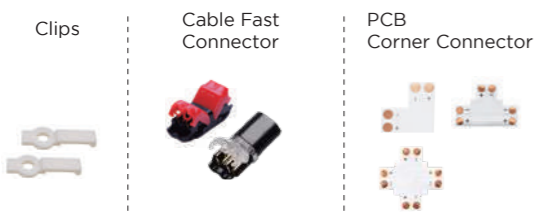

* Please Go to page 248 for Accessory and Connector Usage Guidelines.

40M / 72LEDs / PCB 8MM

IP20/4.8W

Product NO. FH05W-P0-G1 28LZ9X 48VT72S12 W08L40

Power	4.8W/M 1.46W/ft	Lumens		ErP Class	
Voltage	DC48V	2700K	440lm/m 134lm/ft	G	
CRI	90	3000K	480lm/m 146lm/ft	F	
Led Qty	72LEDs/M 21LEDs/ft	4000K	510lm/m 155lm/ft	F	
Cutting Length	166.67mm 6.56"	5000K	510lm/m 155lm/ft	F	
Length/Reel	40m 131.23ft	6500K	510lm/m 155lm/ft	F	
IP Grade	IP20				

IP65/4.8W

Product NO. FH05W-P5-G2 28LZ9X 48VT72S12 W08L40

Power	4.8W/M 1.46W/ft	Lumens		ErP Class	
Voltage	DC48V	2700K	415lm/m 127lm/ft	G	
CRI	90	3000K	435lm/m 133lm/ft	F	
Led Qty	72LEDs/M 21LEDs/ft	4000K	485lm/m 148lm/ft	F	
Cutting Length	166.67mm 6.56"	5000K	485lm/m 148lm/ft	F	
Length/Reel	40m 131.23ft	6500K	485lm/m 148lm/ft	F	
IP Grade	IP65				

50M / 72LEDs / PCB 10MM

IP20/4.8W

Product NO. FH05W-P0-G1 28LZ9X 48VT72S12 W10L50

Power	4.8W/M 1.46W/ft	Lumens		ErP Class	
Voltage	DC48V	2700K	440lm/m 134lm/ft	G	
CRI	90	3000K	455lm/m 139lm/ft	F	
Led Qty	72LEDs/M 21LEDs/ft	4000K	490lm/m 149lm/ft	F	
Cutting Length	166.67mm 6.56"	5000K	490lm/m 149lm/ft	F	
Length/Reel	50m 164.04ft	6500K	490lm/m 149lm/ft	F	
IP Grade	IP20				

IP65/4.8W

Product NO. FH05W-P5-G2 28LZ9X 48VT72S12 W10L50

Power	4.8W/M 1.46W/ft	Lumens		ErP Class	
Voltage	DC48V	2700K	425lm/m 130lm/ft	G	
CRI	90	3000K	455lm/m 139lm/ft	F	
Led Qty	72LEDs/M	4000K	490lm/m 149lm/ft	F	
Cutting Length	166.67mm 6.56"	5000K	490lm/m 149lm/ft	F	
Length/Reel	50m 164.04ft	6500K	490lm/m 149lm/ft	F	
IP Grade	IP65				

Note: 'x' (CCT) = "27"(2700K) / "30"(3000K) / "40"(4000K) / "50"(5000K) / "60"(6000K), Please contact us for more information.

* Please contact our sales for the latest details and certifications

48V Ultra-Long Series Regular

Single end power carries 50M.
Uniform brightness from end to end.
Up to 106LM/W.
Easy to install & save time.



Dimension

IP20



IP65



Connectors List

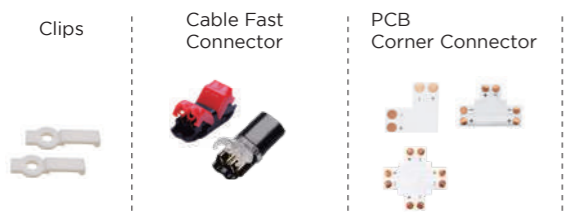

* Please Go to page 248 for Accessory and Connector Usage Guidelines.

40M / 120LEDs / PCB 8MM

IP20/8W

Product NO. FH08W-P0-G1 28LZ9X 48VT120S12 W08L40

Power	8W/M 2.43W/ft	Lumens			ErP Class
Voltage	DC48V	● 2700K	720lm/m	220lm/ft	G
CRI	90	● 3000K	775lm/m	236lm/ft	F
Led Qty	120LEDs/M 36LEDs/ft	● 4000K	850lm/m	259lm/ft	F
Cutting Length	100mm 3.93"	● 5000K	850lm/m	259lm/ft	F
Length/Reel	40m 131.23ft	● 6500K	850lm/m	259lm/ft	F
IP Grade	IP20				

IP65/8W

Product NO. FFH08W-P5-G2 28LZ9X 48VT120S12 W08L40

Power	8W/M 2.43W/ft	Lumens			ErP Class
Voltage	DC48V	● 2700K	700lm/m	213lm/ft	G
CRI	90	● 3000K	735lm/m	224lm/ft	F
Led Qty	120LEDs/M 36LEDs/ft	● 4000K	825lm/m	252lm/ft	F
Cutting Length	100mm 3.93"	● 5000K	825lm/m	252lm/ft	F
Length/Reel	40m 131.23ft	● 6500K	825lm/m	252lm/ft	F
IP Grade	IP65				

50M / 120LEDs / PCB 10MM

IP20/8W

Product NO. FH08W-P0-G1 28LZ9X 48VT120S12 W10L50

Power	8W/M 2.43W/ft	Lumens			ErP Class
Voltage	DC48V	● 2700K	720lm/m	220lm/ft	G
CRI	90	● 3000K	770lm/m	235lm/ft	F
Led Qty	120LEDs/M 36LEDs/ft	● 4000K	850lm/m	259lm/ft	F
Cutting Length	100mm 3.93"	● 5000K	850lm/m	259lm/ft	F
Length/Reel	50m 164.04ft	● 6500K	850lm/m	259lm/ft	F
IP Grade	IP20				

IP65/8W

Product NO. FH08W-P5-G2 28LZ9X 48VT120S12 W10L50

Power	8W/M 2.43W/ft	Lumens			ErP Class
Voltage	DC48V	● 2700K	705lm/m	215lm/ft	G
CRI	90	● 3000K	765lm/m	233lm/ft	F
Led Qty	120LEDs/M 36LEDs/ft	● 4000K	840lm/m	256lm/ft	F
Cutting Length	100mm 3.93"	● 5000K	840lm/m	256lm/ft	F
Length/Reel	50m 164.04ft	● 6500K	840lm/m	256lm/ft	F
IP Grade	IP65				

Note: 'x' (CCT) = "27"(2700K) / "30"(3000K) / "40"(4000K) / "50"(5000K) / "60"(6000K), Please contact us for more information.

* Please contact our sales for the latest details and certifications

48V Ultra-Long Series Mini Cut

Single end power carries 50M.
Uniform brightness from end to end.
Up to 106LM/W.
Easy to install & save time.



Dimension



Connectors List

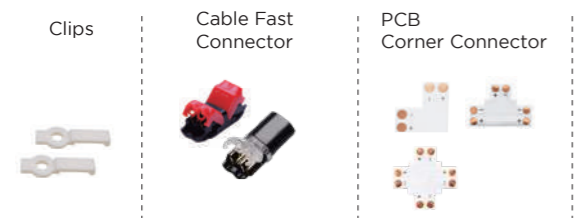

* Please Go to page 248 for Accessory and Connector Usage Guidelines.

40M / 64LEDs / PCB 10MM

IP20 / 4.8W

Product NO.
FH05W-PO-G1 28BL9X 48VT64S4 W10L40

Technical Details		Lumens		ErP Class
Power	4.8W/M 1.46W/ft	2700K	455lm/m 139lm/ft	F
Voltage	DC48V	3000K	470lm/m 143lm/ft	F
CRI	90	4000K	485lm/m 148lm/ft	F
Led Qty	64LEDs/M 19LEDs/ft	5000K	485lm/m 148lm/ft	F
Cutting Length	62.5mm 2.46"	6000K	485lm/m 148lm/ft	F
Length/Reel	40m 131.23ft			
IP Grade	IP20			

20M / 64LEDs / PCB 10MM

IP65 / 4.8W

Product NO.
FH05W-P5-G2 28BL9X 48VT64S4 W10L20

Technical Details		Lumens		ErP Class
Power	4.8W/M 1.46W/ft	2700K	435lm/m 133lm/ft	G
Voltage	DC48V	3000K	445lm/m 136lm/ft	F
CRI	90	4000K	455lm/m 139lm/ft	F
Led Qty	64LEDs/M 19LEDs/ft	5000K	455lm/m 139lm/ft	F
Cutting Length	62.5mm 2.46"	6000K	455lm/m 139lm/ft	F
Length/Reel	20m 65.61ft			
IP Grade	IP65			



48V Ultra-Long Series

High Efficiency

Single end power carries 50M.
Uniform brightness from end to end.
Up to 106LM/W.
Easy to install & save time.



Dimension

IP20

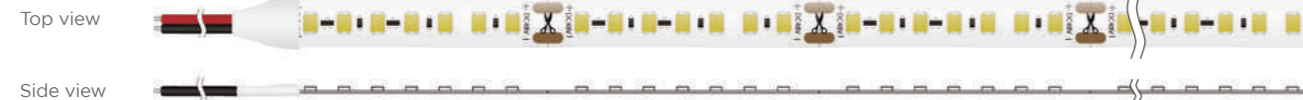

IP65



Connectors List

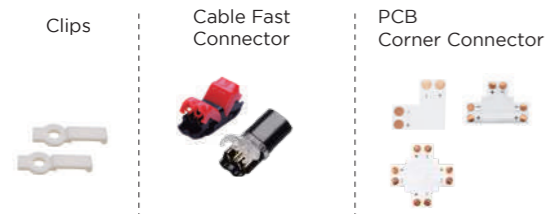

* Please Go to page 248 for Accessory and Connector Usage Guidelines.

20M / 140LEDs / PCB 10MM

IP20/14.4W

Product NO. FH14W-P0-G1 28BL9X 48VT140S7 W10L20

Power	14.4W/M 4.39W/ft	Lumens			ErP Class
Voltage	DC48V	● 2700K	1730lm/m	527lm/ft	E
CRI	90	● 3000K	1870lm/m	570lm/ft	E
Led Qty	140LEDs/M 42LEDs/ft	● 4000K	1885lm/m	575lm/ft	E
Cutting Length	50mm 1.97"	● 5000K	1885lm/m	575lm/ft	E
Length/Reel	20m 65.61ft	● 6500K	1885lm/m	575lm/ft	E
IP Grade	IP20				

IP65/14.4W

Product NO. FH14W-P5-G2 28BL9X 48VT140S7 W10L20

Power	14.4W/M 4.39W/ft	Lumens			ErP Class
Voltage	DC48V	● 2700K	1670lm/m	509lm/ft	F
CRI	90	● 3000K	1800lm/m	549lm/ft	E
Led Qty	140LEDs/M 42LEDs/ft	● 4000K	1825lm/m	556lm/ft	E
Cutting Length	50mm 1.97"	● 5000K	1825lm/m	556lm/ft	E
Length/Reel	20m 65.61ft	● 6500K	1825lm/m	556lm/ft	E
IP Grade	IP65				

10M / 140LEDs / PCB 10MM

IP20/19.2W

Product NO. FH19W-P0-G1 28BL9X 48VT140S7 W10L10

Power	19.2W/M 5.94W/ft	Lumens			ErP Class
Voltage	DC48V	● 2700K	2340lm/m	713lm/ft	E
CRI	90	● 3000K	2515lm/m	767lm/ft	E
Led Qty	140LEDs/M 42LEDs/ft	● 4000K	2550lm/m	777lm/ft	E
Cutting Length	50mm 1.97"	● 5000K	2550lm/m	777lm/ft	E
Length/Reel	10m 32.8ft	● 6500K	2550lm/m	777lm/ft	E
IP Grade	IP20				

IP65/19.2W

Product NO. FH19W-P5-G2 28BL9X 48VT140S7 W10L10

Power	19.2W/M 5.94W/ft	Lumens			ErP Class
Voltage	DC48V	● 2700K	2225lm/m	678lm/ft	F
CRI	90	● 3000K	2400lm/m	732lm/ft	E
Led Qty	140LEDs/M 42LEDs/ft	● 4000K	2420lm/m	738lm/ft	E
Cutting Length	50mm 1.97"	● 5000K	2420lm/m	738lm/ft	E
Length/Reel	10m 32.8ft	● 6500K	2420lm/m	738lm/ft	E
IP Grade	IP65				

Note: 'x' (CCT) = "27"(2700K) / "30"(3000K) / "40"(4000K) / "50"(5000K) / "60"(6000K), Please contact us for more information.

* Please contact our sales for the latest details and certifications

48V Ultra-Long Series Mini Size

Single end power carries 10M.
Uniform brightness from end to end.
Up to 100LM/W.
Easy to install & save time.



10M / 208LEDs / PCB4MM

IP20 / 8W

Product NO.

FH08W-PO-G1 22LZ9X 48V208S13 W04L10

Technical Details

Power	8W/M 2.43W/ft
Voltage	DC48V
CRI	90
Led Qty	208LEDs/M 63LEDs/ft
Cutting Length	62.5mm 2.46"
Length/Reel	10m 32.8ft
IP Grade	IP20

Lumens

Color	lm/m	lm/ft	ErP Class
2700K	720lm/m	220lm/ft	G
3000K	816lm/m	249lm/ft	F
4000K	880lm/m	268lm/ft	F
5000K	880lm/m	268lm/ft	F
6000K	880lm/m	268lm/ft	F

ErP Class

Dimension

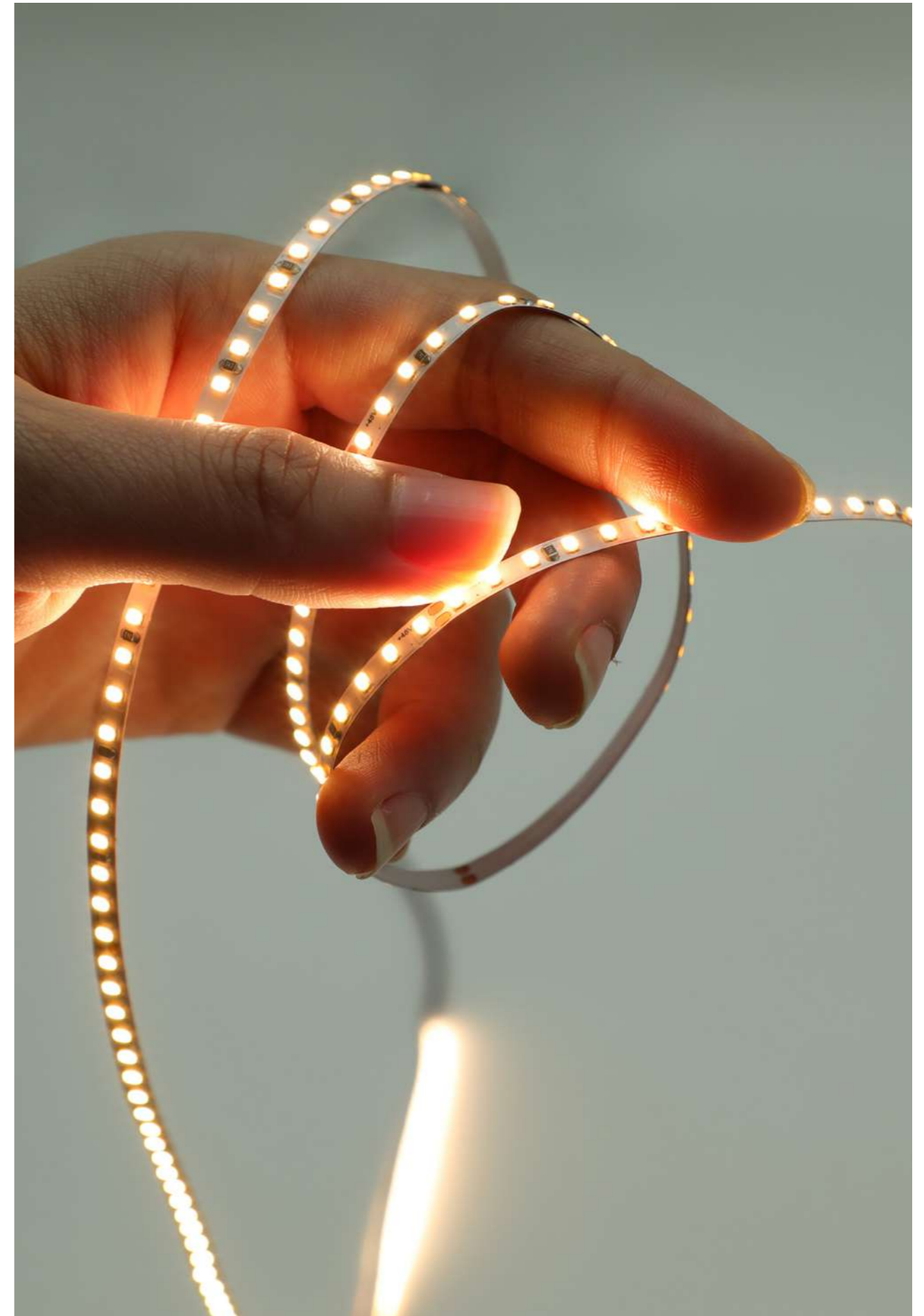

48V Ultra-Long Series Tunable CCT

Single end power carries 20M.
Uniform brightness from end to end.
Easy to install & save time.



20M / 140LEDs / PCB10MM

IP20 / 14W

Product NO.

FH14C-PO-G1 28BL92728BL960 48VC140S14 W10L20

Technical Details

Power	14W/M 4.26W/ft
Voltage	DC48V
CRI	90
Led Qty	140LEDs/M 42LEDs/ft
Cutting Length	100mm 1.97"
Length/Reel	20m 65.61ft
IP Grade	IP20 / IP65

Lumens

● 2700K	860lm/m	262lm/ft
● 6000K	960lm/m	293lm/ft

Dimension



48V Ultra-Long Series RGB

Single end power carries 20M.
Uniform brightness from end to end.
Easy to install & save time.



20M / 66LEDs / PCB10MM

IP20 / 13W

Product NO.

FH13C-PO-G1 50ZRGB 48VC66S11 W10L20

Technical Details

Power	13W/M 3.96W/ft
Voltage	DC48V
CRI	- (5050)
Led Qty	66LEDs/M 20LEDs/ft
Cutting Length	166.67mm 6.56"
Length/Reel	20m 65.61ft
IP Grade	IP20 / IP65



Lumens

● R	150lm/m	46lm/ft
● G	380lm/m	116lm/ft
● B	75lm/m	23lm/ft

Dimension



48V Ultra-Long Series RGBW

Single end power carries 20M.
Uniform brightness from end to end.
Easy to install & save time.



20M / 88LEDs / PCB12MM

IP20 / 15W

Product NO.

FH15C-P0-G1 50ZRGB930 48VC88S11 W12L20

Technical Details

Power	15W/M 4.57W/ft
Voltage	DC48V
CRI	90 (5050)
Led Qty	88LEDs/M 26LEDs/ft
Cutting Length	125mm 4.92"
Length/Reel	20m 65.61ft
IP Grade	IP20 / IP65



Lumens

● R	150lm/m	46lm/ft
● G	380lm/m	116lm/ft
● B	75lm/m	23lm/ft
● 3000K	305lm/m	93lm/ft

Dimension

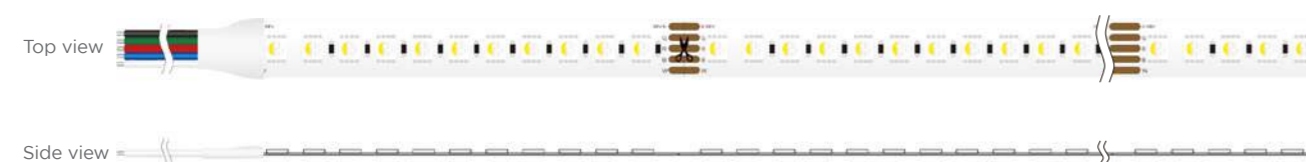

110-220V High Voltage Ultra-Long Series

Perfect color control.
3M tape, Cuttable, large bending degree,
easy installation.
Ultra-long, up to 50 meters one end feed.



110V High Voltage Strips

Ultra-long, up to 50 meters one end feed.

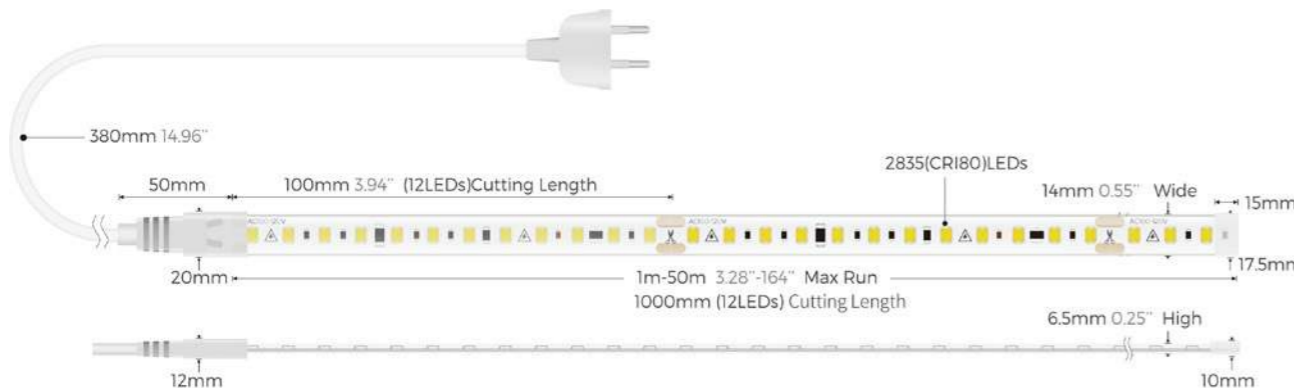

Technical Details White 12W

Product NO.	FE12W-P5-G2 28BL8x 220V120S12 1465L50	● 2700K	1380lm/m	421lm/ft
Voltage	DC110V	● 3000K	1440lm/m	439lm/ft
Power	12W/M 3.66W/ft	● 4000K	1500lm/m	457lm/ft
CRI	80	○ 6000K	1500lm/m	457lm/ft
Led Qty	120LEDs/M 36LEDs/ft			
Cutting Length	100mm 3.93"			
IP Grade	IP65			
Length/Reel	50m 164.04ft			

Accessories



220V High Voltage Strips

Ultra-long, up to 50 meters one end feed.



Ordinary solution

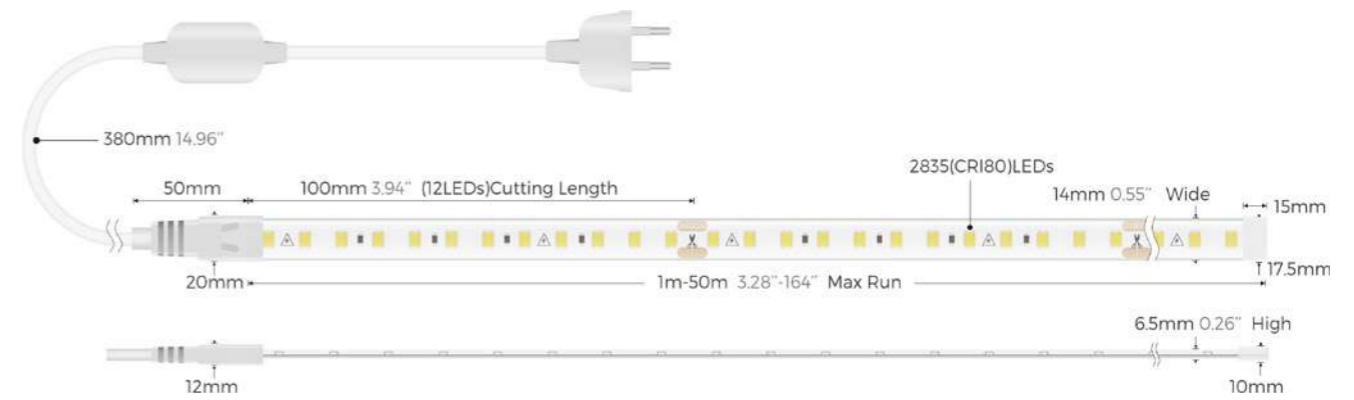

Technical Details White 12W

Product NO.	FE12W-P5-G2 28BL8x 220V120S12 1465L50	● 2700K	1380lm/m	421lm/ft
Voltage	DC220V	● 3000K	1440lm/m	439lm/ft
Power	12W/M 3.66W/ft	● 4000K	1500lm/m	457lm/ft
CRI	80	○ 6000K	1500lm/m	457lm/ft
Led Qty	120LEDs/M 36LEDs/ft			
Cutting Length	100mm 3.93"			
IP Grade	IP65			
Length/Reel	50m 164.04ft			

Accessories



220V High Voltage Strips

Ultra-long, up to 50 meters one end feed.

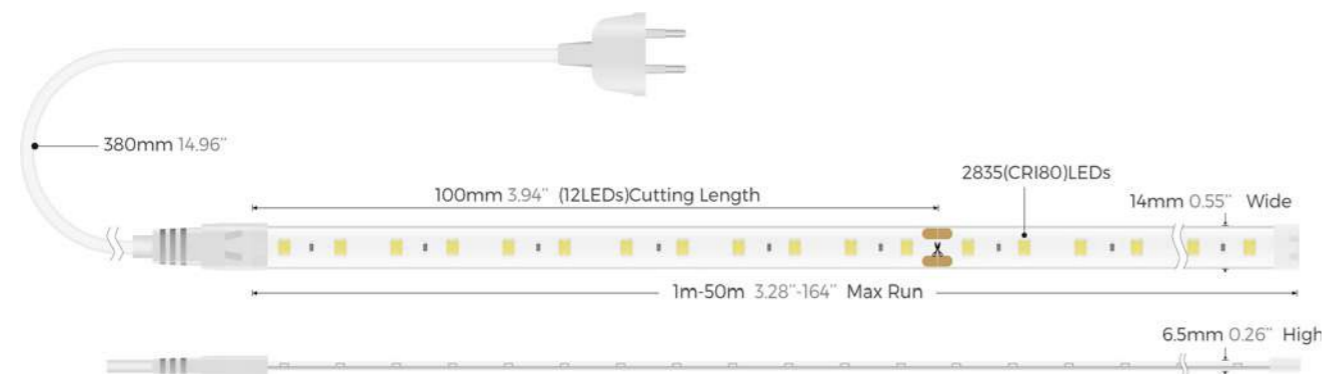

Technical Details **White 12W**

Product NO.	FE12W-P5-G2 28BL8x 220VC120S12 1465L50	● 2700K	1380lm/m	421lm/ft
Voltage	DC220V	● 3000K	1440lm/m	439lm/ft
Power	12W/M 3.66W/ft	● 4000K	1500lm/m	457lm/ft
CRI	80	○ 6000K	1500lm/m	457lm/ft
Led Qty	120LEDs/M 36LEDs/ft			
Cutting Length	100mm 3.93"			
IP Grade	IP65			
Length/Reel	50m 164.04ft			

Accessories



220V High Voltage Strips

Ultra-long, up to 50 meters one end feed.

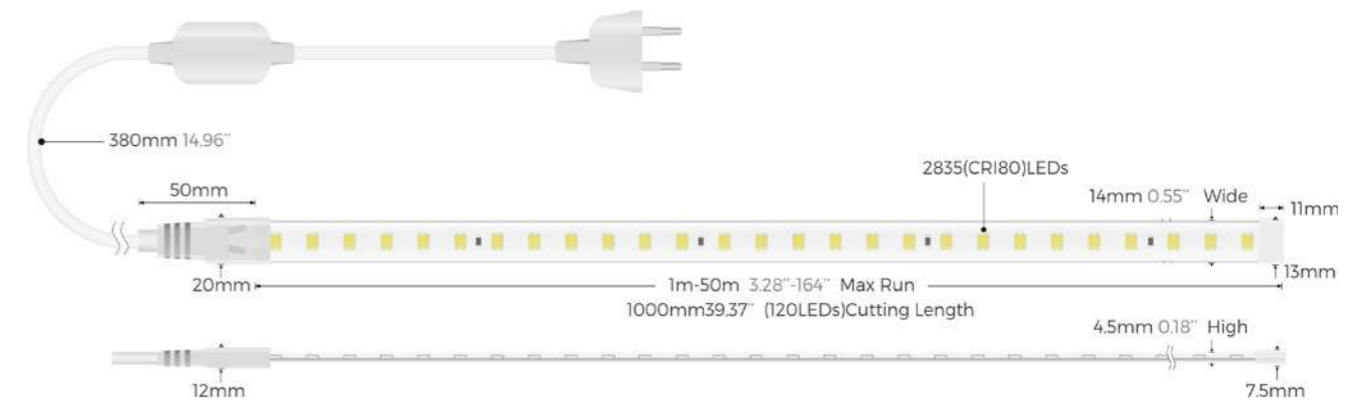

Technical Details **White 9W**

Product NO.	FE09W-P5-G2 28AK8x 220V120S120 1045RL50	● 2700K	790lm/m	240lm/ft
Voltage	DC220V	● 3000K	810lm/m	250lm/ft
Power	9W/M 2.74W/ft	● 4000K	825lm/m	251lm/ft
CRI	80	○ 6000K	825lm/m	251lm/ft
Led Qty	120LEDs/M 36LEDs/ft			
Cutting Length	100mm 3.93"			
IP Grade	IP65			
Length/Reel	50m 164.04ft			

Accessories



Mini LED

2216 Plus Series
2110 Series

2216 Plus Series

Reinforced Bracket, better bending resistance.
Smaller led, more space for marvelous design.
Matched with various aluminum profiles and optical covers,
no dots, to meet different lighting design requirements.

Mini PCB 3mm 6LEDs/Group

Mini PCB 3mm, Ultra-high density LEDs, reinforced bracket, ultra-flexible material, bigger bending radian.



	120LEDs/M PCB3mm	240LEDs/M PCB3MM
Product NO.	FE05W-PO-G1 22X9x 24V120S W03L05	FE10W-PO-G1 22X9x 24V240S W03L05
Power	4.8W/M 1.46W/ft	9.6W/M 2.93W/ft
Voltage	DC24V	DC24V
CRI	90	90
Led Qty	120LEDs/M 36LEDs/ft	240LEDs/M 73LEDs/ft
Length/Reel	5M 16.41ft	5M 16.41ft
Cutting Length	50mm 1.97"	25mm 0.98"
IP Grade	IP20	IP20
2700K	455lm/m 139lm/ft	890lm/m 271lm/ft
3000K	465lm/m 142lm/ft	930lm/m 284lm/ft
4000K	480lm/m 146lm/ft	960lm/m 293lm/ft
5000K	480lm/m 146lm/ft	960lm/m 293lm/ft
6000K	480lm/m 146lm/ft	960lm/m 293lm/ft

Note:'x' (CCT) = "27"(2700K) / "30"(3000K) / "40"(4000K) / "50"(5000K) / "60"(6000K), Please contact us for more information.
* Please contact our sales for the latest details and certifications

Mini PCB 4 / 6mm

7LEDs/Group



4/6mm PCB width, applied for ultra-narrow gap profiles and grooves to reach slimmer lighting performance.

	168LEDs/M PCB4mm	196LEDs/M PCB6MM
Product NO.	FE05W-PO-G1 22X9x 24V168S7 W04L05	FE10W-PO-G1 22X9x 24V196S7 W06L05
Power	4.8W/M 1.46W/ft	9.6W/M 2.93W/ft
Voltage	DC24V	DC24V
CRI	90	90
Led Qty	168LEDs/M 51LEDs/ft	196LEDs/M 60LEDs/ft
Length/Reel	5M 16.41ft	5M 16.41ft
Cutting Length	41.67mm 1.64"	35.7mm 1.41"
IP Grade	IP20	IP20
2700K	510lm/m 155lm/ft	985lm/m 300lm/ft
3000K	525lm/m 160lm/ft	1005lm/m 306lm/ft
4000K	545lm/m 166lm/ft	1055lm/m 322lm/ft
5000K	545lm/m 166lm/ft	1055lm/m 322lm/ft
6000K	545lm/m 166lm/ft	1055lm/m 322lm/ft

Note:'x' (CCT) = "27"(2700K) / "30"(3000K) / "40"(4000K) / "50"(5000K) / "60"(6000K), Please contact us for more information.
* Please contact our sales for the latest details and certifications

Dimension



	L1	L2	L3	W4
FE05W-PO-G1 22X9x 24V120S W03L05	5m 16.41ft	50mm 1.97"	8.33mm 0.33"	3mm 0.12"
FE10W-PO-G1 22X9x 24V240S W03L05	5m 16.41ft	25mm 0.98"	4.2mm 0.16"	3mm 0.12"
FE05W-PO-G1 22X9x 24V168S7 W04L05	5m 16.41ft	41.67mm 1.64"	5.95mm 0.23"	4mm 0.16"
FE10W-PO-G1 22X9x 24V196S7 W06L05	5m 16.41ft	35.7mm 1.41"	5.1mm 0.2"	6mm 0.24"

2216 Plus Series Free cut

LED STRIP SERIES · 2216 PLUS SERIES



Free cut, Ultra-high density LEDs, reinforced bracket, ultra-flexible material, bigger bending radian.
High density with homogeneous light.
High RA90 is available, which conform to the requirement of supplementary light.

Free cut



	300LEDs/M PCB8mm	300LEDs/M PCB10MM
Product NO.	FE12W-PO-G1 22X9x 24V300S1 W8L05	FE12W-PO-G1 22X9x 24V300S1 W10L05
Power	12W/M 3.66W/ft	12W/M 3.66W/ft
Voltage	DC24V	DC24V
CRI	90	90
Led Qty	300LEDs/M 92LEDs/ft	300LEDs/M 92LEDs/ft
Length/Reel	5M 16.41ft	5M 16.41ft
Soldering Pad Distance	20mm 0.79"	20mm 0.79"
IP Grade	IP20	IP20
2700K	960lm/m 293lm/ft	960lm/m 293lm/ft
3000K	1020lm/m 311lm/ft	1020lm/m 311lm/ft
4000K	1080lm/m 329lm/ft	1080lm/m 329lm/ft
5000K	1140lm/m 348lm/ft	1140lm/m 348lm/ft
6000K	1140lm/m 348lm/ft	1140lm/m 348lm/ft

Note: 'x' (CCT) = "27"(2700K) / "30"(3000K) / "40"(4000K) / "50"(5000K) / "60"(6000K), Please contact us for more information.
* Please contact our sales for the latest details and certifications

LED STRIP SERIES · 2216 PLUS SERIES

Dimension

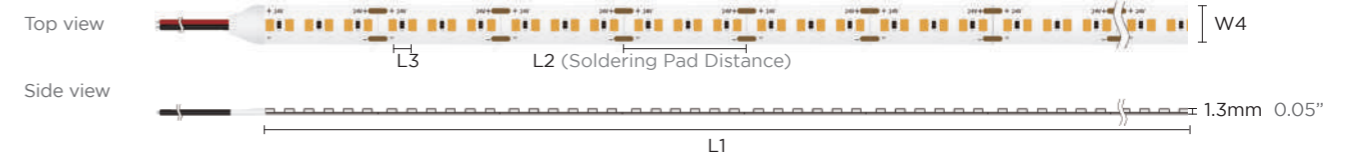

	L1	L2	L3	W4
FE12W-PO-G1 22X9x 24V300S1 W08L05	5m 16.41ft	20mm 0.79"	3.33mm 0.13"	8mm 0.32"
FE12W-PO-G1 22X9x 24V300S1 W10L05	5m 16.41ft	20mm 0.79"	3.33mm 0.13"	10mm 0.39"

420LEDs/m 12W

7LEDs/Group



Product NO.	FE12W-PO-G1 22X9x 24V420S7 W08L05	Lumens		
Power	12W/M 3.66W/ft	● 2700K	1295lm/m	395lm/ft
Voltage	DC24V	● 3000K	1320lm/m	402lm/ft
CRI	90	● 4000K	1355lm/m	413lm/ft
Led Qty	420LEDs/M 128LEDs/ft	● 5000K	1355lm/m	413lm/ft
Length/Reel	5M 16.41ft	● 6000K	1355lm/m	413lm/ft
Cutting Length	16.67mm 0.66"			
IP Grade	IP20			

Note: 'x' (CCT) = "27"(2700K) / "30"(3000K) / "40"(4000K) / "50"(5000K) / "60"(6000K), Please contact us for more information.
 * Please contact our sales for the latest details and certifications

504LEDs/m 14W

7LEDs/Group / Tunable CCT



Product NO.	FE14C-PO-G1 22X92722X965 24V504D28 W10L05	Lumens		
Power	14W/M 4.27W/ft	● 2700K	745lm/m	227lm/ft
Voltage	DC24V	● 6500K	780lm/m	238lm/ft
CRI	90			
Led Qty	504LEDs/M 154LEDs/ft			
Length/Reel	5M 16.41ft			
Cutting Length	55.56mm 2.19"			
IP Grade	IP20			

Note: 'x' (CCT) = "27"(2700K) / "30"(3000K) / "40"(4000K) / "50"(5000K) / "60"(6000K), Please contact us for more information.
 * Please contact our sales for the latest details and certifications

LED STRIP SERIES · 2216 PLUS SERIES

LED STRIP SERIES · 2216 PLUS SERIES

Dimension

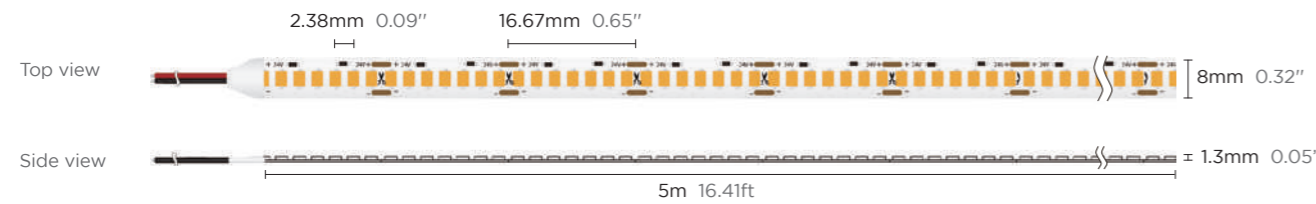

Dimension

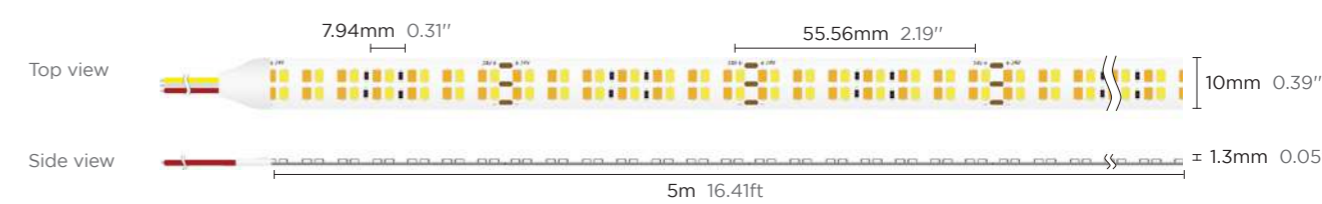

Connectors List



* Please Go to page 248 for Accessory and Connector Usage Guidelines.

Connectors List

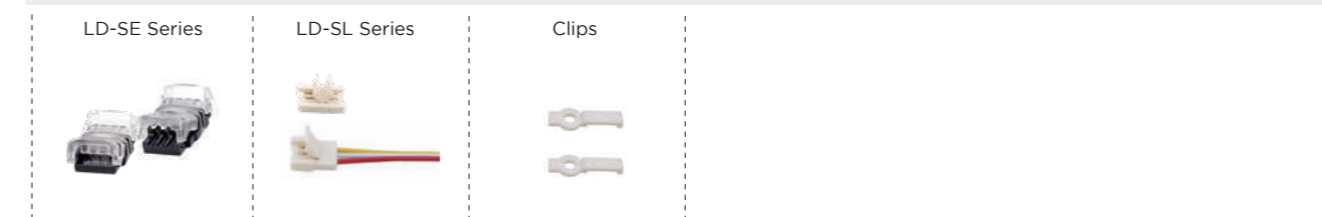

* Please Go to page 248 for Accessory and Connector Usage Guidelines.



420LEDs/m 12W IP65

7LEDs/Group



Product NO.	FE12W-P5-G1 22X9x 24V420S7 W08L05	Lumens		
Power	12W/M 3.66W/ft	● 2700K	1235lm/m	377lm/ft
Voltage	DC24V	● 3000K	1245lm/m	380lm/ft
CRI	90	● 4000K	1260lm/m	384lm/ft
Led Qty	420LEDs/M 128LEDs/ft	● 5000K	1260lm/m	384lm/ft
Length/Reel	5M 16.41ft	● 6000K	1260lm/m	384lm/ft
Cutting Length	16.67mm 0.66"			
IP Grade	IP65			

Note: 'x' (CCT) = "27"(2700K) / "30"(3000K) / "40"(4000K) / "50"(5000K) / "60"(6000K), Please contact us for more information.
 * Please contact our sales for the latest details and certifications

Dimension

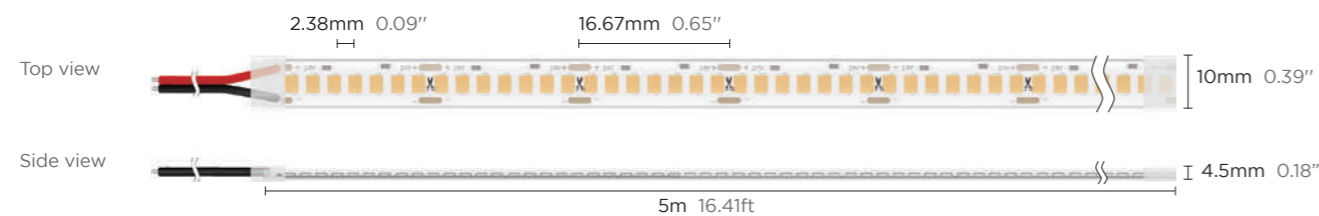

420LEDs/m 12W IP67

7LEDs/Group



Product NO.	FE12W-P7-G1 22X9x 24V420S7 W08L05	Lumens		
Power	12W/M 3.66W/ft	● 2700K	1140lm/m	348lm/ft
Voltage	DC24V	● 3000K	1165lm/m	355lm/ft
CRI	90	● 4000K	1185lm/m	361lm/ft
Led Qty	420LEDs/M 128LEDs/ft	● 5000K	1185lm/m	361lm/ft
Length/Reel	5M 16.41ft	● 6000K	1185lm/m	361lm/ft
Cutting Length	16.67mm 0.66"			
IP Grade	IP67			

Note: 'x' (CCT) = "27"(2700K) / "30"(3000K) / "40"(4000K) / "50"(5000K) / "60"(6000K), Please contact us for more information.
 * Please contact our sales for the latest details and certifications

Dimension

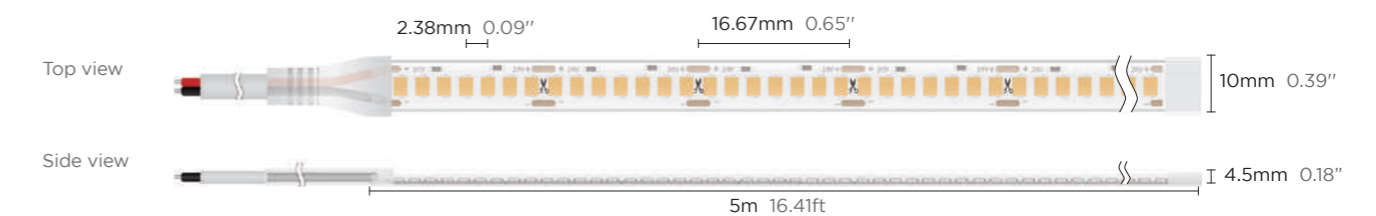

2110 Series

Reinforced Bracket, better bending resistance.
Smaller led, more space for marvelous design.
Matched with various aluminum profiles and optical covers,
no dots, to meet different lighting design requirements.



120LEDs/M 7.2W 6LEDs/Group

Product NO. FE07W-PO-G1 21X9x 24V120S W04L05



4mm PCB width, applied for ultra-narrow gap profiles and grooves to reach slimmer lighting performance.



Mini PCB 4mm

Technical Details

Technical Details		Lumens	
Power	7.2W/M 2.20W/ft	● 2200K	500lm/m 152lm/ft
Voltage	DC24V	● 2500K	520lm/m 159lm/ft
CRI	90	● 2700K	530lm/m 162lm/ft
Led Qty	120LEDs/M 36LEDs/ft	● 3000K	580lm/m 177lm/ft
Length/Reel	5M 16.41ft	● 4000K	620lm/m 189lm/ft
Cutting Length	50mm 1.97"	● 5000K	610lm/m 186lm/ft
IP Grade	IP20	● 6000K	600lm/m 183lm/ft

Note: 'x' (CCT) = 27°(2700K) / 30°(3000K) / 40°(4000K) / 50°(5000K) / 60°(6000K). Please contact us for more information.
* Please contact our sales for the latest details and certifications

Dimension

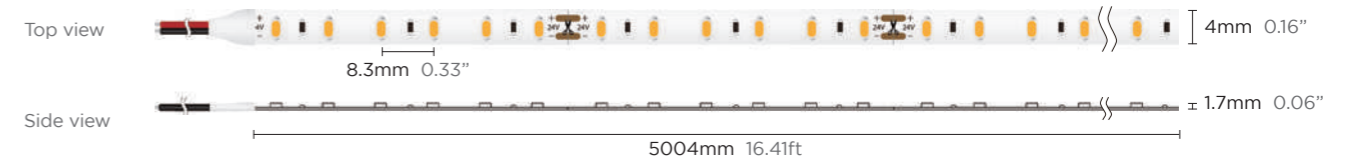

180LEDs/M 12W

6LEDs/Group

Product NO. FE12W-PO-G1 21X9x 24V180S W10L05



Small size 2110, strong bracket, bending resistant.
High Density, combines AL profile and PC cover to create dot-free light.



IP Grade



Technical Details

Technical Details		Lumens	
Power	12W/M 3.66W/ft	● 2200K	800lm/m 244lm/ft
Voltage	DC24V	● 2500K	850lm/m 259lm/ft
CRI	90	● 2700K	870lm/m 265lm/ft
Led Qty	180LEDs/M 54LEDs/ft	● 3000K	960lm/m 293lm/ft
Length/Reel	5M 16.41ft	● 4000K	1030lm/m 314lm/ft
Cutting Length	33.3mm 1.31"	● 5000K	1010lm/m 38lm/ft
IP Grade	IP20/IP62/IP65/IP67/IP68	● 6000K	1000lm/m 305lm/ft

Note: 'x' (CCT) = "27"(2700K) / "30"(3000K) / "40"(4000K) / "50"(5000K) / "60"(6000K), Please contact us for more information.
* Please contact our sales for the latest details and certifications

Dimension

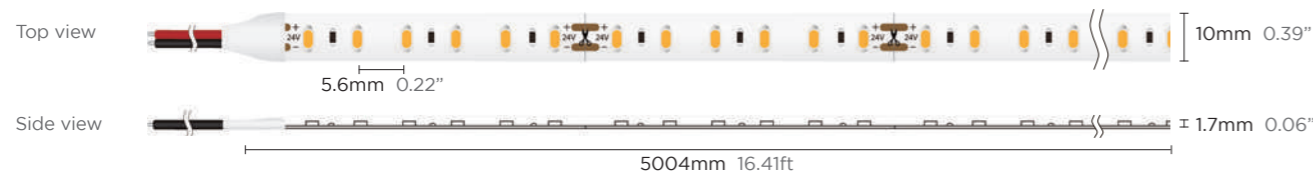

Connectors List



* Please Go to page 248 for Accessory and Connector Usage Guidelines.

240LEDs/M 15W

6LEDs/Group

Product NO. FE15W-PO-G1 21X9x 24V240S W10L05



Small size 2110, strong bracket, bending resistant.
High Density, combines AL profile and PC cover to create dot-free light.



IP Grade

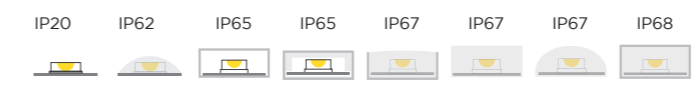

Technical Details

Technical Details		Lumens	
Power	15W/M 4.6W/ft	● 2200K	980lm/m 299lm/ft
Voltage	DC24V	● 2500K	1050lm/m 320lm/ft
CRI	90	● 2700K	1070lm/m 326lm/ft
Led Qty	240LEDs/M 73LEDs/ft	● 3000K	1170lm/m 357lm/ft
Length/Reel	5M 16.41ft	● 4000K	1260lm/m 384lm/ft
Cutting Length	25mm 0.98"	● 5000K	1240lm/m 378lm/ft
IP Grade	IP20/IP62/IP65/IP67/IP68	● 6000K	1200lm/m 366lm/ft

Note: 'x' (CCT) = "27"(2700K) / "30"(3000K) / "40"(4000K) / "50"(5000K) / "60"(6000K), Please contact us for more information.
* Please contact our sales for the latest details and certifications

Dimension

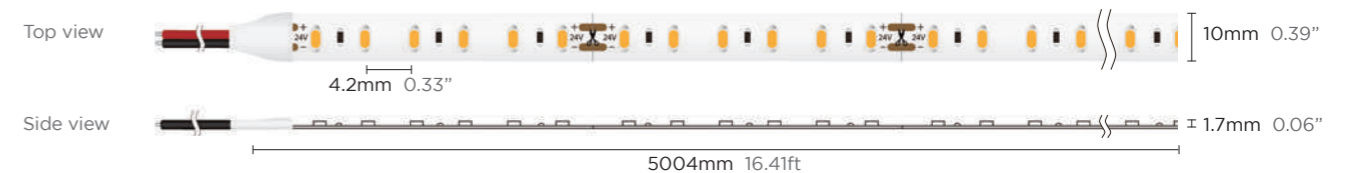

Connectors List



* Please Go to page 248 for Accessory and Connector Usage Guidelines.

300LEDs/M 18W

6LEDs/Group

Product NO. FE18W-PO-G1 21X9x 24V300S W10L05



Small size 2110, strong bracket, bending resistant.
High Density, combines AL profile and PC cover to create dot-free light.



IP Grade



Technical Details

Technical Details		Lumens		
Power	18W/M 5.49W/ft	● 2200K	1170lm/m	357lm/ft
Voltage	DC24V	● 2500K	1270lm/m	387lm/ft
CRI	90	● 2700K	1340lm/m	409lm/ft
Led Qty	300LEDs/M 91LEDs/ft	● 3000K	1460lm/m	445lm/ft
Length/Reel	5M 16.41ft	● 4000K	1540lm/m	470lm/ft
Cutting Length	20mm 0.79"	● 5000K	1500lm/m	457lm/ft
IP Grade	IP20/IP62/IP65/IP67/IP68	● 6000K	1490lm/m	454lm/ft

Note: 'x' (CCT) = "27"(2700K) / "30"(3000K) / "40"(4000K) / "50"(5000K) / "60"(6000K), Please contact us for more information.
* Please contact our sales for the latest details and certifications

Dimension

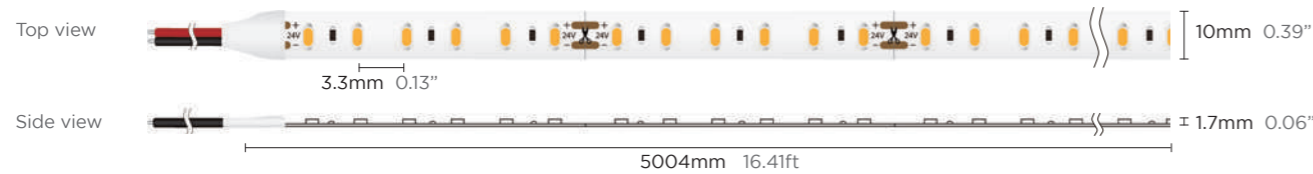

Connectors List



* Please Go to page 248 for Accessory and Connector Usage Guidelines.

280LEDs/M 18W

7LEDs/Group

Product NO. FE18W-PO-G1 21X9x 24V280S7 W10L05



Small size 2110, strong bracket, bending resistant.
High Density, combines AL profile and PC cover to create dot-free light.



IP Grade

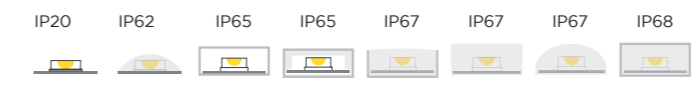

Technical Details

Technical Details		Lumens		
Power	18W/M 5.49W/ft	● 2200K	1390lm/m	424lm/ft
Voltage	DC24V	● 2500K	1435lm/m	438lm/ft
CRI	90	● 2700K	1555lm/m	474lm/ft
Led Qty	280LEDs/M 85LEDs/ft	● 3000K	1608lm/m	490lm/ft
Length/Reel	5M 16.41ft	● 4000K	1661lm/m	506lm/ft
Cutting Length	25mm 0.98"	● 5000K	1635lm/m	498lm/ft
IP Grade	IP20/IP62/IP65/IP67/IP68	● 6000K	1635lm/m	498lm/ft

Note: 'x' (CCT) = "27"(2700K) / "30"(3000K) / "40"(4000K) / "50"(5000K) / "60"(6000K), Please contact us for more information.
* Please contact our sales for the latest details and certifications

Dimension

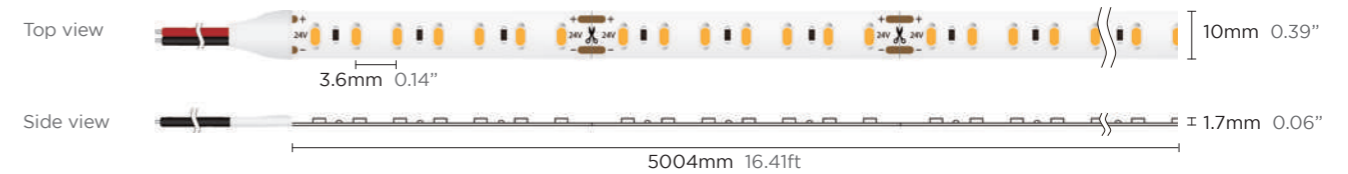

Connectors List



* Please Go to page 248 for Accessory and Connector Usage Guidelines.

700LEDs/M 18W

7LEDs/Group

Product NO. FE18W-PO-G1 21X9x 24V700S W10L05



Small size 2110, strong bracket, bending resistant.
High Density, combines AL profile and PC cover to create dot-free light.



IP Grade

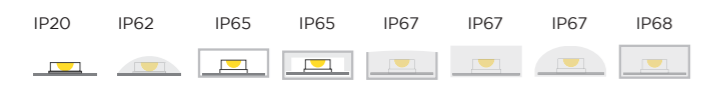

Technical Details

Power	18W/M 5.49W/ft	Lumens		
		2200K	1619lm/m 494lm/ft	
Voltage	DC24V	2500K	1665lm/m 508lm/ft	
CRI	90	2700K	1804lm/m 550lm/ft	
Led Qty	700LEDs/M 213LEDs/ft	3000K	1865lm/m 569lm/ft	
Length/Reel	5M 16.41ft	4000K	1927lm/m 588lm/ft	
Cutting Length	10mm 0.39"	5000K	1896lm/m 578lm/ft	
IP Grade	IP20/IP62/IP65/IP67/IP68	6000K	1896lm/m 578lm/ft	

Note: 'x' (CCT) = "27"(2700K) / "30"(3000K) / "40"(4000K) / "50"(5000K) / "60"(6000K), Please contact us for more information.
* Please contact our sales for the latest details and certifications

Dimension

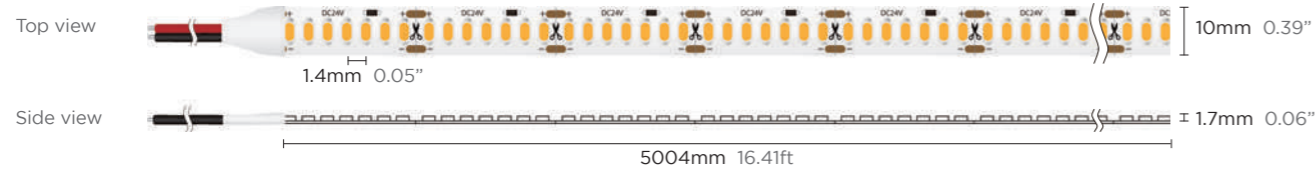

Connectors List



* Please Go to page 248 for Accessory and Connector Usage Guidelines.

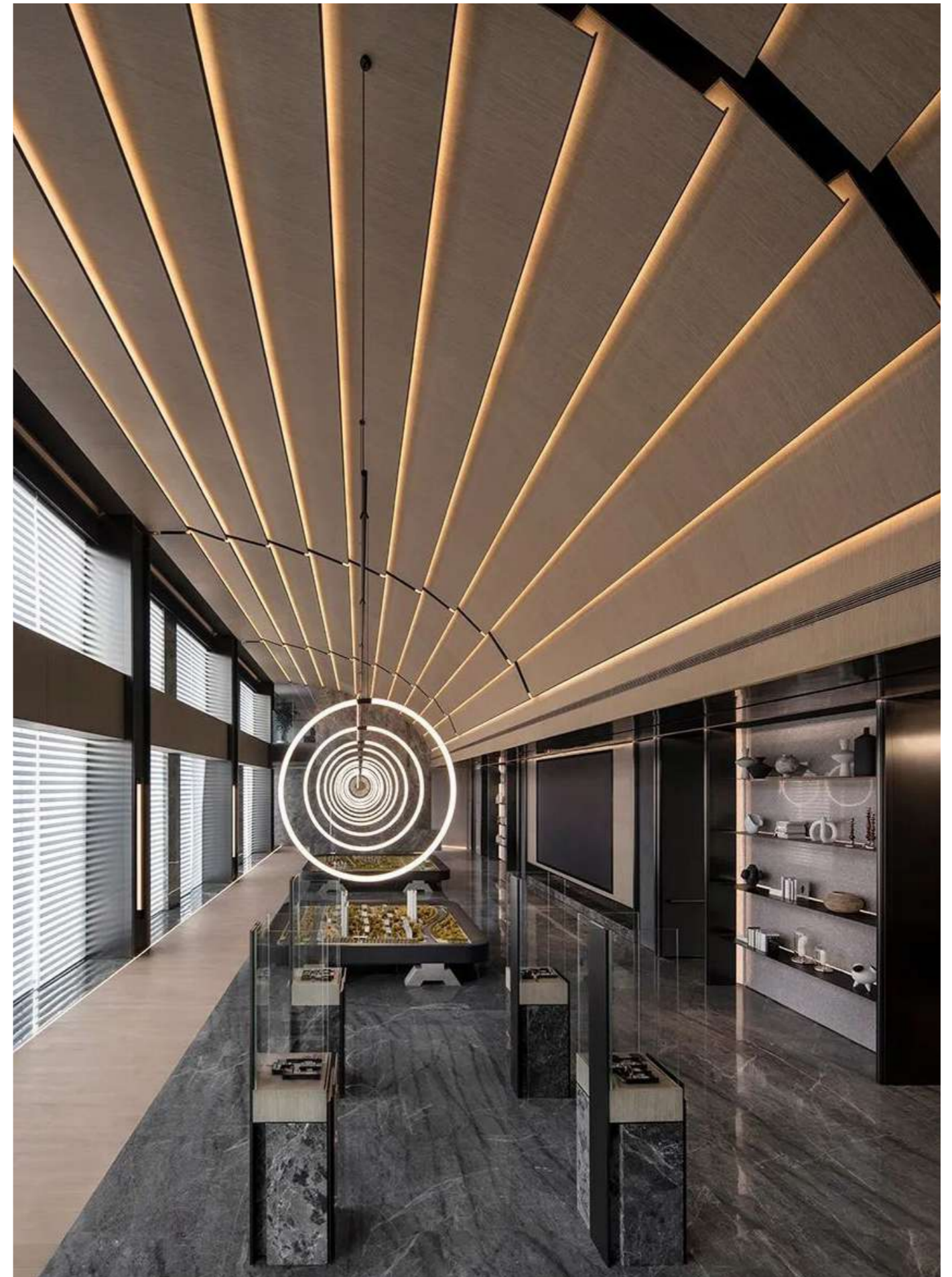

DTW-dim to warm Series



140LEDs/M 8W

Product NO. FH08C-PO-G1 28HZ91928HZ930 24V140S14 W10L05 D2W



IP Grade

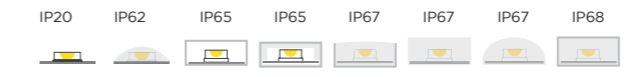

Technical Details

Power	8W/M 2.44W/ft
Voltage	DC24V
CRI	90
Led Qty	140LEDs/M 42LEDs/ft
Length/Reel	5M 16.41ft
Cutting Length	100mm 3.94"
IP Grade	IP20/IP62/IP65/IP67/IP68

Lumens

● 1900K	35lm/m	11lm/ft
● 3000K	730lm/m	222lm/ft

Note: 'x' (CCT) = *27*(2700K) / *30*(3000K) / *40*(4000K) / *50*(5000K) / *60*(6000K), Please contact us for more information.
* Please contact our sales for the latest details and certifications

Dimension

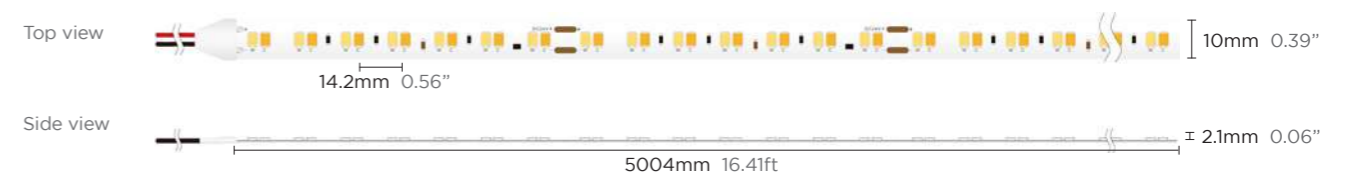

Connectors List

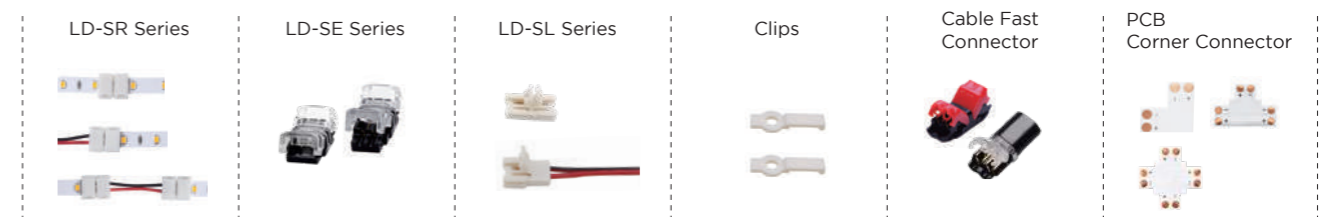

* Please Go to page 248 for Accessory and Connector Usage Guidelines.

Dim to Warm

Can meet different color temperature requirements. The matched control system can achieve uniform color temperature and brightness adjustment.

168LEDs/M 10W

Product NO. FH10C-P0-G2 28HX91928HX930 24VT168S14 W10L05 D2W



IP Grade



Technical Details

Power	10W/M 3.04W/ft
Voltage	DC24V
CRI	90
Led Qty	168LEDs/M 51LEDs/ft
Length/Reel	5M 16.41ft
Cutting Length	83.3mm 3.27"
IP Grade	IP20/IP62/IP65/IP67/IP68

Lumens

● 1900K	60lm/m	18lm/ft
● 3000K	1100lm/m	335lm/ft

Note: 'x' (CCT) = "27"(2700K) / "30"(3000K) / "40"(4000K) / "50"(5000K) / "60"(6000K), Please contact us for more information.

* Please contact our sales for the latest details and certifications

Dimension



Connectors List



* Please Go to page 248 for Accessory and Connector Usage Guidelines.

280LEDs/M 15W

Product NO. FP15C-P0-G1 22X92122X930 24VT280S W10L05 D2W



IP Grade

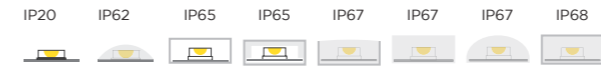

Technical Details

Power	15W/M 4.57W/ft
Voltage	DC24V
CRI	90
Led Qty	280LEDs/M 85LEDs/ft
Length/Reel	5M 16.41ft
Cutting Length	50mm 1.97"
IP Grade	IP20/IP62/IP65/IP67/IP68

Lumens

● 1900K	35lm/m	11lm/ft
● 3000K	1450lm/m	442lm/ft

Note: 'x' (CCT) = "27"(2700K) / "30"(3000K) / "40"(4000K) / "50"(5000K) / "60"(6000K), Please contact us for more information.

* Please contact our sales for the latest details and certifications

Dimension



Connectors List

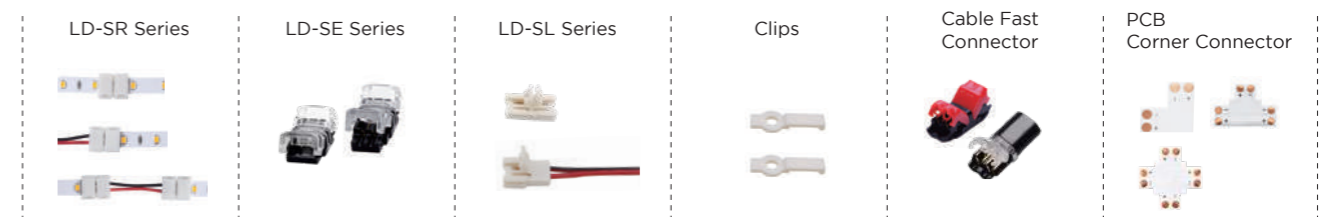

* Please Go to page 248 for Accessory and Connector Usage Guidelines.

168LEDs/M 15W

Product NO. FP15C-P0-G1 28LZ92028LZ930 24VT168S14 W10L05 D2W PWM



IP Grade



Technical Details

Power	15W/M 4.57W/ft
Voltage	DC24V
CRI	90
Led Qty	168LEDs/M 51LEDs/ft
Length/Reel	5M 16.41ft
Cutting Length	83.3mm 3.27"
IP Grade	IP20/IP62/IP65/IP67/IP68

Lumens

● 2700K	42lm/m	12lm/ft
● 3000K	1300lm/m	396lm/ft

Note: 'x' (CCT) = "27"(2700K) / "30"(3000K) / "40"(4000K) / "50"(5000K) / "60"(6000K), Please contact us for more information.

* Please contact our sales for the latest details and certifications

Dimension

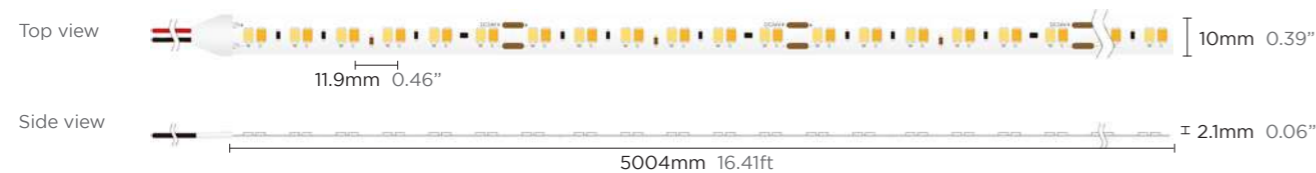

Connectors List



* Please Go to page 248 for Accessory and Connector Usage Guidelines.

240LEDs/M 16W

Product NO. FP16C-P0-G1 22X91822X930 24VT240S W10L05 D2W



IP Grade

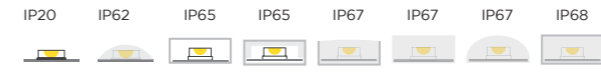

Technical Details

Power	16W/M 4.87W/ft
Voltage	DC24V
CRI	90
Led Qty	240LEDs/M 73LEDs/ft
Length/Reel	5M 16.41ft
Cutting Length	50mm 1.97"
IP Grade	IP20/IP62/IP65/IP67/IP68

Lumens

● 1800K	40lm/m	12lm/ft
● 3000K	1190lm/m	323lm/ft

Note: 'x' (CCT) = "27"(2700K) / "30"(3000K) / "40"(4000K) / "50"(5000K) / "60"(6000K), Please contact us for more information.

* Please contact our sales for the latest details and certifications

Dimension

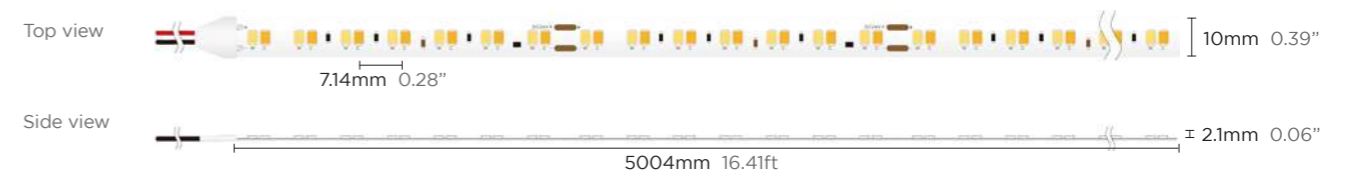

Connectors List



* Please Go to page 248 for Accessory and Connector Usage Guidelines.

Constant current Resistor-free LED strip

Up to 10m

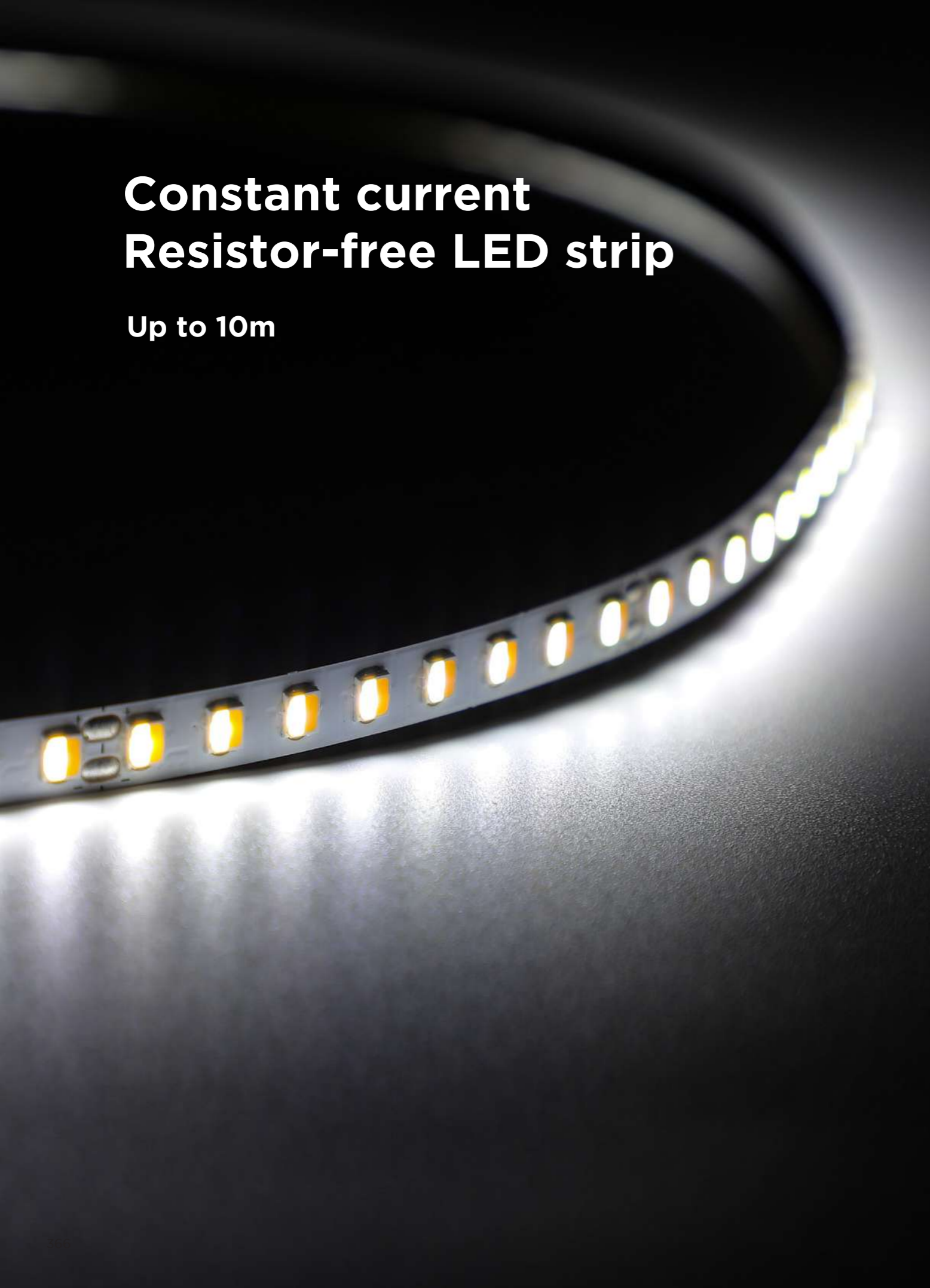

White 13W

Product NO.

FE13W-P0-G1 28LX8x 36CC240S12 W06L10

Power	8W/M 2.44W/ft
Voltage	DC32-36V
Constant current	0.4A/M
CRI	80
Led Qty	140LEDs/M 42LEDs/ft
Length/Reel	10M 32ft
Cutting Length	50mm 1.97"
IP Grade	IP20

Tunable CCT 18W

Product NO.

FE18C-P0-G1 28Z83057 24CC160S8 W06L10

Power	18W/M 5.49W/ft
Voltage	DC21-24V
Constant current	0.8A/M
CRI	80
Led Qty	160LEDs/M 48LEDs/ft
Length/Reel	10M 32ft
Cutting Length	50mm 1.97"
IP Grade	IP20

Lumens

● 2700K	2050lm/m	625lm/ft	● 3000K	2700lm/m	823lm/ft
● 3000K	2080lm/m	634lm/ft	● 5700K	2770lm/m	844lm/ft
● 4000K	2145lm/m	654lm/ft			
● 5000K	2145lm/m	654lm/ft			
● 6000K	2145lm/m	654lm/ft			

Note: 'x' (CCT) = "27"(2700K) / "30"(3000K) / "40"(4000K) / "50"(5000K) / "60"(6000K), Please contact us for more information.

Dimension

White



Tunable CCT



Sauna Room LED strip



Up to IP65



More stable

5 years warranty@Ta 85°C
 3 years warranty@Ta 100°C
 Apply to bathroom sauna.



High temperature and high storage condition,
 Ta:-30-100°C, apply to bathroom sauna

Product NO.

FH06W-P5-G1Y 30Z8x 24V80S4 W10L05



Technical Details

Power	6W/M 1.82W/ft	Lumens		
Voltage	DC24V	● 2700K	1010lm/m	307lm/ft
CRI	80	● 3000K	1050lm/m	320lm/ft
Led Qty	80LEDs/M 24LEDs/ft	● 4000K	1110lm/m	335lm/ft
Length/Reel	5004mm 16.41ft	● 5000K	1140lm/m	347lm/ft
Cutting Length	50mm 1.97"	● 6000K	1140lm/m	347lm/ft
IP Grade	IP65			

Note: 'x' (CCT) = "27"(2700K) / "30"(3000K) / "40"(4000K) / "50"(5000K) / "60"(6000K), Please contact us for more information.
 * Please contact our sales for the latest details and certifications

Dimension



Accessories



Swimming Pool LED Strip

Up to 10m

Safety.
Durable, Corrosion-resistant.
Easy to Install.

IP68

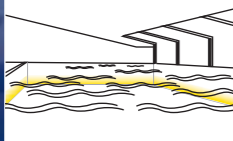

Product NO.
FE10W-P8-G1 28HX9x 24VT120S W10L10



Technical Details

Power	9.6W/M 2.93W/ft	Lumens		
Voltage	DC24V	● 2700K	770lm/m	235lm/ft
CRI	90	● 3000K	805lm/m	245lm/ft
Led Qty	120LEDs/M 36LEDs/ft	● 4000K	825lm/m	251lm/ft
Length/Reel	10m 32.8ft	● 5000K	825lm/m	251lm/ft
Cutting Length	50mm 1.97"	● 6000K	825lm/m	251lm/ft
IP Grade	IP68			

Note: 'x' (CCT) = "27"(2700K) / "30"(3000K) / "40"(4000K) / "50"(5000K) / "60"(6000K), Please contact us for more information.
* Please contact our sales for the latest details and certifications

Dimension

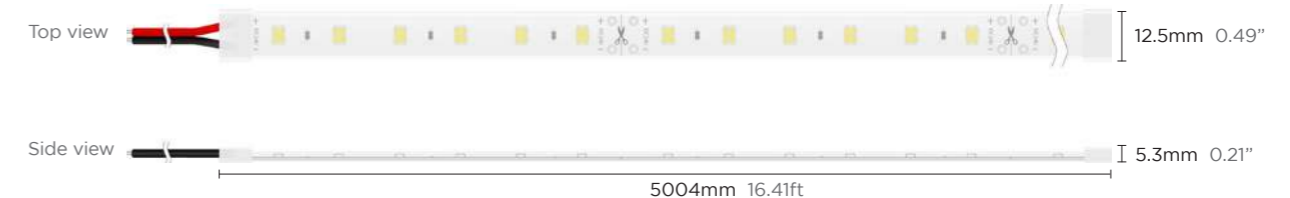

Accessories



A Single Strip Optional Three power

4.8W 725-755lm/m

9.6W 1430-1490lm/m

14.4W 2090-2770lm/m

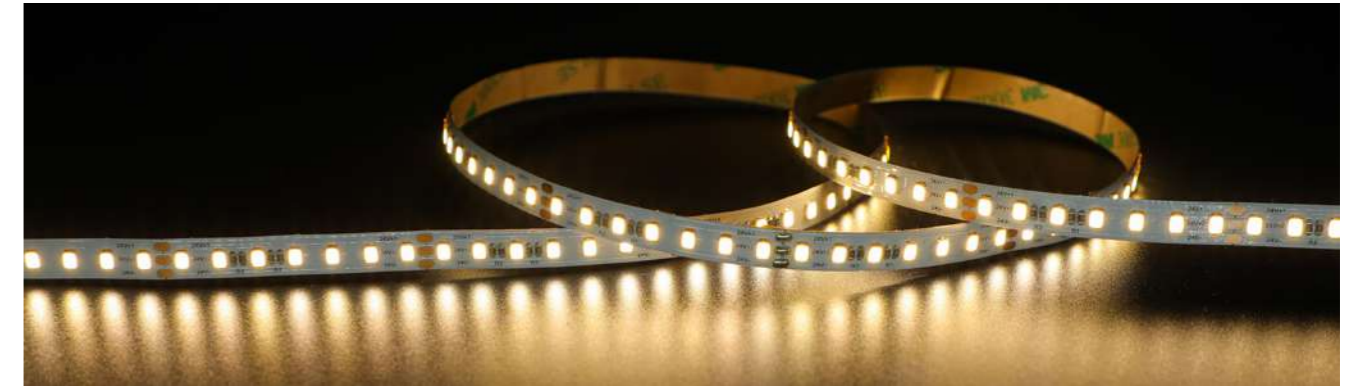

Product NO.

FH14W-PO-G1 28HX8x 24V140S7 W08L05



Technical Details

Power	Options available	4.8W / 9.6W / 14.4W	Power	LM
Voltage	DC24V		4.8W	725-755lm/m 221-230lm/ft
CRI	80		9.6W	1430-1490lm/m 436-454lm/ft
Led Qty	140LEDs/M 42LEDs/ft		14.4W	2090-2770lm/m 637-844lm/ft
Length/Reel	5m 16.4ft			
Cutting Length	50mm 1.97"			
IP Grade	IP20			

Note: 'x' (CCT) = "27"(2700K) / "30"(3000K) / "40"(4000K) / "50"(5000K) / "60"(6000K), Please contact us for more information.
* Please contact our sales for the latest details and certifications

Dimension

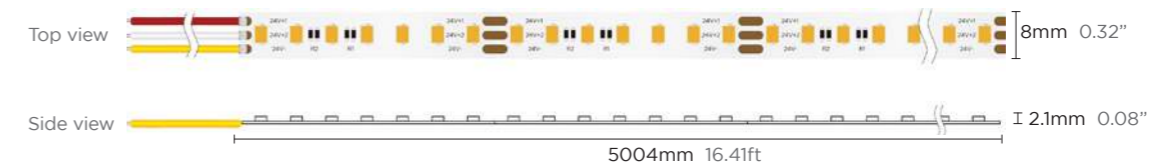

Wiring method



Cabinet LED Strip

Comfortable and uniform light distribution, without “dots”.



The light strip can be cut freely. A width of 6mm can be installed in narrow installation areas such as cabinets.



Product NO.
FE12W-P0-G1 22X9x 24V180S1 W06L05



Technical Details

Power	12W/M 3.65W/ft	Lumens		
Voltage	DC24V/12V	● 2700K	1080lm/m	329lm/ft
CRI	90	● 3000K	1110lm/m	338lm/ft
Led Qty	180LEDs/M 54LEDs/ft	● 4000K	1140lm/m	347lm/ft
Length/Reel	5m 32.8ft	● 5000K	1140lm/m	347lm/ft
Cutting Length	1LED 1 Cut 5.55mm	● 6000K	1140lm/m	347lm/ft
IP Grade	IP68			

Note: 'x' (CCT) = *27*(2700K) / *30*(3000K) / *40*(4000K) / *50*(5000K) / *60*(6000K), Please contact us for more information.
* Please contact our sales for the latest details and certifications

Dimension

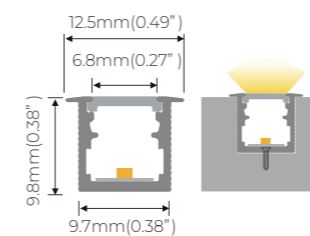
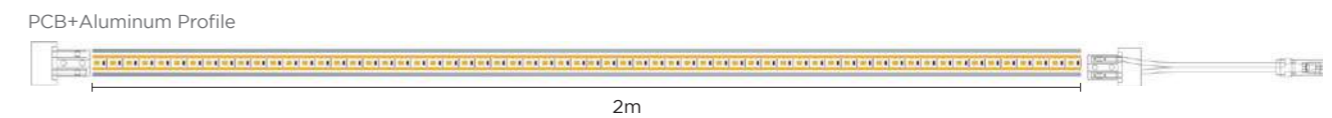
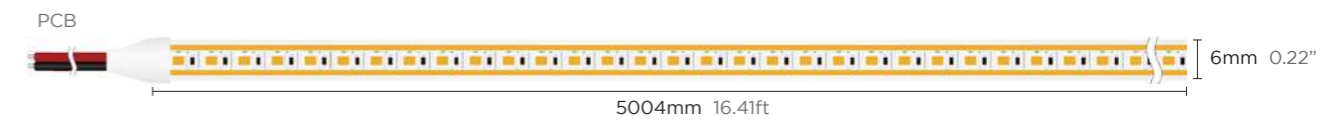

Multi-row strip

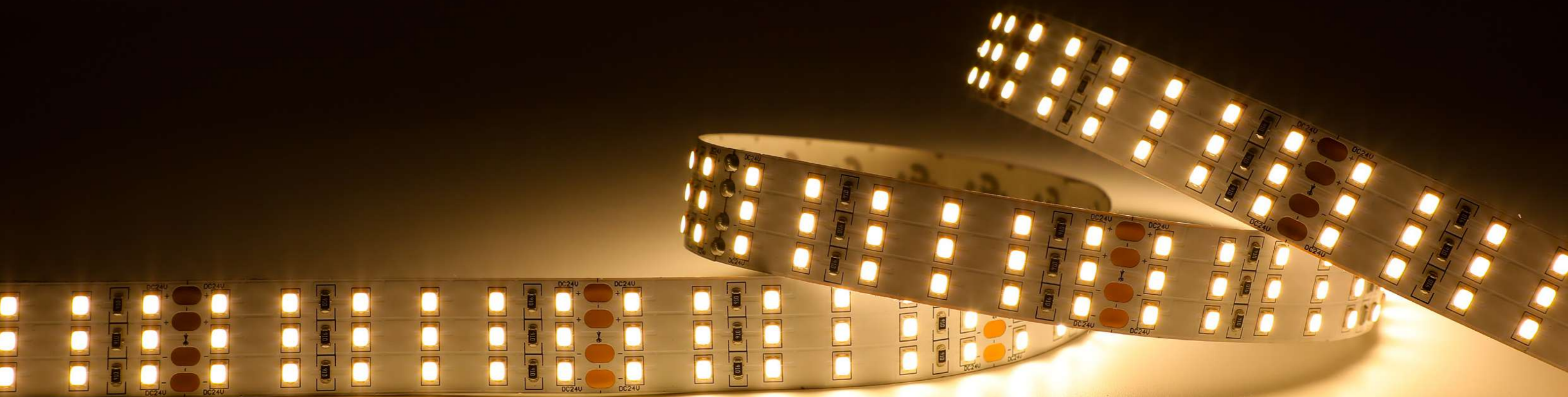

Double-row strip

Can meet different color temperature requirements.
The matched color control system can achieve uniform color temperature and brightness adjustm.



240LEDs/M 19.2W 24V

Product NO.
FH19W-PO-G1 28LX8x 24V240D12 W15L05



Technical Details

Power	19.2W/M 5.85W/ft	Lumens	
Voltage	DC24V	● 2700K	1920lm/m 585lm/ft
CRI	80	● 3000K	2015lm/m 614lm/ft
Led Qty	240LEDs/M 73LEDs/ft	● 4000K	2110lm/m 643lm/ft
Length/Reel	5004mm 16.41ft	● 5000K	2110lm/m 643lm/ft
Cutting Length	50mm 1.97'	● 6000K	2110lm/m 643lm/ft
IP Grade	IP20		

Note:'x' (CCT) = "27"(2700K) / "30"(3000K) / "40"(4000K) / "50"(5000K) / "60"(6000K), Please contact us for more information.
* Please contact our sales for the latest details and certifications

Dimension

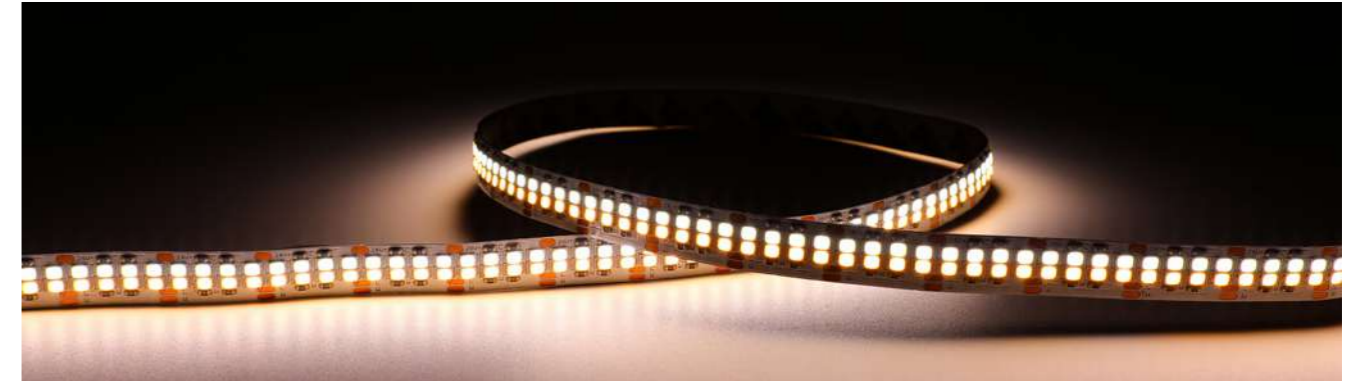
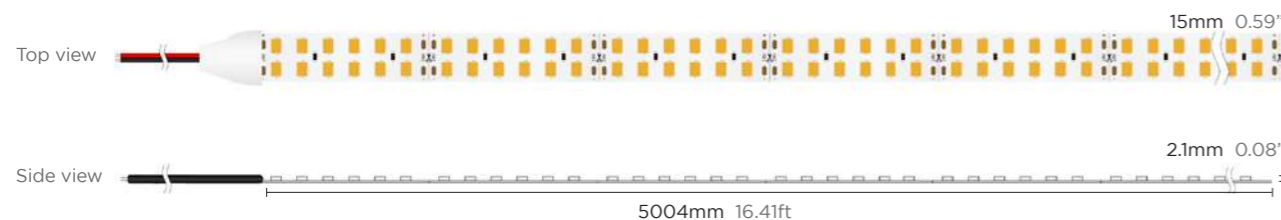

Can meet different color temperature requirements.
The matched color control system can achieve uniform color temperature and brightness adjustm.
Ultra-high efficiency, up to 150lm/w, more energy-saving.
Mini cut, 20mm cut length

400LEDs/M 19.2W 24V / Tunable CCT

Product NO.
FH19C-PO-G1 28BL92428BL960 24V400D8 W12L05



Technical Details

Power	19.2W/M 5.85W/ft	Lumens	
Voltage	DC24V	● 2400K	1260lm/m 384lm/ft
CRI	80	● 6000K	1440lm/m 439lm/ft
Led Qty	400LEDs/M 122LEDs/ft		
Length/Reel	5004mm 16.41ft		
Cutting Length	20mm 0.79'		
IP Grade	IP20		

Note:'x' (CCT) = "27"(2700K) / "30"(3000K) / "40"(4000K) / "50"(5000K) / "60"(6000K), Please contact us for more information.
* Please contact our sales for the latest details and certifications

Dimension

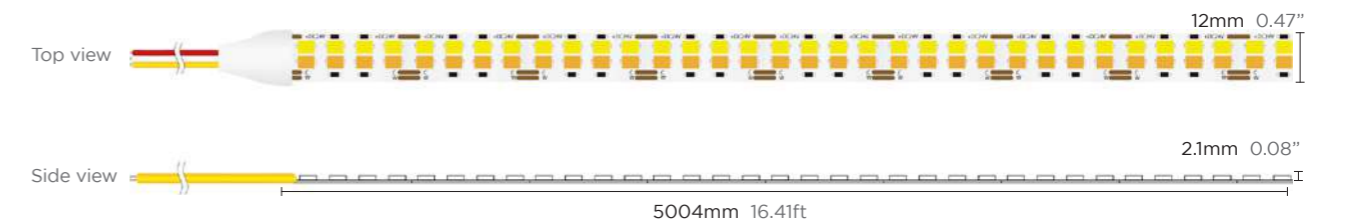

Multi-row strip

7 led/group design.
 Ultra-high efficiency, up to 145lm/w, more energy-saving.
 Power up to 27W/M, 5 meters without voltage drop.
 feed power in one side.

546LEDs/M 27W 24V

Product NO.

FH27W-PO-G1 28BL9x 24V546T21 W30L05



Technical Details

Power	27W/M 8.23W/ft	Lumens		
Voltage	DC24V	● 2700K	3375lm/m	1029lm/ft
CRI	90	● 3000K	3590lm/m	1094lm/ft
Led Qty	546LEDs/M 166LEDs/ft	● 4000K	3885lm/m	1184lm/ft
Length/Reel	5004mm 16.41ft	● 5000K	3885lm/m	1184lm/ft
Cutting Length	38.5mm 1.51'	● 6000K	3885lm/m	1184lm/ft
IP Grade	IP20			

Note: 'x' (CCT) = "27"(2700K) / "30"(3000K) / "40"(4000K) / "50"(5000K) / "60"(6000K). Please contact us for more information.
 * Please contact our sales for the latest details and certifications

Dimension

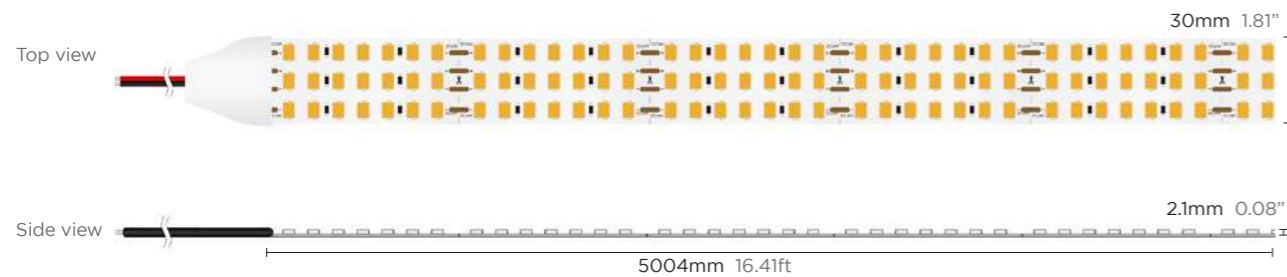

High CRI; CRI>90.
 High color consistency, within 5 steps SDCM (3 steps Optional).
 Power up to 40W/M, 5 meters without voltage drop feed power in one side.

252LEDs/M 40W 24V

Product NO.

FH40W-PO-G1 28HZ9x 24V252T18 W20L05



Technical Details

Power	40W/M 12.1W/ft	Lumens		
Voltage	DC24V	● 2700K	3400lm/m	1036lm/ft
CRI	90	● 3000K	3600lm/m	1097lm/ft
Led Qty	252LEDs/M 77LEDs/ft	● 4000K	3800lm/m	1158lm/ft
Length/Reel	5004mm 16.41ft	● 5000K	3800lm/m	1158lm/ft
Cutting Length	71.4mm 2.81"	● 6000K	3800lm/m	1158lm/ft
IP Grade	IP20			

Note: 'x' (CCT) = "27"(2700K) / "30"(3000K) / "40"(4000K) / "50"(5000K) / "60"(6000K). Please contact us for more information.
 * Please contact our sales for the latest details and certifications

Dimension

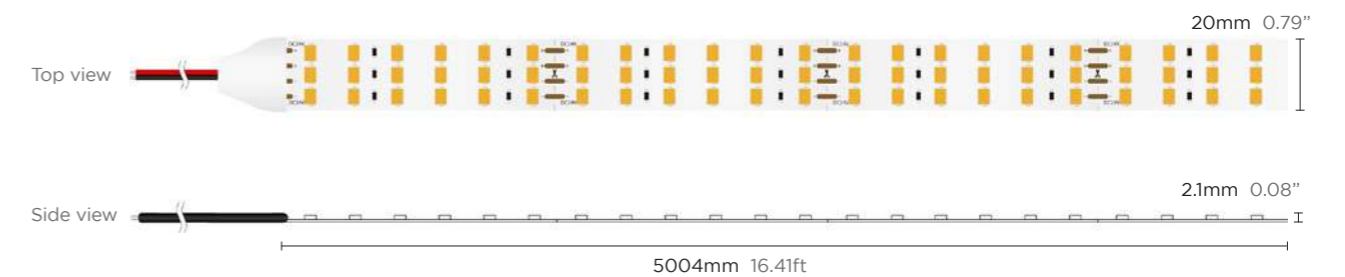

CRI 98 / 95 Series



CRI 98

Lower harmful blue light, good for visual organs. High optical saturation level, Rg>100 to get vivid color. Closer to the natural light spectrum, healthy lighting is preferred.

70LEDs/M 9.6W 24V

Product NO.
FP10W-PO-G1 28HVX 24VT70S W08L05



Technical Details

Power	9.6W/M 2.93W/ft	Lumens		ErP Class									
Voltage	DC24V	● 2700K	760lm/m 231lm/ft	● 3000K	780lm/m 237lm/ft	● 4000K	800lm/m 243lm/ft	● 5000K	788lm/m 240lm/ft	● 6000K	780lm/m 237lm/ft	ErP Class	G
CRI	98												G
Led Qty	70LEDs/M 21LEDs/ft												G
Length/Reel	5004mm 16.41ft												G
Cutting Length	100mm 3.93"												G
IP Grade	IP20												G

Note: 'x' (CCT) = "27"(2700K) / "30"(3000K) / "40"(4000K) / "50"(5000K) / "60"(6000K), Please contact us for more information.
* Please contact our sales for the latest details and certifications

Dimension

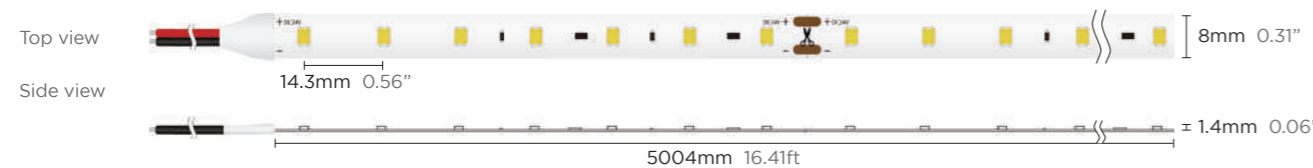

Connectors List



* Please Go to page 248 for Accessory and Connector Usage Guidelines.

140LEDs/M 19.2W 24V

Product NO. FP19W-PO-G1 28HVX 24VT140S W10L05



Technical Details

Power	19.2W/M 5.85W/ft	Lumens		ErP Class									
Voltage	DC24V	● 2700K	1530lm/m 466lm/ft	● 3000K	1550lm/m 472lm/ft	● 4000K	1620lm/m 493lm/ft	● 5000K	1580lm/m 481lm/ft	● 6000K	1550lm/m 472lm/ft	ErP Class	G
CRI	98												G
Led Qty	140LEDs/M 42LEDs/ft												G
Length/Reel	5004mm 16.41ft												G
Cutting Length	50mm 1.97"												G
IP Grade	IP20												G

Note: 'x' (CCT) = "27"(2700K) / "30"(3000K) / "40"(4000K) / "50"(5000K) / "60"(6000K), Please contact us for more information.
* Please contact our sales for the latest details and certifications

Dimension

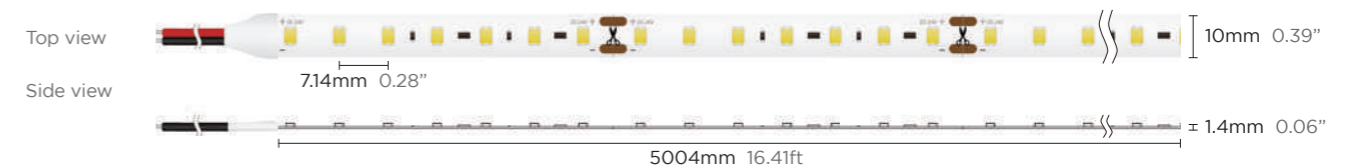

Connectors List



* Please Go to page 248 for Accessory and Connector Usage Guidelines.

CRI 95

With the super-high color rendering performance of CRI>95 and the good cost-effective, High fitting with solar spectrum, high color reducibility, the color of irradiated object closer to under natural light. Rf > 95; high color saturation, Rg > 100; lower harmful blue light, healthy lighting.

60LEDs/M 4.8W 24V

Product NO.
FH05W-PO-G1 28LSFX 24V60S W08L05



Technical Details

Power	4.8W/M 1.46W/ft	Lumens			ErP Class
Voltage	DC24V	● 2400K	360lm/m	110lm/ft	G
CRI	95	● 2700K	370lm/m	113lm/ft	G
Led Qty	60LEDs/M 18LEDs/ft	● 3000K	384lm/m	117lm/ft	G
Length/Reel	5004mm 16.41ft	● 4000K	394lm/m	120lm/ft	G
Cutting Length	100mm 3.93"	● 5000K	413lm/m	126lm/ft	
IP Grade	IP20 / IP62 / IP65 / IP68	● 6000K	384lm/m	117lm/ft	

Note:'x' (CCT) = "27"(2700K) / "30"(3000K) / "40"(4000K) / "50"(5000K) / "60"(6000K), Please contact us for more information.

* Please contact our sales for the latest details and certifications

Dimension

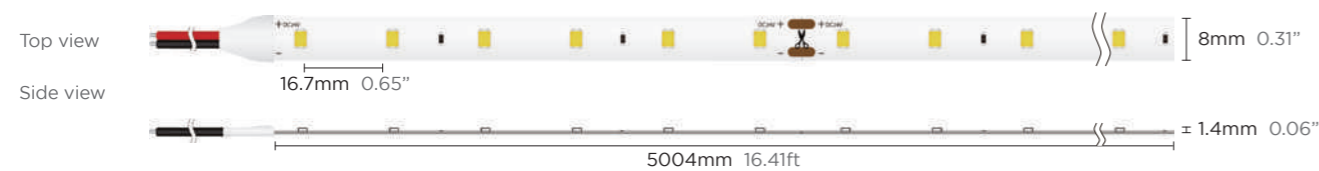

Connectors List



* Please Go to page 248 for Accessory and Connector Usage Guidelines.

60LEDs/M 10W 24V

Product NO. FH10W-PO-G1 28HSFX 24V60S W08L05



Technical Details

Power	10W/M 3.05W/ft	Lumens			ErP Class
Voltage	DC24V	● 2400K	750lm/m	229lm/ft	G
CRI	95	● 2700K	770lm/m	235lm/ft	G
Led Qty	60LEDs/M 18LEDs/ft	● 3000K	800lm/m	244lm/ft	G
Length/Reel	5004mm 16.41ft	● 4000K	820lm/m	250lm/ft	G
Cutting Length	100mm 3.93"	● 5000K	860lm/m	262lm/ft	
IP Grade	IP20 / IP62 / IP65 / IP68	● 6000K	800lm/m	244lm/ft	

Note:'x' (CCT) = "27"(2700K) / "30"(3000K) / "40"(4000K) / "50"(5000K) / "60"(6000K), Please contact us for more information.

* Please contact our sales for the latest details and certifications

Dimension

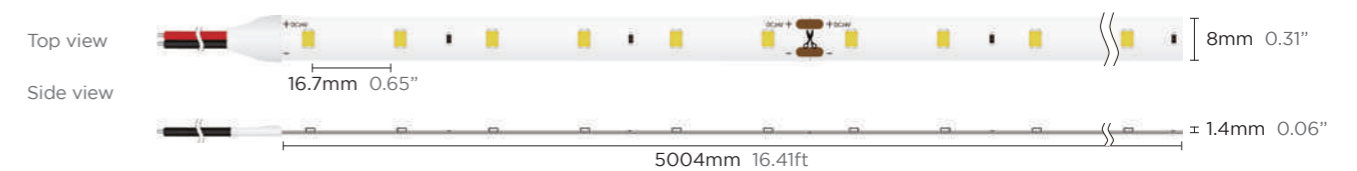

Connectors List



* Please Go to page 248 for Accessory and Connector Usage Guidelines.

CRI 95

120LEDs/M 9.6W 24V

Product NO. FH10W-P0-G1 28LSFX 24V120S W08L05



Technical Details

Power	9.6W/M 2.93W/ft	Lumens		ErP Class	
Voltage	DC24V	● 2400K	720lm/m 220lm/ft		G
CRI	95	● 2700K	739lm/m 225lm/ft		G
Led Qty	120LEDs/M 36LEDs/ft	● 3000K	768lm/m 234lm/ft		G
Length/Reel	5004mm 16.41ft	● 4000K	787lm/m 240lm/ft		G
Cutting Length	50mm 1.97"	● 5000K	785lm/m 239lm/ft		G
IP Grade	IP20 / IP62 / IP65 / IP68	● 6000K	768lm/m 234lm/ft		G

Note: 'x' (CCT) = "27"(2700K) / "30"(3000K) / "40"(4000K) / "50"(5000K) / "60"(6000K). Please contact us for more information.

* Please contact our sales for the latest details and certifications

Dimension

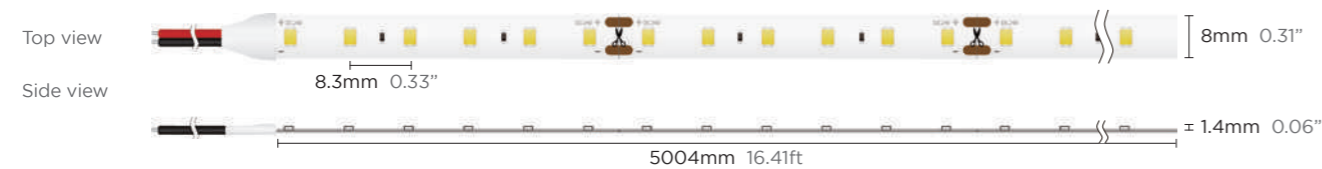

Connectors List



* Please Go to page 248 for Accessory and Connector Usage Guidelines.

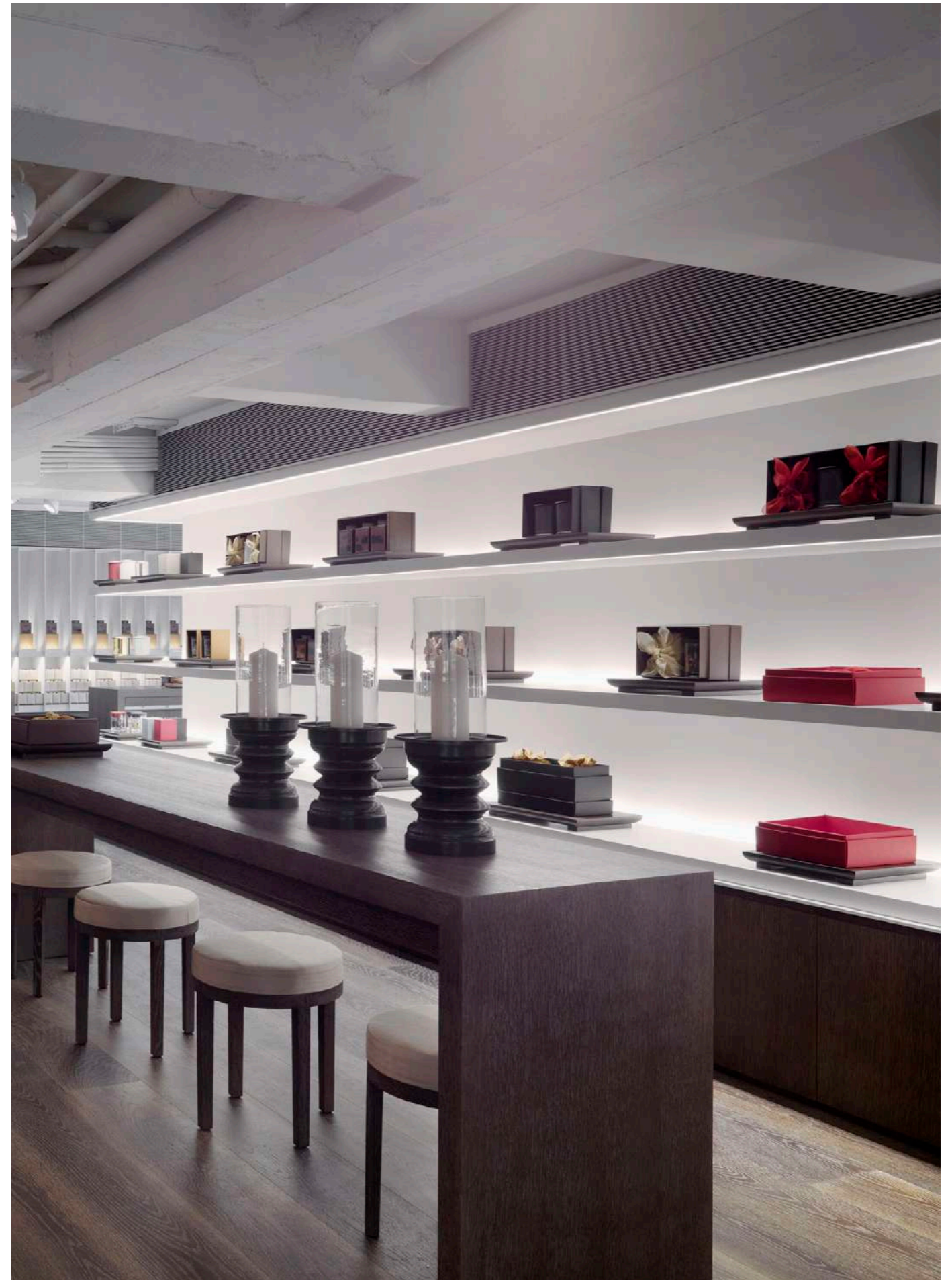

Colorful Series

The atmosphere is inseparable from colors.
Provides better options for various venues.
Indirect installation of linear lighting also makes the environment more concise
and can better reflect the atmosphere of the environment.

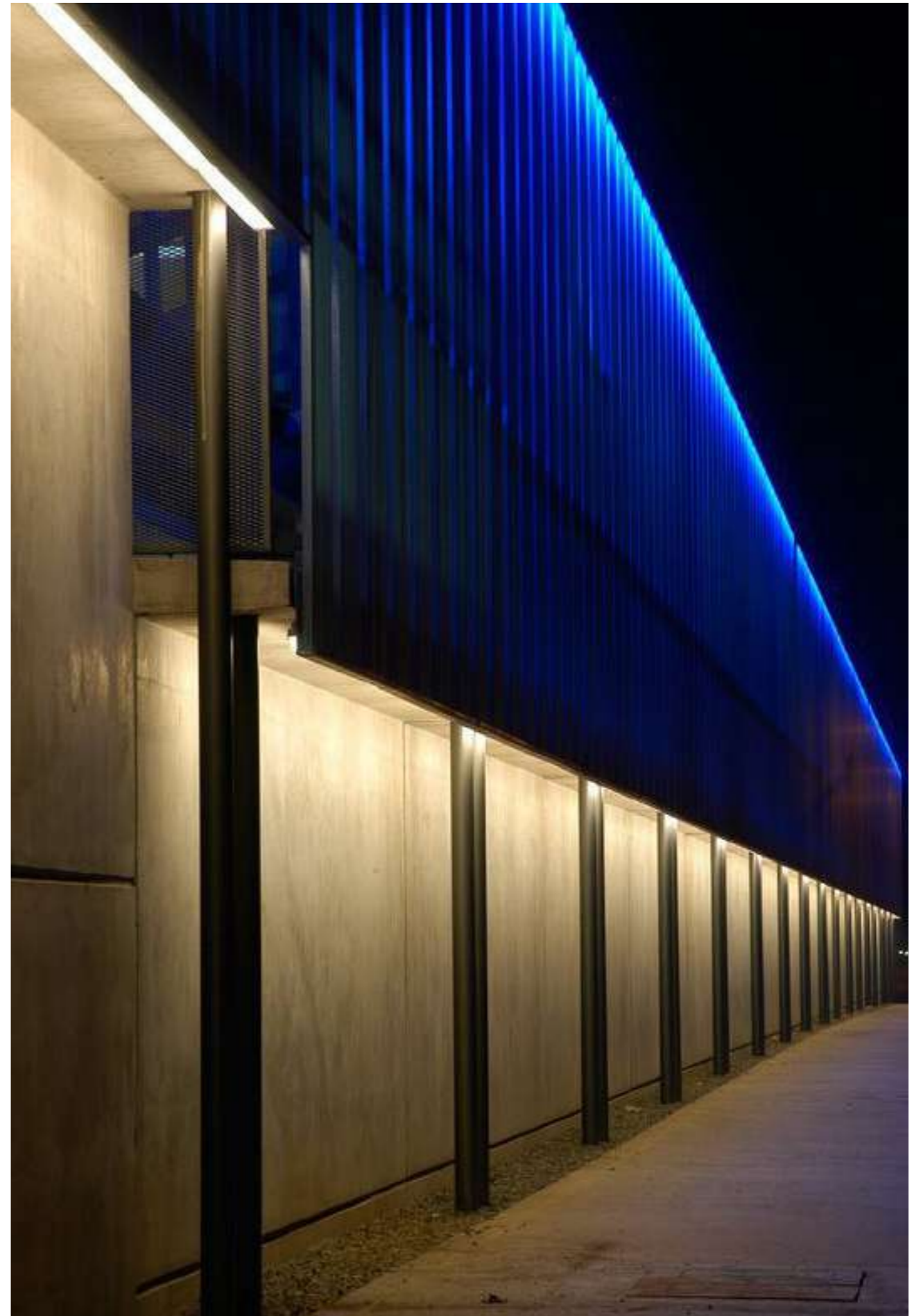
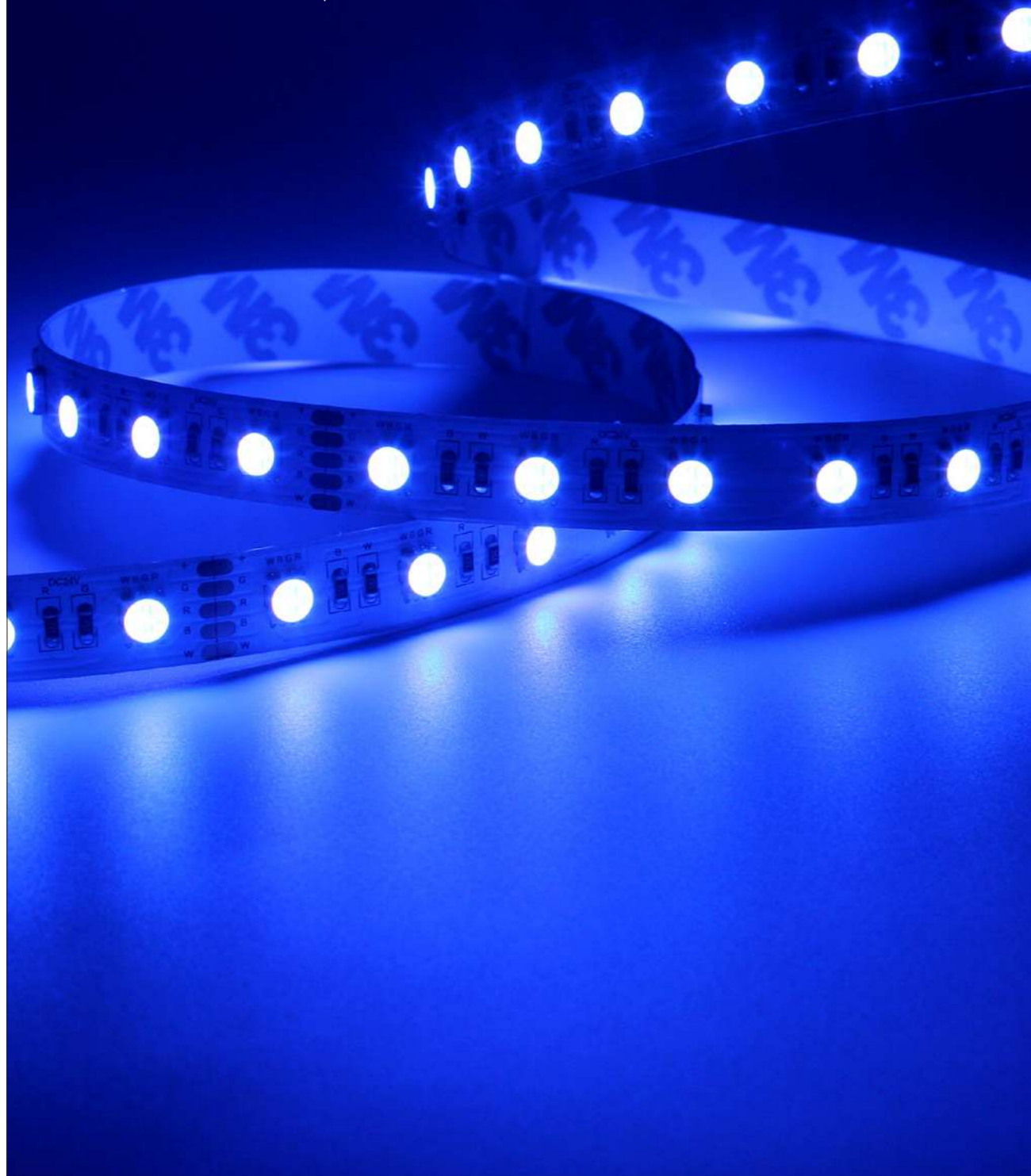

Tunable CCT / 5050 SMD

60LEDS/M 14.4W

Product NO. FE14C-PO-G1 50Z8xx 24V60S W10L05



Can meet different color temperature requirements. Integrated package solution for more uniform and consistent light mixing. The matched color control system can achieve uniform color temperature and brightness adjustment.

2700K + 6000K

IP Grade



Technical Details

Power	14.4W/M 4.39W/ft
Voltage	DC24V
CRI	80
Led Qty	60LEDS/M 18LEDS/ft
Color Temperature	● 2700K ○ 6000K
Lumens	640lm 195lm/ft 680lm 207lm/ft
Length/Reel	5M 16.41ft
Cutting Length	100mm 3.94"
IP Grade	IP20/IP62/IP65/IP67/IP68

Note: 'x' (CCT) = "27"(2700K) / "30"(3000K) / "40"(4000K) / "50"(5000K) / "60"(6000K), Please contact us for more information.
 ※ Please contact our sales for the latest details and certifications

Dimension

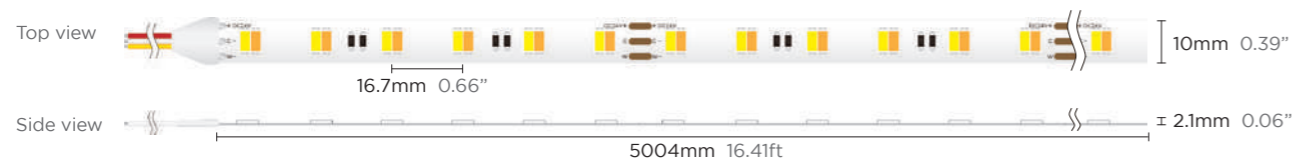

Connectors List



※ Please Go to page 248 for Accessory and Connector Usage Guidelines.

Tunable CCT / 5050 SMD

60LEDS/M 14.4W

Product NO. FH14C-PO-G1 50HZ9x50HZ9x 24V60S W10L05



Can meet different color temperature requirements. The matched color control system can achieve uniform color temperature and brightness adjustment.

2700K + 6000K

IP Grade



Technical Details

Power	14.4W/M 4.39W/ft
Voltage	DC24V
CRI	90
Led Qty	60LEDS/M 18LEDS/ft
Color Temperature	● 2700K ○ 6000K
Lumens	620lm 189lm/ft 660lm 201lm/ft
Length/Reel	5M 16.41ft
Cutting Length	66.7mm 2.63"
IP Grade	IP20/IP62/IP65/IP67/IP68

Note: 'x' (CCT) = "27"(2700K) / "30"(3000K) / "40"(4000K) / "50"(5000K) / "60"(6000K), Please contact us for more information.
 ※ Please contact our sales for the latest details and certifications

Dimension

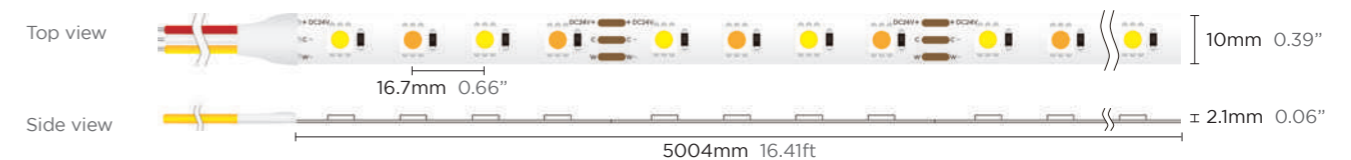

Connectors List



※ Please Go to page 248 for Accessory and Connector Usage Guidelines.

Tunable CCT / 3527 SMD

120LEDS/M 19.2W

Product NO. FE19C-P0-G1 27Z8xx 24V120S W10L05



Can meet different color temperature requirements.
Integrated package solution for more uniform and consistent light mixing.
The matched color control system can achieve uniform color temperature and brightness adjustment.

2700K + 6000K

IP Grade



Technical Details

Power	19.2W/M 5.85W/ft
Voltage	DC24V
CRI	80
Led Qty	120LEDS/M 36LEDS/ft
Color Temperature	● 2700K ○ 6000K
Lumens	760lm 232lm/ft 800lm 244lm/ft
Length/Reel	5M 16.41ft
Cutting Length	50mm 1.97"
IP Grade	IP20/IP62/IP65/IP67/IP68

Note: 'x' (CCT) = "27"(2700K) / "30"(3000K) / "40"(4000K) / "50"(5000K) / "60"(6000K), Please contact us for more information.
* Please contact our sales for the latest details and certifications

Dimension



Connectors List



* Please Go to page 248 for Accessory and Connector Usage Guidelines.

Tunable CCT / 2835 SMD

120LEDS/M 19.2W

Product NO. FH19C-P0-G1 28HZ9x28HZ9x 24V120S W10L05



Can meet different color temperature requirements.
The matched color control system can achieve uniform color temperature and brightness adjustment.

2700K + 6000K

IP Grade



Technical Details

Power	19.2W/M 5.85W/ft
Voltage	DC24V
CRI	90
Led Qty	120LEDS/M 36LEDS/ft
Color Temperature	● 2700K ○ 6000K
Lumens	880lm 268lm/ft 960lm 293lm/ft
Length/Reel	5M 16.41ft
Cutting Length	100mm 3.94"
IP Grade	IP20/IP62/IP65/IP67/IP68

Note: 'x' (CCT) = "27"(2700K) / "30"(3000K) / "40"(4000K) / "50"(5000K) / "60"(6000K), Please contact us for more information.
* Please contact our sales for the latest details and certifications

Dimension

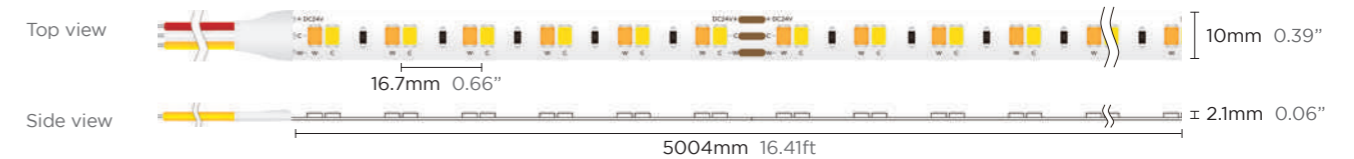

Connectors List



* Please Go to page 248 for Accessory and Connector Usage Guidelines.

RGB / 3838 SMD

120LEDS/M 9.6W

Product NO. FE10C-P0-G1 38XRGB 24V120S W05L2D5



Integrated RGB three-color light-emitting chip, bright and pure color.
High density layout, uniform light mixing effect.
5mm width PCB, available for slim space.



IP Grade



Technical Details

Power	9.6W/M 2.93W/ft					
Voltage	DC24V					
CRI	-					
Led Qty	120LEDs/M 36LEDs/ft					
Color Temperature	●R	●G	●B			
Lumens	615-625nm 84lm/m 26lm/ft	520-530nm 384lm/m 117lm/ft	460-470nm 76lm/m 23lm/ft			
Length/Reel	2504mm 8.22ft					
Cutting Length	50mm 1.97"					
IP Grade	IP20/IP65					

Note:'x' (CCT) = "27"(2700K) / "30"(3000K) / "40"(4000K) / "50"(5000K) / "60"(6000K), Please contact us for more information.
* Please contact our sales for the latest details and certifications

Dimension

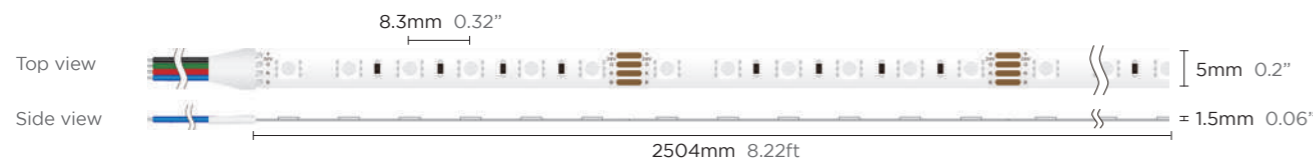

Connectors List



* Please Go to page 248 for Accessory and Connector Usage Guidelines.

RGB / 3838 SMD

120LEDS/M 14.4W

Product NO. FE14C-P0-G1 38XRGB 24V120S W08L05



Integrated RGB three-color light-emitting chip, bright and pure color.
High density layout, uniform light mixing effect.
Adapt all kinds of controllers for colorful light.



IP Grade

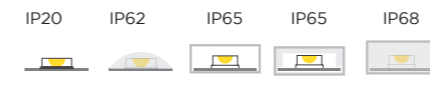

Technical Details

Power	14.4W/M 4.39W/ft					
Voltage	DC24V					
CRI	-					
Led Qty	120LEDs/M 36LEDs/ft					
Color Temperature	●R	●G	●B			
Lumens	615-625nm 120lm/m 37lm/ft	520-530nm 475lm/m 145lm/ft	460-470nm 98lm/m 30lm/ft			
Length/Reel	5M 16.41ft					
Cutting Length	50mm 1.97"					
IP Grade	IP20/IP62/IP65/IP67/IP68					

Note:'x' (CCT) = "27"(2700K) / "30"(3000K) / "40"(4000K) / "50"(5000K) / "60"(6000K), Please contact us for more information.
* Please contact our sales for the latest details and certifications

Dimension

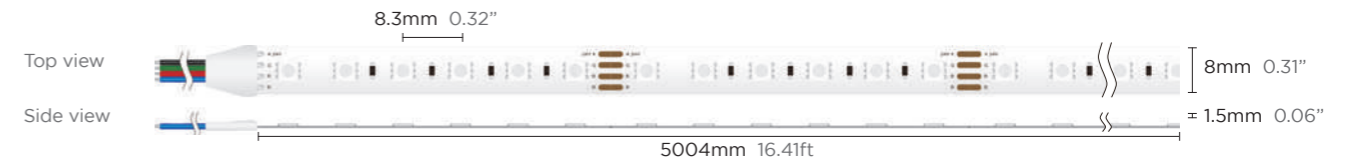

Connectors List



* Please Go to page 248 for Accessory and Connector Usage Guidelines.

RGB / 3838 SMD

144LEDS/M 14.4W

Product NO. FE14C-P0-G1 38XRGB 24V144S W10L05



High density layout 144 Leds/m, uniform light mixing effect, dot-free light.
Adapt all kinds of controllers for colorful light.



IP Grade



Technical Details

Power	14.4W/M 4.39W/ft
Voltage	DC24V
CRI	-
Led Qty	144LEDS/M 44LEDS/ft
Color Temperature	●R ●G ●B
Lumens	615-625nm 124lm/m 38lm/ft 520-530nm 512lm/m 156lm/ft 460-470nm 103lm/m 31lm/ft
Length/Reel	5M 16.41ft
Cutting Length	41.7mm 1.64"
IP Grade	IP20/IP62/IP65/IP67/IP68

Note:'x' (CCT) =27°(2700K) / 30°(3000K) / 40°(4000K) / 50°(5000K) / 60°(6000K), Please contact us for more information.
* Please contact our sales for the latest details and certifications

Dimension

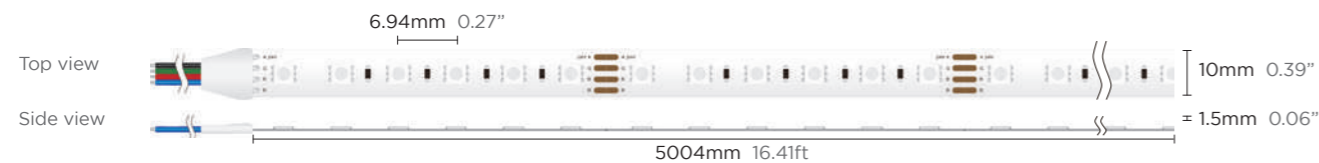

Connectors List



* Please Go to page 248 for Accessory and Connector Usage Guidelines.

RGB / 5050 SMD

30LEDS/M 7.2W

Product NO. FH07C-P0-G1 50ZRGB 24V30S W10L05



Self-packing RGB, with high consistency of wavelength, bright and pure color.
The overall color jump and gradient can be realized by the controlled.



IP Grade

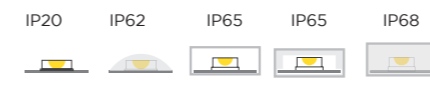

Technical Details

Power	7.2W/M 2.19W/ft
Voltage	DC24V
CRI	-
Led Qty	30LEDS/M 9LEDS/ft
Color Temperature	●R ●G ●B
Lumens	615-625nm 60lm/m 18lm/ft 520-530nm 150lm/m 45lm/ft 460-470nm 40lm/m 12lm/ft
Length/Reel	5M 16.41ft
Cutting Length	166.7mm 6.56"
IP Grade	IP20/IP62/IP65/IP67/IP68

Note:'x' (CCT) =27°(2700K) / 30°(3000K) / 40°(4000K) / 50°(5000K) / 60°(6000K), Please contact us for more information.
* Please contact our sales for the latest details and certifications

Dimension

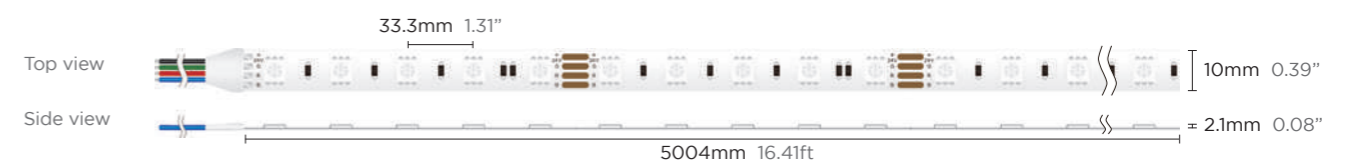

Connectors List



* Please Go to page 248 for Accessory and Connector Usage Guidelines.

RGB / 5050SMD

60LEDS/M 14.4W

Product NO. FH14C-P0-G1 50ZRGB 24V60S W10L05



Self-packing RGB, with high consistency of wavelength, bright and pure color. The overall color jump and gradient can be realized by the controlled.



IP Grade

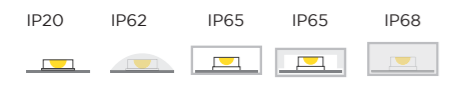

Technical Details

Power	14.4W/M 4.39W/ft
Voltage	DC24V
CRI	-
Led Qty	60LEDS/M 18LEDS/ft
Color Temperature	●R ●G ●B
Lumens	130lm/m 40lm/ft 330lm/m 101lm/ft 70lm/m 21lm/ft
Length/Reel	5M 16.41ft
Cutting Length	100mm 3.94"
IP Grade	IP20/IP62/IP65/IP67/IP68

Note:'x' (CCT) =27"(2700K) / "30"(3000K) / "40"(4000K) / "50"(5000K) / "60"(6000K), Please contact us for more information.
* Please contact our sales for the latest details and certifications

Dimension



Connectors List



* Please Go to page 248 for Accessory and Connector Usage Guidelines.

2835 SMD / RGB

70LEDS/M 7.2W

Product NO. FE07C-P0-G1 28XRGB 24V70S7 W08L05



High-quality 2835 LED beads are used, with low power consumption and high brightness. The light is evenly distributed and cost-effective. Paired with connectors and profiles, installation is quick and easy, creating more scene applications.



IP Grade



Technical Details

Power	7.2W/M 2.19W/ft
Voltage	DC24V
CRI	-
Led Qty	70LEDS/M 9LEDS/ft
Color Temperature	●R ●G ●B
Lumens	615-625nm 85lm/m 26lm/ft 520-530nm 235lm/m 72lm/ft 460-470nm 45lm/m 14lm/ft
Length/Reel	5M 16.41ft
Cutting Length	100mm 3.94"
IP Grade	IP20/IP62/IP65/IP67/IP68

Note:'x' (CCT) =27"(2700K) / "30"(3000K) / "40"(4000K) / "50"(5000K) / "60"(6000K), Please contact us for more information.
* Please contact our sales for the latest details and certifications

Dimension

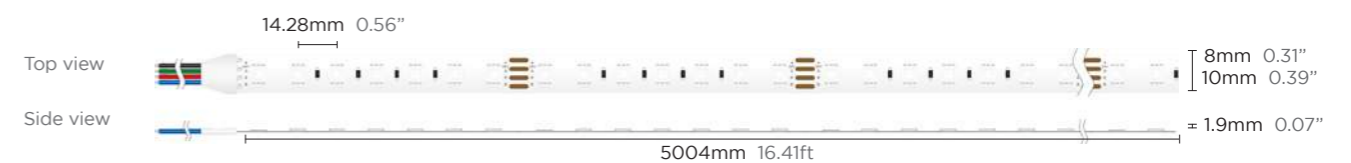

Connectors List



* Please Go to page 248 for Accessory and Connector Usage Guidelines.

2835 SMD / RGB

140LEDS/M 12W

Product NO. FE12C-P0-G1 28XRGB 24V140S7 W08L05



Self-packing RGB, with high consistency of wavelength, bright and pure color.
The overall color jump and gradient can be realized by the controlled.



IP Grade

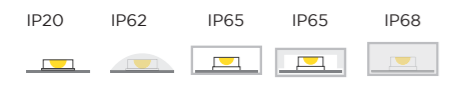

Technical Details

Power	12W/M 3.66W/ft
Voltage	DC24V
CRI	-
Led Qty	140LEDs/M 42LEDs/ft
Color Temperature	●R ●G ●B
Lumens	615-625nm 135lm/m 41lm/ft 520-530nm 440lm/m 134lm/ft 460-470nm 88lm/m 27lm/ft
Length/Reel	5M 16.41ft
Cutting Length	50mm 1.97"
IP Grade	IP20/IP62/IP65/IP67/IP68

Note:'x' (CCT) =27°(2700K) / 30°(3000K) / 40°(4000K) / 50°(5000K) / 60°(6000K), Please contact us for more information.
* Please contact our sales for the latest details and certifications

Dimension

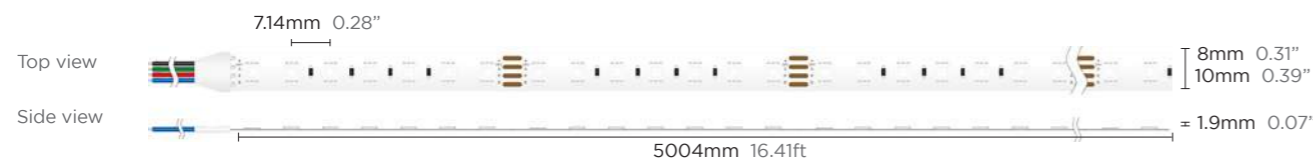

Connectors List



* Please Go to page 248 for Accessory and Connector Usage Guidelines.

2835 SMD / RGB

182LEDS/M 15W

Product NO. FE15C-P0-G1 28XRGB 24V182S7 W12L05



High-quality 2835 LED beads are used, with low power consumption and high brightness.
The light is evenly distributed and cost-effective.
Paired with connectors and profiles, installation is quick and easy, creating more scene applications.



IP Grade



Technical Details

Power	15W/M 4.57W/ft
Voltage	DC24V
CRI	-
Led Qty	182LEDs/M 55LEDs/ft
Color Temperature	●R ●G ●B
Lumens	615-625nm 160lm/m 49lm/ft 520-530nm 630lm/m 192lm/ft 460-470nm 115lm/m 35lm/ft
Length/Reel	5M 16.41ft
Cutting Length	38.5mm 1.52"
IP Grade	IP20/IP62/IP65/IP67/IP68

Note:'x' (CCT) =27°(2700K) / 30°(3000K) / 40°(4000K) / 50°(5000K) / 60°(6000K), Please contact us for more information.
* Please contact our sales for the latest details and certifications

Dimension

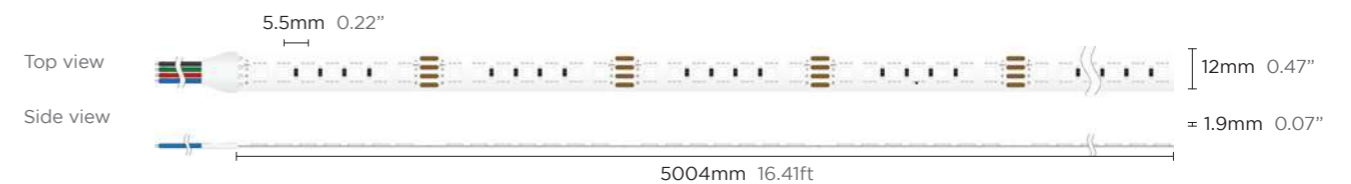

Connectors List



* Please Go to page 248 for Accessory and Connector Usage Guidelines.

Multiple Color / RGBW / 3527 SMD
120LEDS/M 19.2W

Product NO. FE19C-P0-G1 27ZRG27ZB8x 24V120S W10L05



Can achieve a variety of colors including white ,and improve color index and consistency for white lights. Integrated package solution for more uniform and consistent light mixing.



IP Grade



Technical Details

Power	19.2W/M 5.85W/ft
Voltage	DC24V
CRI	80
Led Qty	120LEDS/M 36LEDs/ft
Length/Reel	5M 16.41ft
Cutting Length	100mm 3.94"
IP Grade	IP20/IP62/IP65/IP67/IP68

Lumens

Color Temperature			
● Red	615-625nm	130lm/m	40lm/ft
● Green	520-530nm	330lm/m	30lm/ft
● Blue	460-470nm	70lm/m	32lm/ft
○ White			
● 2400K		310lm/m	95lm/ft
● 2700K		320lm/m	98lm/ft
● 3000K		340lm/m	104lm/ft
● 4000K		360lm/m	110lm/ft
● 5000K		400lm/m	122lm/ft
● 6000K		380lm/m	116lm/ft

Note:'x' (CCT) = "27"(2700K) / "30"(3000K) / "40"(4000K) / "50"(5000K) / "60"(6000K), Please contact us for more information.
* Please contact our sales for the latest details and certifications

Dimension

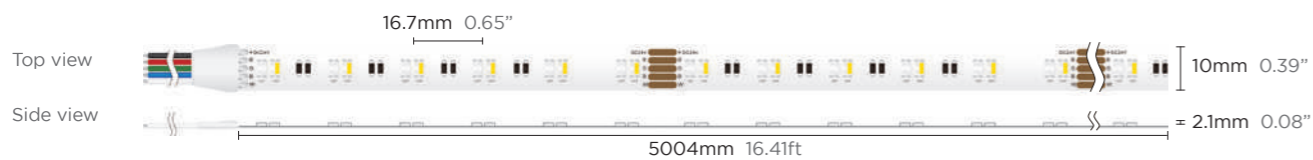

Connectors List



* Please Go to page 248 for Accessory and Connector Usage Guidelines.

Multiple Color / RGBW / 5050 SMD
60LEDS/M 14.4W

Product NO. FH14C-P0-G1 50ZRGB50Z9x 24V60S W12L05



Can achieve a variety of colors including white ,and improve color index and consistency for white lights. Integrated package solution for more uniform and consistent light mixing.



IP Grade

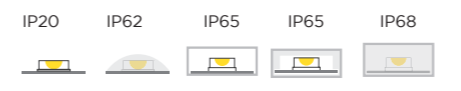

Technical Details

Power	14.4W/M 4.39W/ft
Voltage	DC24V
CRI	90
Led Qty	60LEDS/M 18LEDs/ft
Length/Reel	5M 16.41ft
Cutting Length	200mm 7.87"
IP Grade	IP20/IP62/IP65/IP67/IP68

Lumens

Color Temperature		
● Red	70lm/m	21lm/ft
● Green	160lm/m	49lm/ft
● Blue	40lm/m	12lm/ft
○ White		
● 2400K	540lm/m	165lm/ft
● 2700K	620lm/m	189lm/ft
● 3000K	630lm/m	192lm/ft
● 4000K	710lm/m	216lm/ft
● 5000K	710lm/m	216lm/ft
● 6000K	660lm/m	201lm/ft

Note:'x' (CCT) = "27"(2700K) / "30"(3000K) / "40"(4000K) / "50"(5000K) / "60"(6000K), Please contact us for more information.
* Please contact our sales for the latest details and certifications

Dimension

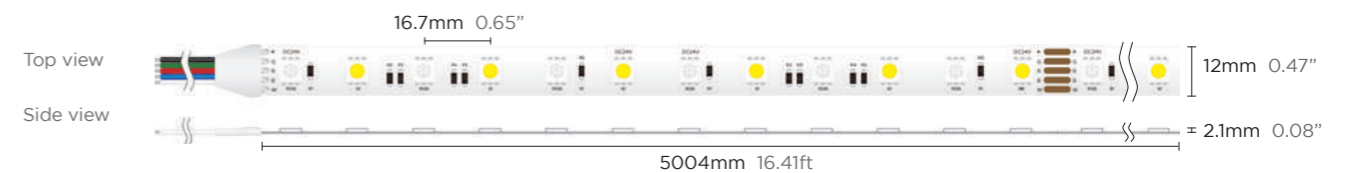

Connectors List



* Please Go to page 248 for Accessory and Connector Usage Guidelines.

Multiple Color / RGBW / 5050 SMD

60LEDS/M 19.2W

Product NO. FE19C-P0-G1 50ZRGB8x 24V60S W12L05



Can meet the requirements of a variety of the white and color light, and improve the color index and consistency for white lights. 4 in 1 integrated package solution could achieve more uniform and consistent mixing light.



IP Grade



Lumens

Color Temperature		
● Red	120lm/m	37lm/ft
● Green	300lm/m	91lm/ft
● Blue	60lm/m	18lm/ft
○ White		
● 2400K	300lm/m	91lm/ft
● 2700K	310lm/m	95lm/ft
● 3000K	330lm/m	101lm/ft
● 4000K	340lm/m	104lm/ft
● 5000K	380lm/m	116lm/ft
● 6000K	360lm/m	110lm/ft

Technical Details

Power	19.2W/M 5.85W/ft
Voltage	DC24V
CRI	80
Led Qty	60LEDS/M 18LEDS/ft
Length/Reel	5M 16.41ft
Cutting Length	100mm 3.94"
IP Grade	IP20/IP62/IP65/IP67/IP68

Note: 'x' (CCT) = "27"(2700K) / "30"(3000K) / "40"(4000K) / "50"(5000K) / "60"(6000K), Please contact us for more information.
* Please contact our sales for the latest details and certifications

Dimension

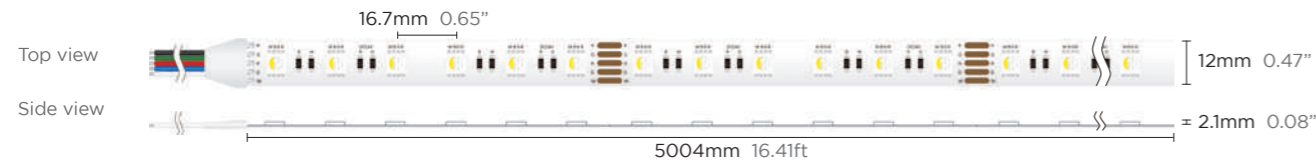

Connectors List



* Please Go to page 248 for Accessory and Connector Usage Guidelines.

Multiple Color / RGBW / 2835&2216 SMD

224LEDS/M 15W

Product NO. FE15C-P0-G1 28XRGB22X940 24V224S14 W12L05



Can meet the requirements of a variety of the white and color light, and improve the color index and consistency for white lights. 4 in 1 integrated package solution could achieve more uniform and consistent mixing light.



IP Grade



Technical Details

Power	15W/M 4.57W/ft
Voltage	DC24V
CRI	90
Led Qty	224LEDS/M 68LEDS/ft
Length/Reel	5M 16.41ft
Cutting Length	62.5mm 2.46"
IP Grade	IP20/IP62/IP65/IP67/IP68

Note: 'x' (CCT) = "27"(2700K) / "30"(3000K) / "40"(4000K) / "50"(5000K) / "60"(6000K), Please contact us for more information.
* Please contact our sales for the latest details and certifications

Dimension

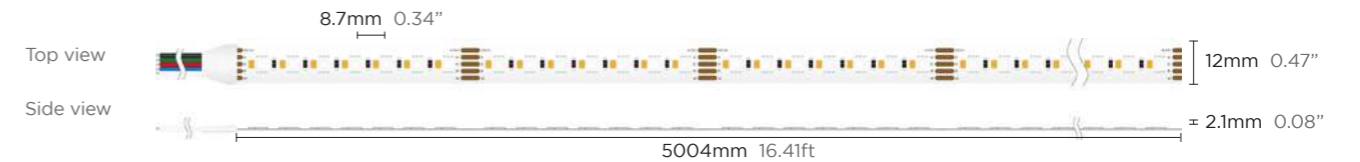

Connectors List



* Please Go to page 248 for Accessory and Connector Usage Guidelines.

Multiple Color / RGBWW / 2835&2216 SMD

210LEDS/M 15W

Product NO. FE15C-P0-G1 28XRGB22X92722X965 24V210S21 W12L05



Can meet the requirements of a variety of the white and color light, and improve the color index and consistency for white lights. 5 in 1 integrated package solution could achieve more uniform and consistent mixing light.



IP Grade



Technical Details

Power	15W/M 4.57W/ft
Voltage	DC24V
CRI	90
Led Qty	210LEDS/M 64LEDS/ft
Length/Reel	5M 16.41ft
Cutting Length	100mm 3.94"
IP Grade	IP20/IP62/IP65/IP67/IP68

Lumens

Color Temperature		
● Red	100lm/m	30lm/ft
● Green	300lm/m	91lm/ft
● Blue	60lm/m	18lm/ft
○ White		
● 2400K	340lm/m	104lm/ft
● 6000K	360lm/m	110lm/ft

Note:'x' (CCT) = "27"(2700K) / "30"(3000K) / "40"(4000K) / "50"(5000K) / "60"(6000K), Please contact us for more information.
* Please contact our sales for the latest details and certifications

Dimension

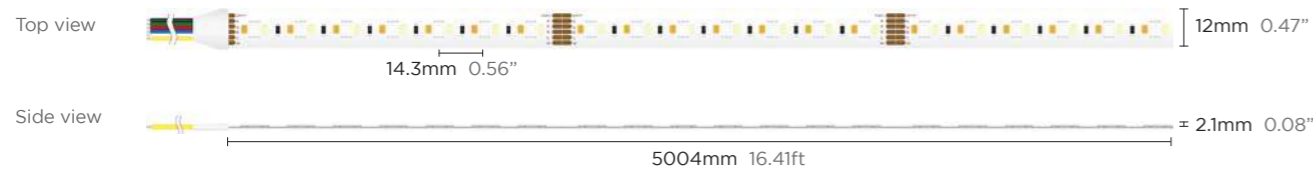

Multiple Color / RGBWW / 5050 SMD

60LEDS/M 24W

Product NO. FE24C-P0-G1 50ZRGB8x 24V60S W12L05



Can meet the requirements of a variety of the white and color light, and improve the color index and consistency for white lights. 5 in 1 integrated package solution could achieve more uniform and consistent mixing light.



IP Grade

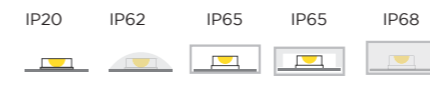

Technical Details

Power	24W/M 7.32W/ft
Voltage	DC24V
CRI	80
Led Qty	60LEDS/M 18LEDS/ft
Length/Reel	5M 16.41ft
Cutting Length	200mm 7.87"
IP Grade	IP20/IP62/IP65/IP67/IP68

Lumens

Color Temperature		
● Red	120lm/m	37lm/ft
● Green	330lm/m	101lm/ft
● Blue	60lm/m	18lm/ft
○ White		
● 2400K	340lm/m	104lm/ft
● 6000K	430lm/m	131lm/ft

Note:'x' (CCT) = "27"(2700K) / "30"(3000K) / "40"(4000K) / "50"(5000K) / "60"(6000K), Please contact us for more information.
* Please contact our sales for the latest details and certifications

Dimension



DIGITAL COLORFUL

SPI Series

DMX Series

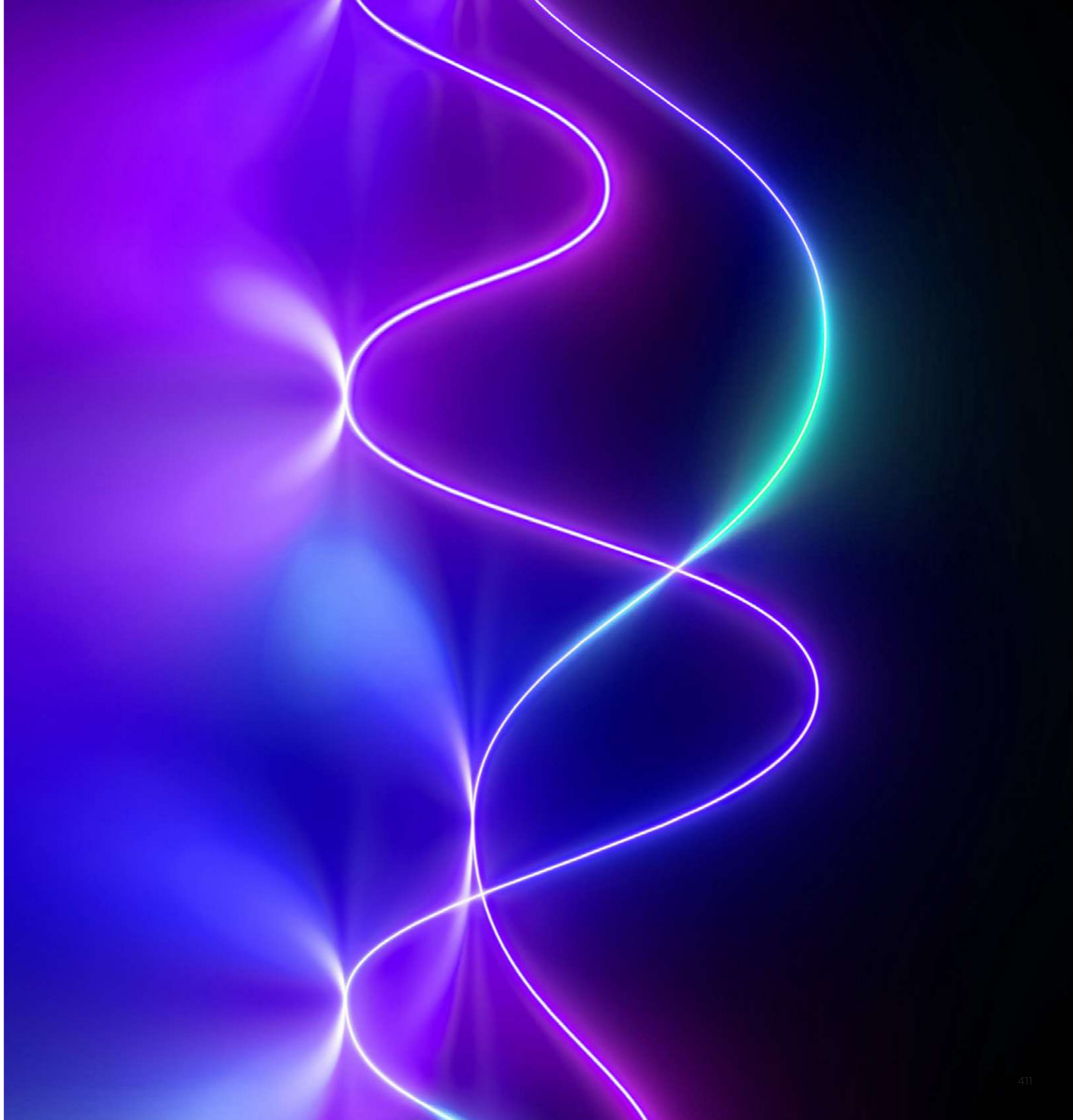

SPI Series

Built-in dot control IC, high consistency and reliability.
 RGBW 4 in 1 diode , present with variety color.
 The matched controller can realize the following effects:single color,
 gradient color change , chasing , animation and scene display.

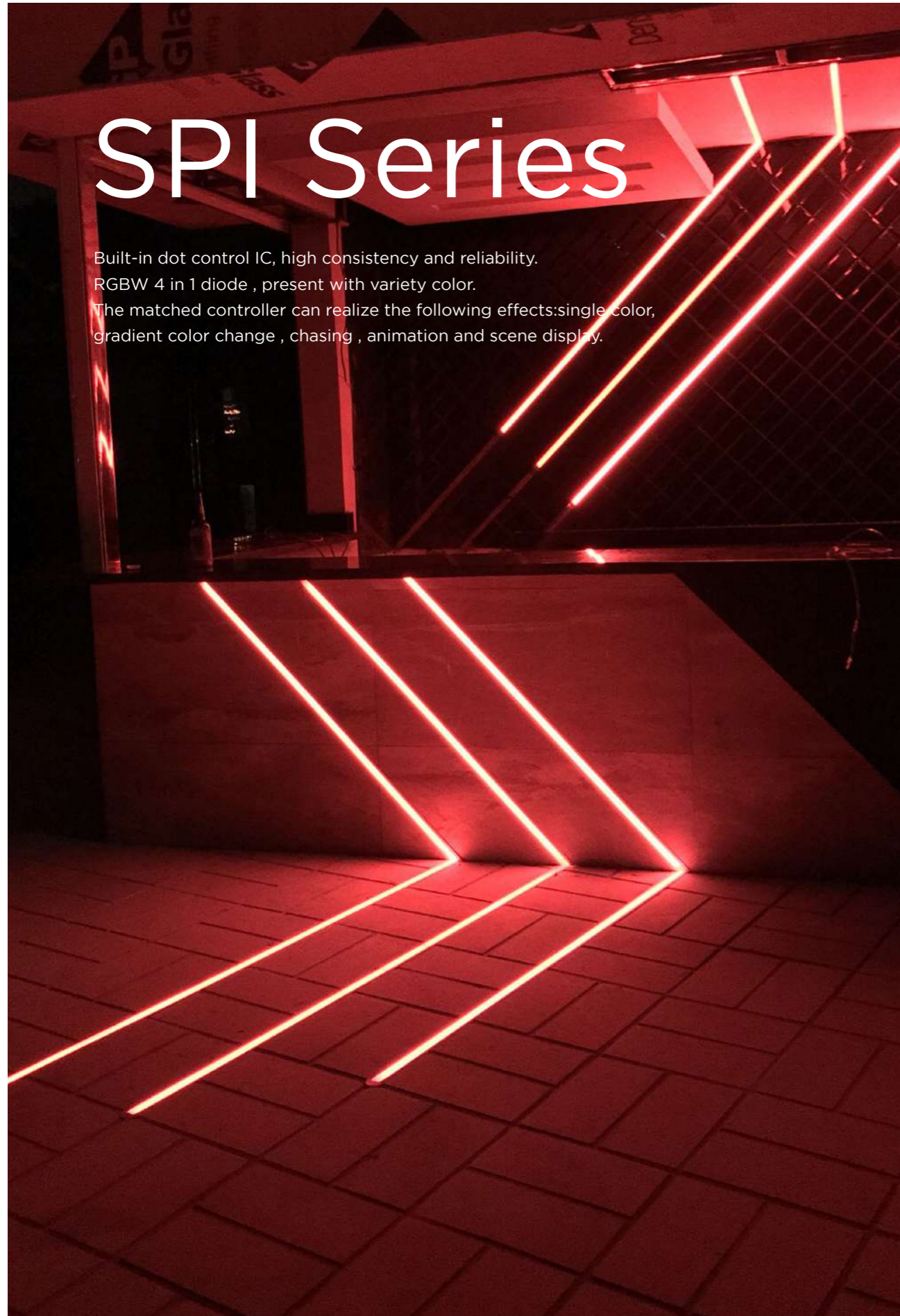

SPI Series / RGBW / 5050SMD / 5V 60LEDS/M 12W

Product NO. FE12D-P0-G1 50A1RGB9x 5VS60S1 W10L05



IP Grade

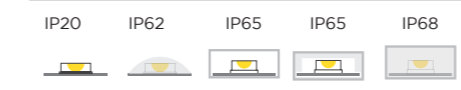

Technical Details

Power	12W/M 3.66W/ft
Voltage	DC5V
CRI	90
Led Qty	60LEDS/M 18LEDS/ft
Length/Reel	5M 16.41ft
Cutting Length	16.7mm 0.65"
IP Grade	IP20/IP62/IP65/IP68

Note:'x' (CCT) =*27*(2700K) / *30*(3000K) / *40*(4000K) / *50*(5000K) / *60*(6000K), Please contact us for more information.
 * Please contact our sales for the latest details and certifications

Lumens

Color Temperature		
● Red	615-625nm /120lm/m	36lm/ft
● Green	520-530nm /300lm/m	91lm/ft
● Blue	460-470nm /70lm/m	21lm/ft
○ White		
● 2700K	300lm/m	91lm/ft
● 3000K	310lm/m	95lm/ft
● 4000K	320lm/m	98lm/ft
● 5000K	340lm/m	104lm/ft
● 6000K	360lm/m	110lm/ft

Dimension



SPI Series / RGB / 5050SMD / 5V

60LEDS/M 14W

Product NO. FE14D-PO-G1 50B1RGB 5VS60S1 W10L05



IP Grade



Technical Details

Power	14W/M 4.27W/ft							
Voltage	DC5V							
CRI	-							
Led Qty	60LEDS/M 18LEDS/ft							
Color Temperature	● R		● G				● B	
Lumens	615-625nm 120lm/m 36lm/ft		520-530nm 300lm/m 91lm/ft				460-470nm 70lm 21lm/ft	
Length/Reel	5M 16.41ft							
Cutting Length	16.7mm 0.65"							
IP Grade	IP20/IP62/IP65/IP68							

Note: 'x' (CCT) = "27"(2700K) / "30"(3000K) / "40"(4000K) / "50"(5000K) / "60"(6000K), Please contact us for more information.

* Please contact our sales for the latest details and certifications

Dimension

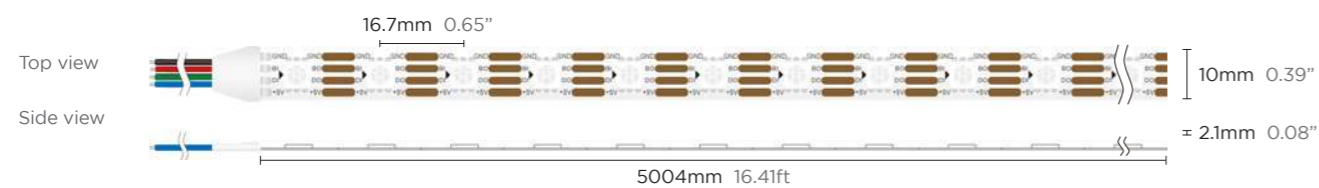

SPI Series / RGB / 5050SMD / 12V

60LEDS/M 14W

Product NO. FE14D-PO-G1 50AWRGB 12VS60S W10L05



IP Grade

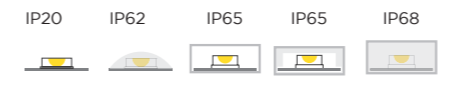

Technical Details

Power	14.4W/M 4.39W/ft							
Voltage	DC12V							
CRI	-							
Led Qty	60LEDS/M 18LEDS/ft							
Color Temperature	● R		● G				● B	
Lumens	615-625nm 105lm/m 32lm/ft		520-530nm 255lm/m 78lm/ft				460-470nm 60lm/m 18lm/ft	
Length/Reel	5M 16.41ft							
Cutting Length	50mm 1.96"							
IP Grade	IP20/IP62/IP65/IP68							

Note: 'x' (CCT) = "27"(2700K) / "30"(3000K) / "40"(4000K) / "50"(5000K) / "60"(6000K), Please contact us for more information.

* Please contact our sales for the latest details and certifications

Dimension

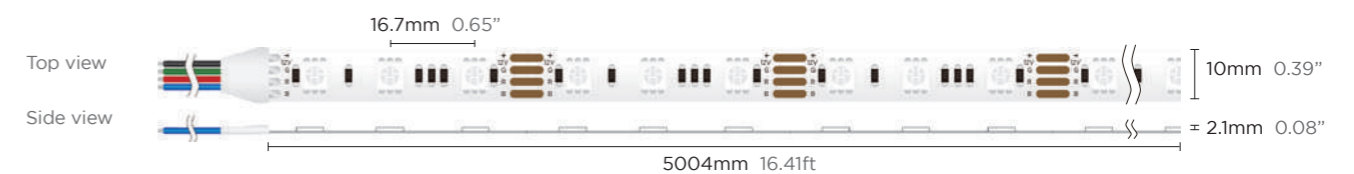

SPI Series / RGB / 5050SMD / 24V

60LEDS/M 14W

Product NO. FE14D-PO-G1 50AWRGB 24VS60S W10L05



IP Grade



Technical Details

Power	14.4W/M 4.39W/ft
Voltage	DC24V
CRI	-
Led Qty	60LEDS/M 18LEDS/ft
Color Temperature	● R ● G ● B
Lumens	615-625nm 110lm/m 34lm/ft 520-530nm 260lm/m 79lm/ft 460-470nm 60lm/m 18lm/ft
Length/Reel	5M 16.41ft
Cutting Length	100mm 3.93"
IP Grade	IP20/IP62/IP65/IP68

Note: 'x' (CCT) = "27"(2700K) / "30"(3000K) / "40"(4000K) / "50"(5000K) / "60"(6000K), Please contact us for more information.
 * Please contact our sales for the latest details and certifications

Dimension

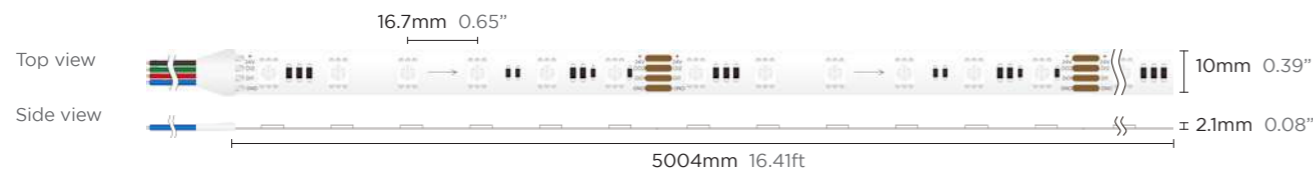

SPI Series / CCT / 2835SMD / 24V

120LEDS/M 14W

Product NO. FE14D-PO-G2 28HX8x 24VS120S W10L05



IP Grade



Technical Details

Power	14.4W/M 4.39W/ft
Voltage	DC24V
CRI	80
Led Qty	120LEDS/M 36LEDS/ft
Length/Reel	5M 16.41ft
Cutting Length	50mm 1.97"
IP Grade	IP20/IP62/IP65/IP68

Note: 'x' (CCT) = "27"(2700K) / "30"(3000K) / "40"(4000K) / "50"(5000K) / "60"(6000K), Please contact us for more information.
 * Please contact our sales for the latest details and certifications

Lumens

Color Temperature		
● 2700K	960lm/m	293lm/ft
● 3000K	1080lm/m	329lm/ft
● 4000K	1200lm/m	366lm/ft
● 6000K	1150lm/m	351lm/ft

Dimension

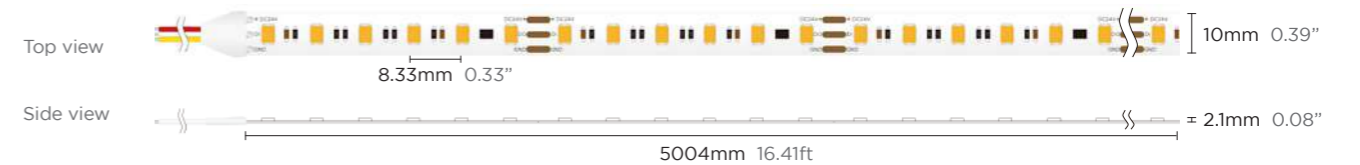

DMX Series

Colors jump & gradual changings can be realized by controller coding.
Varying color programs can be controlled by 10pixels per meter.
DMX512 control IC-SM18522PS.

DMX Series / CCT / 5050SMD / 24V

48LEDS/M 12W

Product NO. FE12D-P0-G2 50HZ9X 24VD48S W10L05



IP Grade

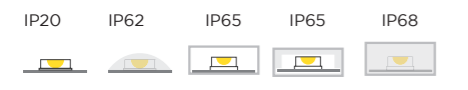

Technical Details

Power	12W/M 3.66W/ft
Voltage	DC24V
CRI	90
Led Qty	48LEDS/M 14LEDS/ft
Length/Reel	5M 16.41ft
Cutting Length	125mm 4.92"
IP Grade	IP20/IP62/IP65/IP68

Lumens

Color Temperature		
● 2700K	830lm/m	253lm/ft
● 3000K	840lm/m	256lm/ft
● 4000K	885lm/m	270lm/ft
● 5000K	885lm/m	270lm/ft
● 6000K	885lm/m	270lm/ft

Note: 'x' (CCT) = "27"(2700K) / "30"(3000K) / "40"(4000K) / "50"(5000K) / "60"(6000K), Please contact us for more information.
* Please contact our sales for the latest details and certifications

Dimension

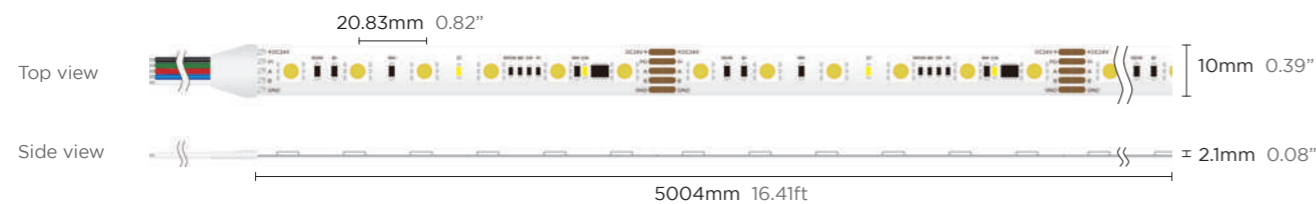

DMX Series / CCT / 2835SMD / 24V

112LEDS/M 14.4W

Product NO. FE14D-P0-G2 28HX8x 24VD112S14 W12L05



IP Grade



Technical Details

Power	14.4W/M 4.39W/ft
Voltage	DC24V
CRI	80
Led Qty	112LEDS/M 32LEDS/ft
Length/Reel	5M 16.41ft
Cutting Length	125mm 4.92"
IP Grade	IP20/IP62/IP65/IP68

Lumens

Color Temperature		
● 2700K	1220lm/m	372lm/ft
● 3000K	1300lm/m	396lm/ft
● 4000K	1370lm/m	418lm/ft
● 5000K	1350lm/m	412lm/ft
● 6000K	1350lm/m	412lm/ft

Note: 'x' (CCT) = "27"(2700K) / "30"(3000K) / "40"(4000K) / "50"(5000K) / "60"(6000K), Please contact us for more information.
* Please contact our sales for the latest details and certifications

Dimension

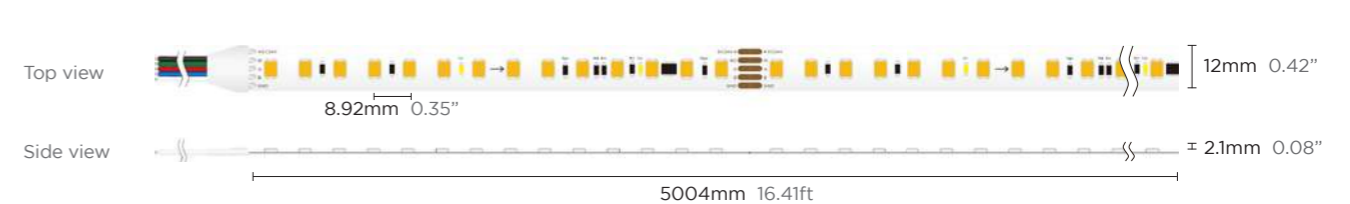



DMX Series / RGB / 5050SMD / 24V

48LEDS/M 12W

Product NO. FE12D-P0-G2 50ZRGB 24VD48S W10L05



IP Grade



Technical Details

Power	12W/M 3.66W/ft		
Voltage	DC24V		
CRI	-		
Led Qty	48LEDS/M 14LEDS/ft		
Color Temperature	● R	● G	● B
Lumens	102lm/m 31lm/ft	280lm/m 85lm/ft	57lm/m 17lm/ft
Length/Reel	5M 16.41ft		
Cutting Length	125mm 4.92"		
IP Grade	IP20/IP62/IP65/IP68		

Note: 'x' (CCT) = *27*(2700K) / *30*(3000K) / *40*(4000K) / *50*(5000K) / *60*(6000K), Please contact us for more information.
 * Please contact our sales for the latest details and certifications

Dimension



DMX Series / CCT / 5050SMD / 24V

56LEDS/M 12W

Product NO. FE12D-P0-G2 50HZ9X 24VD56S7 W10L05



IP Grade



Technical Details

Power	12W/M 3.66W/ft
Voltage	DC24V
CRI	90
Led Qty	56LEDs/M 17LEDs/ft
Length/Reel	5M 16.41ft
Cutting Length	125mm 4.92"
IP Grade	IP20/IP62/IP65/IP68

Lumens

Color Temperature		
● 2700K	960lm/m	293lm/ft
● 3000K	995lm/m	303lm/ft
● 4000K	1025lm/m	313lm/ft
● 5000K	1025lm/m	313lm/ft
● 6000K	1025lm/m	313lm/ft

Note: 'x' (CCT) = *27*(2700K) / *30*(3000K) / *40*(4000K) / *50*(5000K) / *60*(6000K), Please contact us for more information.
* Please contact our sales for the latest details and certifications

Dimension

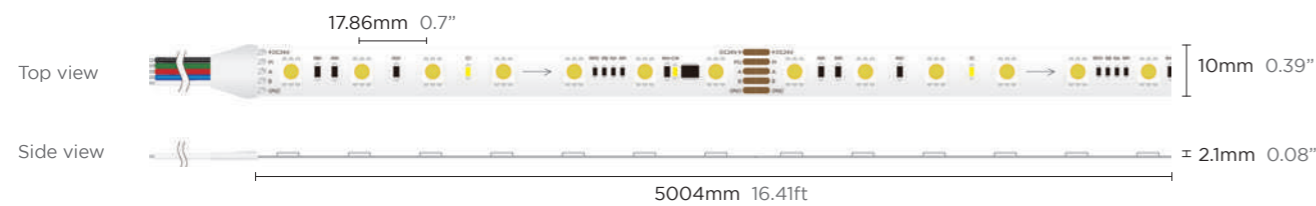

DMX Series / RGB&RGBW / 5050SMD / 24V

56LEDS/M 12W / 56LEDS/M 14W



IP Grade

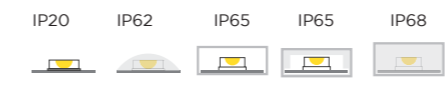

Technical Details 12W DMX RGB

Product NO.	FE12D-P0-G2 50ZRGB 24VD56S7 W10L05
Power	12W/M 3.65W/ft
Voltage	DC24V
CRI	-
Led Qty	56LEDs/M 17LEDs/ft
Length/Reel	5M 16.41ft
Cutting Length	125mm 4.92"
IP Grade	IP20/IP62/IP65/IP68
Color Temperature	● R ● G ● B
Lumens	122lm/m 37lm/ft 331lm/m 101lm/ft 68lm/m 21lm/ft

14W DMX RGBW

Product NO.	FE14D-P0-G2 50ZRGB8x 24VD56S7 W12L05
Power	14W/M 4.27W/ft
Voltage	DC24V
CRI	80
Led Qty	56LEDs/M 17LEDs/ft
Length/Reel	5M 16.41ft
Cutting Length	125mm 4.92"
IP Grade	IP20/IP62/IP65/IP68
Color Temperature	● R ● G ● B ● 3000K
Lumens	102lm/m 31lm/ft 300lm/m 92lm/ft 72lm/m 22lm/ft 308lm/m 94lm/ft

Note: 'x' (CCT) = *27*(2700K) / *30*(3000K) / *40*(4000K) / *50*(5000K) / *60*(6000K), Please contact us for more information.
* Please contact our sales for the latest details and certifications

Dimension

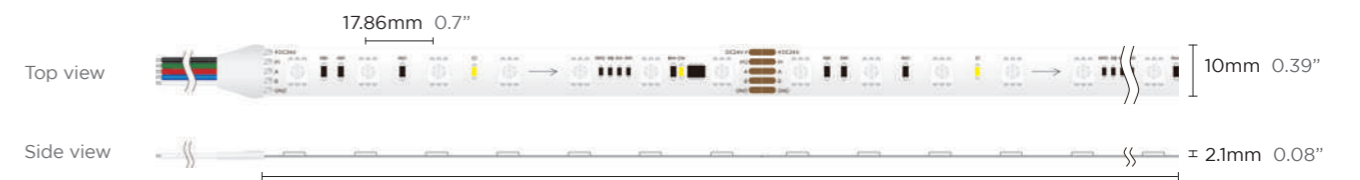

DMX Series / CCT / 5050SMD / 24V

60LEDS/M 14W

Product NO. FE14D-PO-G2 50HZ9X 24VD60S W10L05



IP Grade



Technical Details

Power	14W/M 4.26W/ft
Voltage	DC24V
CRI	90
Led Qty	60LEDS/M 18LEDS/ft
Length/Reel	5M 16.41ft
Cutting Length	100mm 3.93"
IP Grade	IP20/IP62/IP65/IP68

Lumens

Color Temperature	lm/m	lm/ft
● 2700K	965lm/m	294lm/ft
● 3000K	980lm/m	299lm/ft
● 4000K	1035lm/m	316lm/ft
● 5000K	1035lm/m	316lm/ft
● 6000K	1035lm/m	316lm/ft

Note: 'x' (CCT) = "27"(2700K) / "30"(3000K) / "40"(4000K) / "50"(5000K) / "60"(6000K), Please contact us for more information.
 * Please contact our sales for the latest details and certifications

Dimension

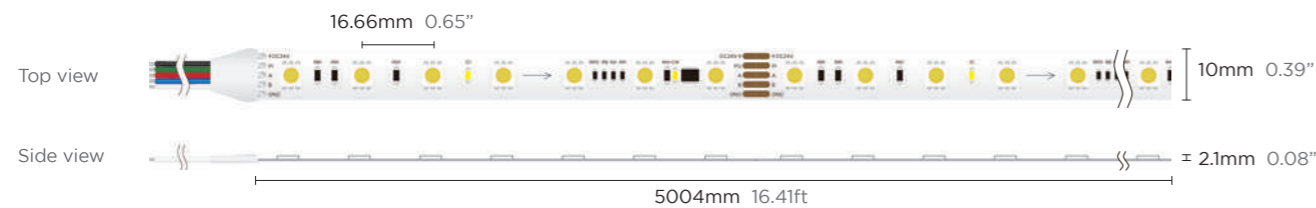

DMX Series / RGB / 5050SMD / 24V

60LEDS/M 14W

Product NO. FE14D-PO-G2 50ZRGB 24VD60S W10L05



IP Grade



Technical Details

Power	14W/M 4.26W/ft					
Voltage	DC24V					
CRI	-					
Led Qty	60LEDS/M 18LEDS/ft					
Color Temperature	● R	● G	● B			
Lumens	125lm/m 38lm/ft	355lm/m 108lm/ft	75lm/m 23lm/ft			
Length/Reel	5M 16.41ft					
Cutting Length	100mm 3.93"					
IP Grade	IP20/IP62/IP65/IP68					

Note: 'x' (CCT) = "27"(2700K) / "30"(3000K) / "40"(4000K) / "50"(5000K) / "60"(6000K), Please contact us for more information.
 * Please contact our sales for the latest details and certifications

Dimension

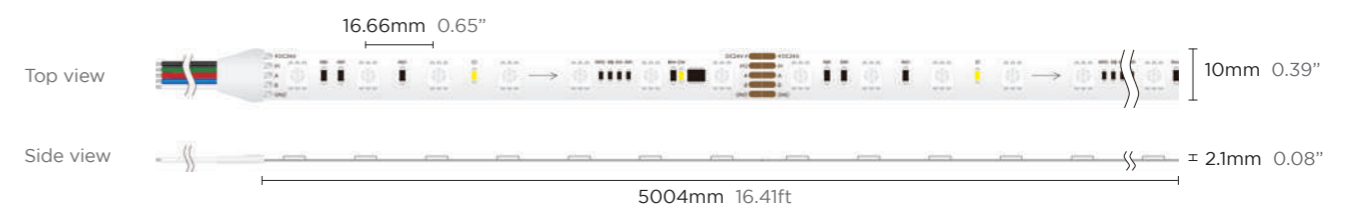

DMX Series / RGBW / 5050SMD / 24V

Product NO. FE14D-PO-G2 50ZRGB8x 24VD60S W12L05



IP Grade



Technical Details 12W DMX RGBW

Product NO.	FE14D-PO-G2 50ZRGB8x 24VD60S W12L05			
Power	14.4W/M 4.27W/ft			
Voltage	DC24V			
CRI	80			
Led Qty	60LEDs/M 18LEDs/ft			
Length/Reel	5M 16.41ft			
Cutting Length	100mm 3.97"			
IP Grade	IP20/IP62/IP65/IP68			
Color Temperature	●R	●G	●B	●4000K
Lumens	90lm/m 27lm/ft	280lm/m 85lm/ft	70lm/m 21lm/ft	305lm/m 93lm/ft

Note: 'x' (CCT) = "27"(2700K) / "30"(3000K) / "40"(4000K) / "50"(5000K) / "60"(6000K), Please contact us for more information.

Dimension



DMX Series / CCT / 5050SMD / 24V

112LEDS/M 14W

Product NO. FE14D-PO-G2 28HX8x 24VD112S14 W12L05



IP Grade

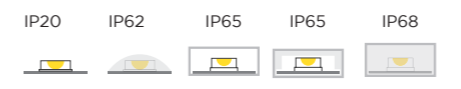

Technical Details

Power	14.4W/M 4.27W/ft
Voltage	DC24V
CRI	80
Led Qty	112LEDs/M 34LEDs/ft
Length/Reel	5M 16.41ft
Cutting Length	125mm 4.92"
IP Grade	IP20/IP62/IP65/IP68

Note: 'x' (CCT) = "27"(2700K) / "30"(3000K) / "40"(4000K) / "50"(5000K) / "60"(6000K), Please contact us for more information.
* Please contact our sales for the latest details and certifications

Lumens

Color Temperature		
●2700K	1220lm/m	372lm/ft
●3000K	1300lm/m	396lm/ft
●4000K	1370lm/m	418lm/ft
●5000K	1350lm/m	411lm/ft
●6000K	1350lm/m	411lm/ft

Dimension



SPECIAL SERIES

Soft Lighting

4020 Side Emitting Series

160° Monolithic Integrated Lens

12V / 24V Switchable Series

Haute Color Series

Fresh Food / Jewelry Lighting

S Type Series



Soft lighting 12x6mm

WHITE / RGB



Diffuse design, lights softer.
Bendable at horizontal direction.
IP67 protection.
Robust housing with high quality silicon, UV proof for true outdoor application.



Accessories



2700K 3000K 4000K 6000K



Technical Details 1206 White 14W

1206 RGB 14W

Product NO.	FEN14W-P7-G1 28HX8x 24V60S 1206L05	FEN14C-P7-G1 50ZRGB 24V60S 1206L05
Voltage	DC24V	DC24V
Power	14W/M 4.26W/ft	14W/M 4.26W/ft
CRI	90	90
Led Qty	60LEDs/M 18LEDs/ft	60LEDs/M 18LEDs/ft
Cutting Length	100mm 3.93"	100mm 3.93"
IP Grade	IP67	IP67
Length/Reel	5050mm 16.56ft	5050mm 16.56ft
Color temperature	● 2700K ● 3000K ● 4000K ○ 6000K	● R ● G ● B
Lumens	1204lm/m 367lm/ft 1274lm/m 388lm/ft 1302lm/m 397lm/ft 1302lm/m 397lm/ft	126lm/m 38m/ft 350lm/m 107lm/ft 71lm/m 22lm/ft

Note: 'x' (CCT) = "27"(2700K) / "30"(3000K) / "40"(4000K) / "50"(5000K) / "60"(6000K), Please contact us for more information.

Dimension

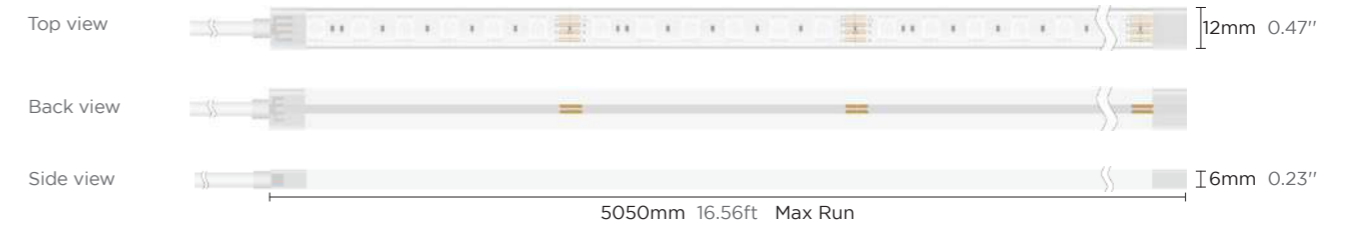

※ Please contact our sales for the latest details and certifications

4020 Side Emitting Series

Suitable for ultra-thin light box, counters, crevices, etc.
 High light efficiency, up to 120LM/W.
 High color consistency, SDCM<5.



SPECIAL SERIES · 4020 SIDE EMITTING SERIES



Product NO. FE05WS-P0-G1 40X9x 24V70S7 W08L05

Technical Details

Power	4.8W/M 1.46W/ft
Voltage	DC24V
CRI	90
Led Qty	70LEDs/M 21LEDs/ft
Length/Reel	5M 16.41ft
IP Grade	IP20

Lumens

Color Temperature		
2700K	530lm/m	162lm/ft
3000K	550lm/m	168lm/ft
4000K	580lm/m	177lm/ft
5000K	580lm/m	177lm/ft
6000K	550lm/m	168lm/ft

Product NO. FE10WS-P0-G1 40X9x 24V140S7 W08L05

Technical Details

Power	9.6W/M 2.93W/ft
Voltage	DC24V
CRI	90
Led Qty	140LEDs/M 42LEDs/ft
Length/Reel	5M 16.41ft
IP Grade	IP20

Lumens

Color Temperature		
2700K	1060lm/m	323lm/ft
3000K	1100lm/m	335lm/ft
4000K	1160lm/m	354lm/ft
5000K	1160lm/m	354lm/ft
6000K	1100lm/m	335lm/ft

Note: 'x' (CCT) = "27"(2700K) / "30"(3000K) / "40"(4000K) / "50"(5000K) / "60"(6000K), Please contact us for more information.

* Please contact our sales for the latest details and certifications

SPECIAL SERIES · 4020 SIDE EMITTING SERIES

Dimension

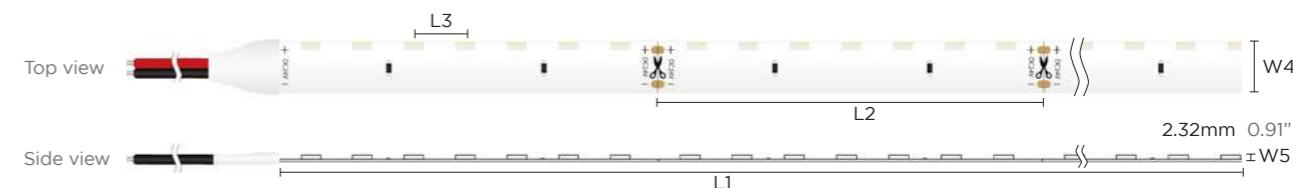

	L1	L2	L3	W4
FE06W-P0-G1 50X8X 24V30S7 W10L05	5m 16.41ft	100mm 3.93"	14.3mm 0.56"	8mm 0.31"
FE07W-P0-G1 50X9X 24V30S7 W10L05	5m 16.41ft	50mm 1.96"	7.1mm 0.27"	8mm 0.31"

160° Monolithic Integrated Lens

With lens large angle 160°, replace traditional diffuse reflectors.
2700-6000K Multi-color temperature optional.



SPECIAL SERIES · 160° MONOLITHIC INTEGRATED LENS

SPECIAL SERIES · 160° MONOLITHIC INTEGRATED LENS

Technical Details

Product NO. FE10W-PO-G1 60AT8x 24V24S4 W10L05 160°

Power	9.6W/M 2.93W/ft
Voltage	DC24V
CRI	80
Led Qty	24LEDs/M 7LEDs/ft
Length/Reel	5M 16.41ft
IP Grade	IP20

Lumens

Color Temperature		
2700K	1200lm/m	366lm/ft
3000K	1250lm/m	381lm/ft
4000K	1300lm/m	396lm/ft
5000K	1300lm/m	396lm/ft
6000K	1250lm/m	381lm/ft

Product NO. FE14W-PO-G1 60AT8x 24V48S4 W10L05 160°

Power	14.4W/M 4.39W/ft
Voltage	DC24V
CRI	80
Led Qty	48LEDs/M 14LEDs/ft
Length/Reel	5M 16.41ft
IP Grade	IP20

Lumens

Color Temperature		
2700K	1850lm/m	564lm/ft
3000K	1950lm/m	595lm/ft
4000K	2050lm/m	625lm/ft
5000K	2050lm/m	625lm/ft
6000K	1950lm/m	595lm/ft

Product NO. FE19W-PO-G1 60AT8x 24V64S4 W10L05 160°

Power	19.2W/M 5.85W/ft
Voltage	DC24V
CRI	80
Led Qty	64LEDs/M 19LEDs/ft
Length/Reel	5M 16.41ft
IP Grade	IP20

Lumens

Color Temperature		
2700K	2500lm/m	762lm/ft
3000K	2600lm/m	793lm/ft
4000K	2700lm/m	823lm/ft
5000K	2700lm/m	823lm/ft
6000K	2600lm/m	793lm/ft

Note: 'x' (CCT) = "27"(2700K) / "30"(3000K) / "40"(4000K) / "50"(5000K) / "60"(6000K), Please contact us for more information.

* Please contact our sales for the latest details and certifications

Dimension

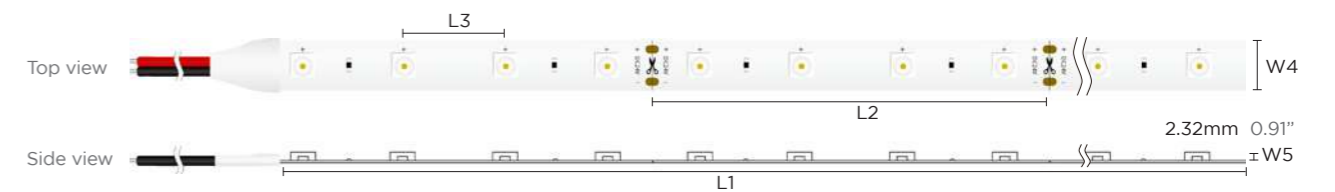

	L1	L2	L3	W4
FE10W-PO-G1 60AT8x 24V24S4 W10L05 160°	5m 16.41ft	166.67mm 6.56"	41.66mm 1.64"	10mm 0.39"
FE14W-PO-G1 60AT8x 24V48S4 W10L05 160°	5m 16.41ft	83.3mm 3.27"	20.83mm 0.82"	10mm 0.39"
FE19W-PO-G1 60AT8x 24V64S4 W10L05 160°	5m 16.41ft	62.5mm 2.46"	15.62mm 0.61"	10mm 0.39"

12V/24V Switchable Series

High CRI, CRI>90.
 High efficiency.
 High color consistency, SDCM<5, optional for SDCM<3.
 12V and 24V power supply can be selected for different wiring modes.



SPECIAL SERIES · 12V/24V SWITCHABLE SERIES

SPECIAL SERIES · 12V/24V SWITCHABLE SERIES

Technical Details

Product NO. FH05W-PO-G1 28LZ9x 12V24V60S W08L05

Power	4.8W/M 1.46W/ft
Voltage	DC12V/DC24V
CRI	90
Led Qty	60LEDs/M 18LEDs/ft
Length/Reel	5M 16.41ft
IP Grade	IP20

Lumens

Color Temperature		
● 2700K	380lm/m	116lm/ft
● 3000K	400lm/m	122lm/ft
● 4000K	440lm/m	134lm/ft
● 5000K	440lm/m	134lm/ft
● 6000K	430lm/m	131lm/ft

Product NO. FH10W-PO-G1 28LZ9x 12V24V120S W08L05

Power	9.6W/M 2.93W/ft
Voltage	DC12V/DC24V
CRI	90
Led Qty	120LEDs/M 36LEDs/ft
Length/Reel	5M 16.41ft
IP Grade	IP20

Lumens

Color Temperature		
● 2700K	770lm/m	235lm/ft
● 3000K	800lm/m	244lm/ft
● 4000K	900lm/m	274lm/ft
● 5000K	900lm/m	274lm/ft
● 6000K	880lm/m	268lm/ft

Note: 'x' (CCT) = "27"(2700K) / "30"(3000K) / "40"(4000K) / "50"(5000K) / "60"(6000K), Please contact us for more information.

※ Please contact our sales for the latest details and certifications

Dimension

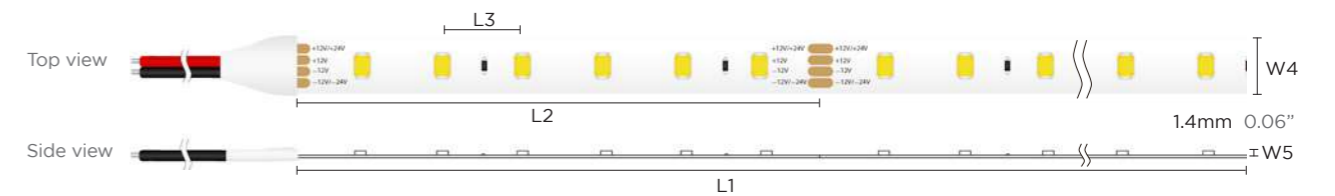

	L1	L2	L3	W4
FH05W-PO-G1 28LZ9x 12V/24V60S W08L05	5m 16.41ft	100mm 3.93"	16.7mm 0.65"	8mm 0.31"
FH10W-PO-G1 28LZ9x 12V/24V120S W08L05	5m 16.41ft	50mm 1.96"	8.3mm 0.32"	8mm 0.31"

Haute Color Series



Ice Blue



Pink



Tomato



Violet



Rose red



Golden Light

Ice Blue

FH10M-PO-G1 28LZIB 24V120S W08L05

Power	9.6W/M 2.93W/ft
Voltage	DC24V
Led Qty	120LEDs/M 36LEDs/ft
Lumens	550lm/m 168lm/ft
Prpc WL	Ld=488.8nm
Peak WL	Lp=493nm

Pink

FH10M-PO-G1 28LZPI 24V120S W08L05

Power	9.6W/M 2.93W/ft
Voltage	DC24V
Led Qty	120LEDs/M 36LEDs/ft
Lumens	650lm 198lm/ft
Prpc WL	Ld=501.2nm
Peak WL	Lp=451nm

Tomato

FH10M-PO-G1 28LZTO 24V120S W08L05

Power	9.6W/M 2.93W/ft
Voltage	DC24V
Led Qty	120LEDs/M 36LEDs/ft
Lumens	645lm 197lm/ft
Prpc WL	Ld=607.9nm
Peak WL	Lp=613nm

Violet

FH10M-PO-G1 28LZVI 24V120S W08L05

Power	9.6W/M 2.93W/ft
Voltage	DC24V
Led Qty	120LEDs/M 36LEDs/ft
Lumens	205lm 63lm/ft
Prpc WL	Ld=439.8nm
Peak WL	Lp=451nm

Rose red

FH10M-PO-G1 28LZRO 24V120S W08L05

Power	9.6W/M 2.93W/ft
Voltage	DC24V
Led Qty	120LEDs/M 36LEDs/ft
Lumens	360lm 110lm/ft
Prpc WL	Ld=552.9nm
Peak WL	Lp=451nm

Golden Light

FH10M-PO-G1 28HZGD 24V120S W10L05

Power	9.6W/M 2.93W/ft
Voltage	DC24V
Led Qty	120LEDs/M 36LEDs/ft
Lumens	1030lm 314lm/ft
Prpc WL	Ld=590nm
Peak WL	Lp=594nm

Dimension



L1	L2	L3	W4	IP
5m 16.41ft	50mm 1.96"	8.3mm 0.32"	8mm 0.31"	IP20

Fresh food / jewelry lighting



SPECIAL SERIES · FRESH FOOD / JEWELRY LIGHTING



Cake/Cheese FH14M-P0-G1 28HZCA 24V192S8 W10L05	
Power	14W/M 4.26W/ft
Voltage	DC24V
Led Qty	192LEDs/M 59LEDs/ft
Lumens	1610lm/m 491lm/ft
Prpc WL	Ld=588nm
Peak WL	Lp=627nm



Seafood FH14M-P0-G1 28HZSE 24V192S8 W10L05	
Power	14W/M 4.26W/ft
Voltage	DC24V
Led Qty	192LEDs/M 59LEDs/ft
Lumens	1930lm/m 588lm/ft
Prpc WL	Ld=580nm
Peak WL	Lp=456nm



Fruit FH14M-P0-G1 28HZFR 24V192S8 W10L05	
Power	14W/M 4.26W/ft
Voltage	DC24V
Led Qty	192LEDs/M 59LEDs/ft
Lumens	1680lm/m 512lm/ft
Prpc WL	Ld=584nm
Peak WL	Lp=623nm



Pickled ham FH14M-P0-G1 28HZME 24V192S8 W10L05	
Power	14W/M 4.26W/ft
Voltage	DC24V
Led Qty	192LEDs/M 59LEDs/ft
Lumens	2100lm/m 640lm/ft
Prpc WL	Ld=494nm
Peak WL	Lp=452nm



Fresh Meat FH14M-P0-G1 28HZFM 24V192S8 W10L05	
Power	14W/M 4.26W/ft
Voltage	DC24V
Led Qty	192LEDs/M 59LEDs/ft
Lumens	1330lm/m 405lm/ft
Prpc WL	Ld=603nm
Peak WL	Lp=630nm



Bread FH14M-P0-G1 28HZBR 24V192S8 W10L05	
Power	14W/M 4.26W/ft
Voltage	DC24V
Led Qty	192LEDs/M 59LEDs/ft
Lumens	1620lm/m 494lm/ft
Prpc WL	Ld=585nm
Peak WL	Lp=620nm



Jadeite lighting FH14M-P0-G1 28HZJA 24V192S8 W10L05	
Power	14W/M 4.26W/ft
Voltage	DC24V
Led Qty	192LEDs/M 59LEDs/ft
Lumens	1540lm/m 470lm/ft
Prpc WL	Ld=581nm
Peak WL	Lp=457nm



Cosmetic lighting FH14M-P0-G1 28HZCO 24V192S8 W10L05	
Power	14W/M 4.26W/ft
Voltage	DC24V
Led Qty	192LEDs/M 59LEDs/ft
Lumens	1840lm/m 561lm/ft
Prpc WL	Ld=579nm
Peak WL	Lp=456nm



Golden lighting FH14M-P0-G1 28HZGD 24V192S8 W10L05	
Power	14W/M 4.26W/ft
Voltage	DC24V
Led Qty	192LEDs/M 59LEDs/ft
Lumens	1650lm/m 503lm/ft
Prpc WL	Ld=590nm
Peak WL	Lp=634nm



Diamond lighting FH14M-P0-G1 28HZDI 24V192S8 W10L05	
Power	14W/M 4.26W/ft
Voltage	DC24V
Led Qty	192LEDs/M 59LEDs/ft
Lumens	1680lm/m 512lm/ft
Prpc WL	Ld=480nm
Peak WL	Lp=455nm



Crystal lighting FH14M-P0-G1 28HZCR 24V192S8 W10L05	
Power	14W/M 4.26W/ft
Voltage	DC24V
Led Qty	192LEDs/M 59LEDs/ft
Lumens	1980lm/m 470lm/ft
Prpc WL	Ld=579nm
Peak WL	Lp=456nm

SPECIAL SERIES · FRESH FOOD / JEWELRY LIGHTING

Dimension

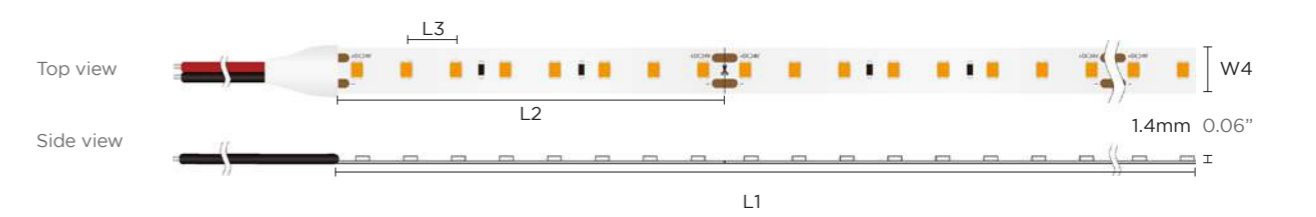

L1	L2	L3	W4	IP
5m 16.41ft	41.7mm 1.64"	5.21mm 0.2"	10mm 0.39"	IP20

S type Series / 12V

White



Designed for signs, sculptured lettering and back lit lighting.
Easy to install around tight corners.
Continuous length up to 5m.



White/ 60LEDs

Product NO. FHS05W-P0-G1 28LZ9xx 12V60S W08L05

Power	4.8W/M 1.46W/ft
Voltage	DC12V
CRI	90
Led Qty	60LEDs/M 18LEDs/ft
Length/Reel	5m 16.41ft
Cutting Length	50mm 1.97"
IP Grade	IP20
Lumens	
● 2700K	435lm/m 133lm/ft
● 3000K	455lm/m 139lm/ft
● 4000K	475lm/m 145lm/ft
● 5000K	475lm/m 145lm/ft
● 6000K	475lm/m 145lm/ft

White/ 120LEDs

Product NO. FHS05W-P0-G1 28LZ9xx 12V120S W06L05

Power	4.8W/M 1.46W/ft
Voltage	DC12V
CRI	90
Led Qty	120LEDs/M 36LEDs/ft
Length/Reel	5m 16.41ft
Cutting Length	25mm 0.98"
IP Grade	IP20
Lumens	
● 2700K	435lm/m 133lm/ft
● 3000K	455lm/m 139lm/ft
● 4000K	480lm/m 146lm/ft
● 5000K	480lm/m 146lm/ft
● 6000K	480lm/m 146lm/ft

Note:'x' (CCT) = "27"(2700K) / "30"(3000K) / "40"(4000K) / "50"(5000K) / "60"(6000K), Please contact us for more information.

* Please contact our sales for the latest details and certifications

Dimension

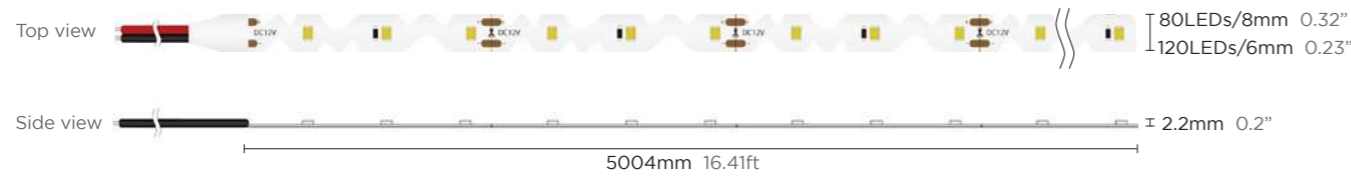

S type Series / 24V

White



Designed for signs, sculptured lettering and back lit lighting.
Easy to install around tight corners.
Continuous length up to 5m.



White/ 60LEDs

Product NO. FHS10W-P0-G1 28HZ9x 24V60S W08L05

Power	9.6W/M 2.92W/ft
Voltage	DC24V
CRI	90
Led Qty	60LEDs/M 18LEDs/ft
Length/Reel	5m 16.41ft
Cutting Length	100mm 3.93"
IP Grade	IP20
Lumens	
● 2700K	864lm/m 263lm/ft
● 3000K	900lm/m 274lm/ft
● 4000K	930lm/m 284lm/ft
● 5000K	930lm/m 284lm/ft
● 6000K	930lm/m 284lm/ft

White/ 120LEDs

Product NO. FHS05W-P0-G1 28LZ9x 24V120S W06L05

Power	4.8W/M 1.46W/ft
Voltage	DC24V
CRI	90
Led Qty	120LEDs/M 36LEDs/ft
Length/Reel	5m 16.41ft
Cutting Length	50mm 1.97"
IP Grade	IP20
Lumens	
● 2700K	430lm/m 131lm/ft
● 3000K	450lm/m 137lm/ft
● 4000K	470lm/m 143lm/ft
● 5000K	470lm/m 143lm/ft
● 6000K	470lm/m 143lm/ft

Note:'x' (CCT) = "27"(2700K) / "30"(3000K) / "40"(4000K) / "50"(5000K) / "60"(6000K), Please contact us for more information.

* Please contact our sales for the latest details and certifications

Dimension



SPECIAL SERIES · S TYPE SERIES

SPECIAL SERIES · S TYPE SERIES

S type Series / 24V

Designed for signs, sculptured lettering and back lit lighting.

Easy to install around tight corners.

Continuous length up to 5m.



RGB



48LEDs

Product NO. FHS10C-PO-G1 50ZRGB 24V48S W10L05

Power	9.6W/M 2.92W/ft
Voltage	DC24V
CRI	/(5050 SMD)
Led Qty	48LEDs/M 14LEDs/ft
Length/Reel	5m 16.41ft
Cutting Length	125mm 4.92"
IP Grade	IP20

Lumens

R	G	B
124lm/m 38lm/ft	345lm/m 105lm/ft	67lm/m 20lm/ft

RGBW



48LEDs

Product NO. FHS14C-PO-G1 50ZRGB8X 24V48S W12L05

Power	14.4W/M 4.39W/ft
Voltage	DC24V
CRI	80(5050 SMD)
Led Qty	48LEDs/M 14LEDs/ft
Length/Reel	5m 16.41ft
Cutting Length	125mm 4.92"
IP Grade	IP20

Lumens

R	G	B	4000K
128lm/m 39lm/ft	333lm/m 102lm/ft	87lm/m 27lm/ft	415lm/m 127lm/ft

Dimension

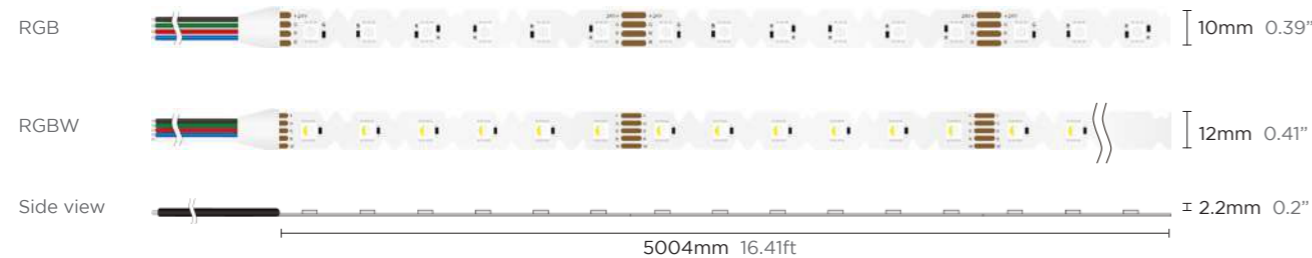

CONNECTORS

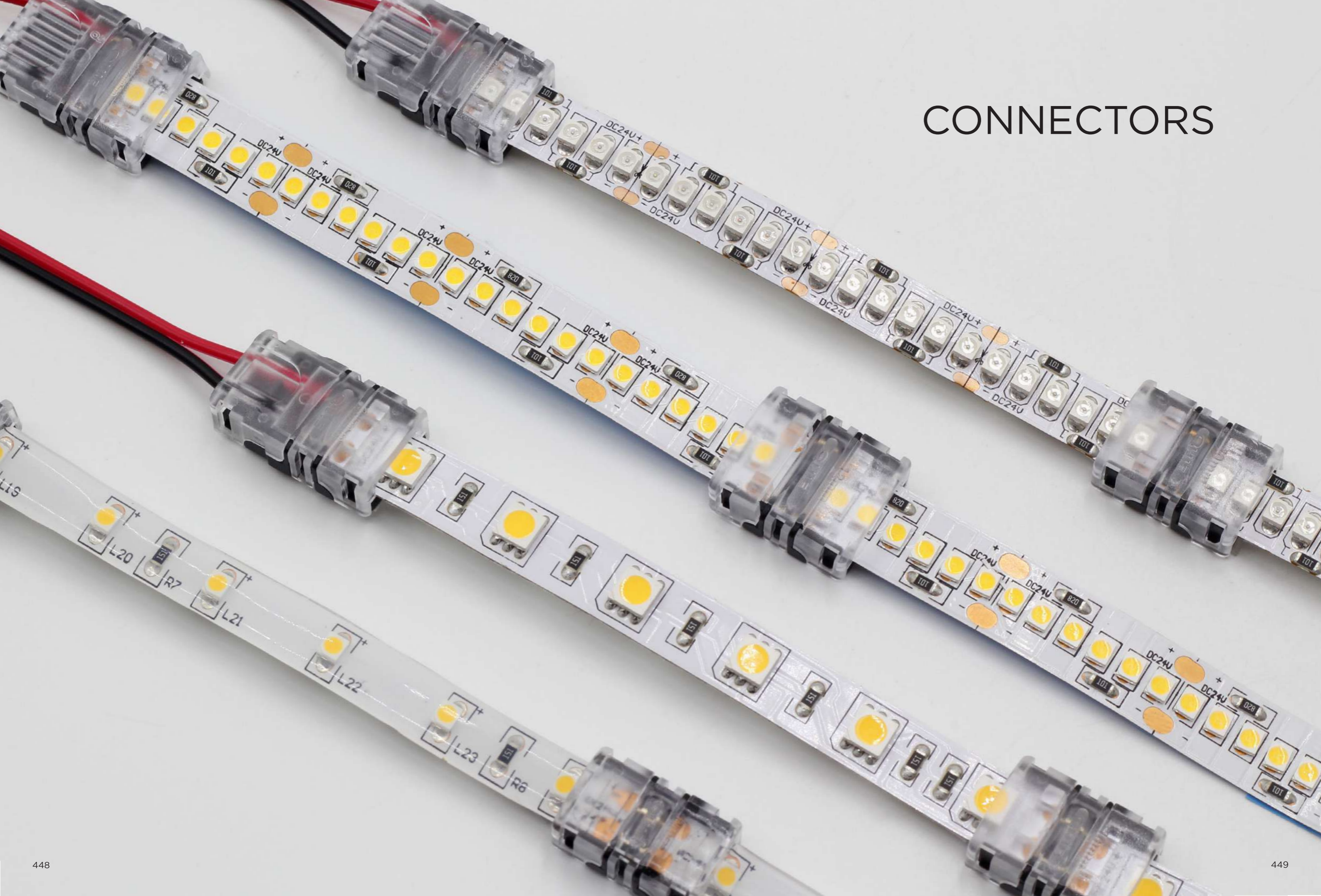

CONNECTORS

Single Color / IP20

Series	Product			PCB Width	LED QTY	Product NO.
	BB PCB to PCB	XB Cable to PCB	BXB PCB to Cable to PCB			
LD-SR Series Maximum voltage: 36V Maximum current: 3A				8mm 0.31"	60-180LEDs/M 18-55LEDs/ft	LD-SR-8BB-2Q LD-SR-8XB-2Q LD-SR-8BxB-2Q
				10mm 0.39"	30-180LEDs/M 9-55LEDs/ft	LD-SR-10BB-2Q LD-SR-10XB-2Q LD-SR-10BxB-2Q
LD-SE Series Maximum voltage: 36V Maximum current: 5A			/	8mm 0.31"	60-120LEDs/M 18-36LEDs/ft	LD-SE-N8XB-2 LD-SE-N8BB-2
				10mm 0.39"	60-160LEDs/M 18-36LEDs/ft	LD-SE-N10XB-2 LD-SE-N10BB-2
					64-240LEDs/M 19-73LEDs/ft	LD-SE-N10XB-2G LD-SE-N10BB-2G
LD-SL Series Maximum voltage: 36V Maximum current: 5A			/	8mm 0.31"	60-240LEDs/M 18-73LEDs/ft	LD-SL-8BB-2 LD-SL-8XB-2 LD-SL-8BxB-2
				10mm 0.39"	60-240LEDs/M 18-73LEDs/ft	LD-SL-10BB-2 LD-SL-10XB-2 LD-SL-10BxB-2





RGB / IP20

Series	Product			PCB Width	LED QTY	Product NO.
	BB PCB to PCB	XB Cable to PCB	BXB PCB to Cable to PCB			
LD-SR Series Maximum voltage: 36V Maximum current: 3A				10mm 0.39"	30-140LEDs/M 9-44LEDs/ft	LD-SR-10BB-4 LD-SR-10XB-4 LD-SR-10BxB-4
LD-SE Series Maximum voltage: 36V Maximum current: 5A			/	10mm 0.39"	30-144LEDs/M 9-44LEDs/ft	LD-SE-N10XB-4 LD-SE-N10BB-4
LD-SL Series Maximum voltage: 36V Maximum current: 6A			/	10mm 0.39"	30-144LEDs/M 9-44LEDs/ft	LD-SL-10BB-4 LD-SL-10XB-4

Tunable / IP20

Series	Product			PCB Width	LED QTY	Product NO.
	BB PCB to PCB	XB Cable to PCB	BXB PCB to Cable to PCB			
LD-SE Series Maximum voltage: 36V Maximum current: 5A			Not BXB	10mm 0.39"	60-120LEDs/M 18-36LEDs/ft	LD-SE-N10XB-3 LD-SE-N10BB-3
LD-SL Series Maximum voltage: 36V Maximum current: 6A			/	10mm 0.39"	60-120LEDs/M 18-36LEDs/ft	LD-SL-10BB-3 LD-SL-10XB-3

RGBW / IP20

Series	Product			PCB Width	LED QTY	Product NO.
	BB PCB to PCB	XB Cable to PCB	BXB PCB to Cable to PCB			
LD-SR Series Maximum voltage: 36V Maximum current: 3A				12mm 0.47"	-	LD-SR-12BB-5 LD-SR-12XB-5 LD-SR-12BxB-5
LD-SE Series Maximum voltage: 36V Maximum current: 5A			/	12mm 0.47"	-	LD-SE-N12XB-5 LD-SE-N12BB-5

Single Color / IP62

Series	Product			PCB Width	LED QTY	Product NO.
	BB PCB to PCB	XB Cable to PCB	BXB PCB to Cable to PCB			
LD-SE Series Maximum voltage: 36V Maximum current: 5A			/	8mm 0.31"	60-120LEDs/M 18-36LEDs/ft	LD-DJ-N8XB-2 LD-DJ-N8BB-2
				10mm 0.39"	60-160LEDs/M 18-48LEDs/ft	LD-DJ-N10XB-2 LD-DJ-N10BB-2
LD-DJ Series Maximum voltage: 36V Maximum current: 4A				8mm 0.31"	60-120LEDs/M 18-36LEDs/ft	LD-DJ-8BB-2 LD-DJ-8XB-2 LD-DJ-8BxB-2
				10mm 0.39"	60-128LEDs/M 18-39LEDs/ft	LD-DJ-10BB-2 LD-DJ-10XB-2 LD-DJ-10BxB-2

Tunable / IP62

Series	Product			PCB Width	LED QTY	Product NO.
	BB PCB to PCB	XB Cable to PCB	BXB PCB to Cable to PCB			
LD-SE Series Maximum voltage: 36V Maximum current: 5A			/	10mm 0.39"	60-120 LEDs/M 18-36LEDs/ft	LD-DJ-N10XB-3 LD-DJ-N10BB-3

RGB / IP62

Series	Product			PCB Width	LED QTY	Product NO.
	BB PCB to PCB	XB Cable to PCB	BXB PCB to Cable to PCB			
LD-SE Series Maximum voltage: 36V Maximum current: 5A			/	10mm 0.39"	30-144 LEDs/M 9-44LEDs/ft	LD-DJ-N10XB-4 LD-DJ-N10BB-4
LD-DJ Series Maximum voltage: 36V Maximum current: 4A				10mm 0.39"	30-144 LEDs/M 9-44LEDs/ft	LD-DJ-10BB-4 LD-DJ-10XB-4 LD-DJ-10BxB-4

RGBW / IP62

Series	Product			PCB Width	LED QTY	Product NO.
	BB PCB to PCB	XB Cable to PCB	BXB PCB to Cable to PCB			
LD-SE Series Maximum voltage: 36V Maximum current: 5A			/	12mm 0.39"	-	LD-DJ-N12XB-5 LD-DJ-N12BB-5

Single Color / IP65

Series	Product			PCB Width	LED QTY	Product NO.
	BB PCB to PCB	XB Cable to PCB	BXB PCB to Cable to PCB			
LD-TG Series Maximum voltage: 36V Maximum current: 5A			/	8mm 0.31"	30-120 LEDs/M 9-36LEDs/ft	LD-TG-N8BB-2 LD-TG-N8XB-2
				10mm 0.39"	30-120 LEDs/M 9-36LEDs/ft	LD-TG-N10BB-2 LD-TG-N10XB-2

RGB / IP65

Series	Product			PCB Width	LED QTY	Product NO.
	BB PCB to PCB	XB Cable to PCB	BXB PCB to Cable to PCB			
LD-TG Series Maximum voltage: 36V Maximum current: 5A			/	10mm 0.39"	30-120 LEDs/M 9-36LEDs/ft	LD-TG-N10BB-4 LD-TG-N10XB-4

Clips / IP20

LD-KZ Product	PCB Width	Product NO.
	8mm 0.31"	LD-KZ-8DJ
	8mm 0.31"	LD-KZ-8LB
	10mm 0.39"	LD-KZ-10DJ
	10mm 0.39"	LD-KZ-10LB
	10mm 0.39"	LD-KZ-12LB

Cable Fast Connector / IP20

Product	Product NO.
	LD-XC-JXD-D2
	LD-XC-JXD-H2
	LD-XC-JXD-T2

PCB corner Connector / IP20

FPC Product	PCB Width	Product NO.
	8mm 0.31"	LD-FPC-8SMD-L
	8mm 0.31"	LD-FPC-8SMD-T
	8mm 0.31"	LD-FPC-8SMD-X
	10mm 0.39"	LD-FPC-10SMD-L
	10mm 0.39"	LD-FPC-10SMD-T
	10mm 0.39"	LD-FPC-10SMD-X
	10mm 0.39"	LD-FPC-10RGB-L
	10mm 0.39"	LD-FPC-10RGB-T
	10mm 0.39"	LD-FPC-10RGB-X

ALUMINUM PROFILE LIST



AL6063 material have
good heat dissipation



Vavious sizes for optional,
To meet the needs of different
installation site



Surface oxidation treatment for
corrosion resistance



Surface color is customizable



LD-2020

High Quality Aluminum Profiles for commercial and residential LED strip lighting applications. Suitable for recessed installation in window, in-ceiling or in-wall accent decor lighting.



ALUMINUM PROFILE LIST

Product NO.	Section diagram (mm)	Strip Width	Recommended LED QTY	Accessories	Cover
LD-2020		8-15mm 0.31-0.59"	≥120 LEDs/m 36LEDs/ft		PC transparent PC opal

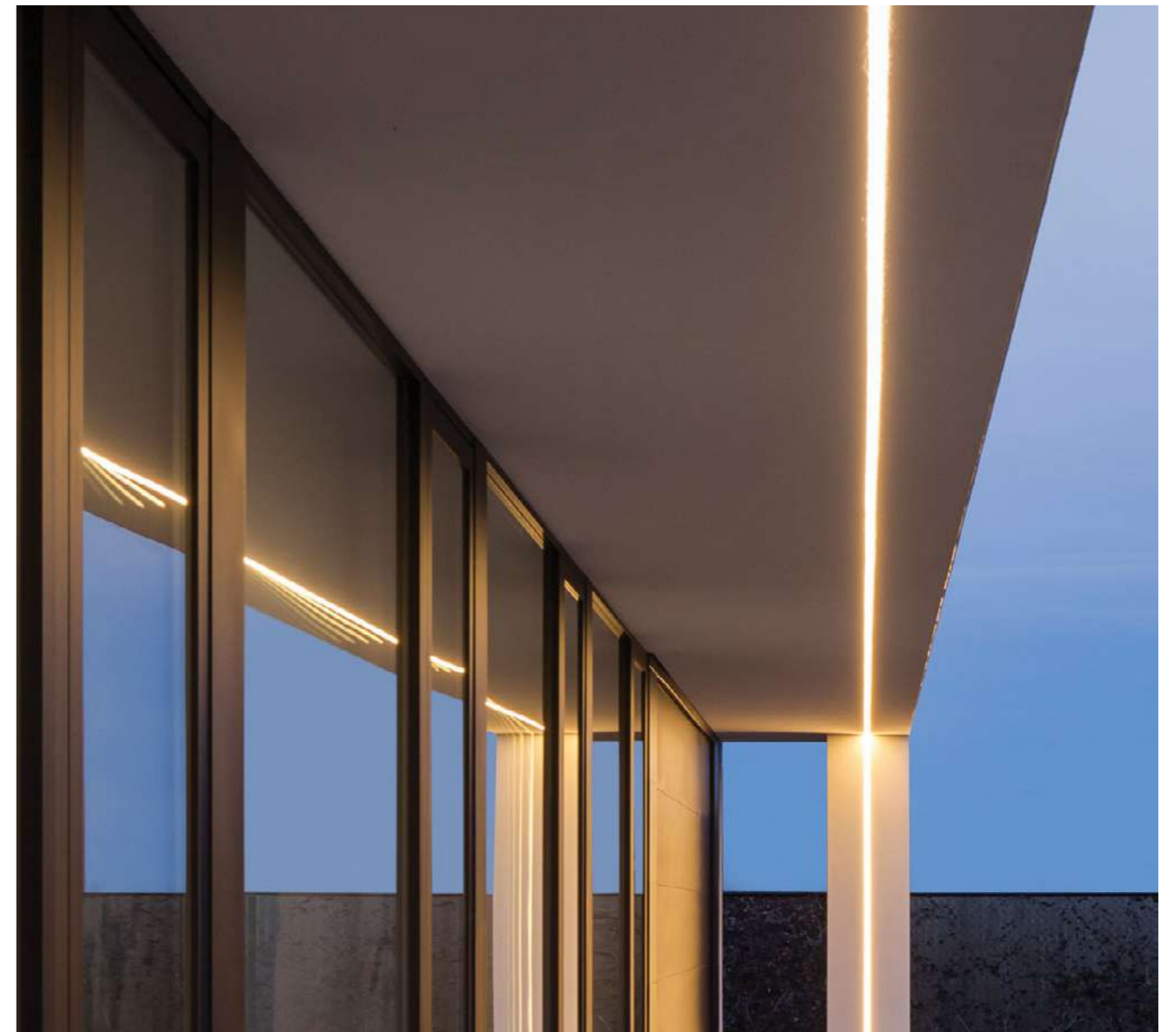

ALUMINUM PROFILE LIST

LD-1013

Slim Aluminum profile is suitable for all concealed lighting applications including under-cabinet lighting, display case lighting, restaurant & bar lighting etc.

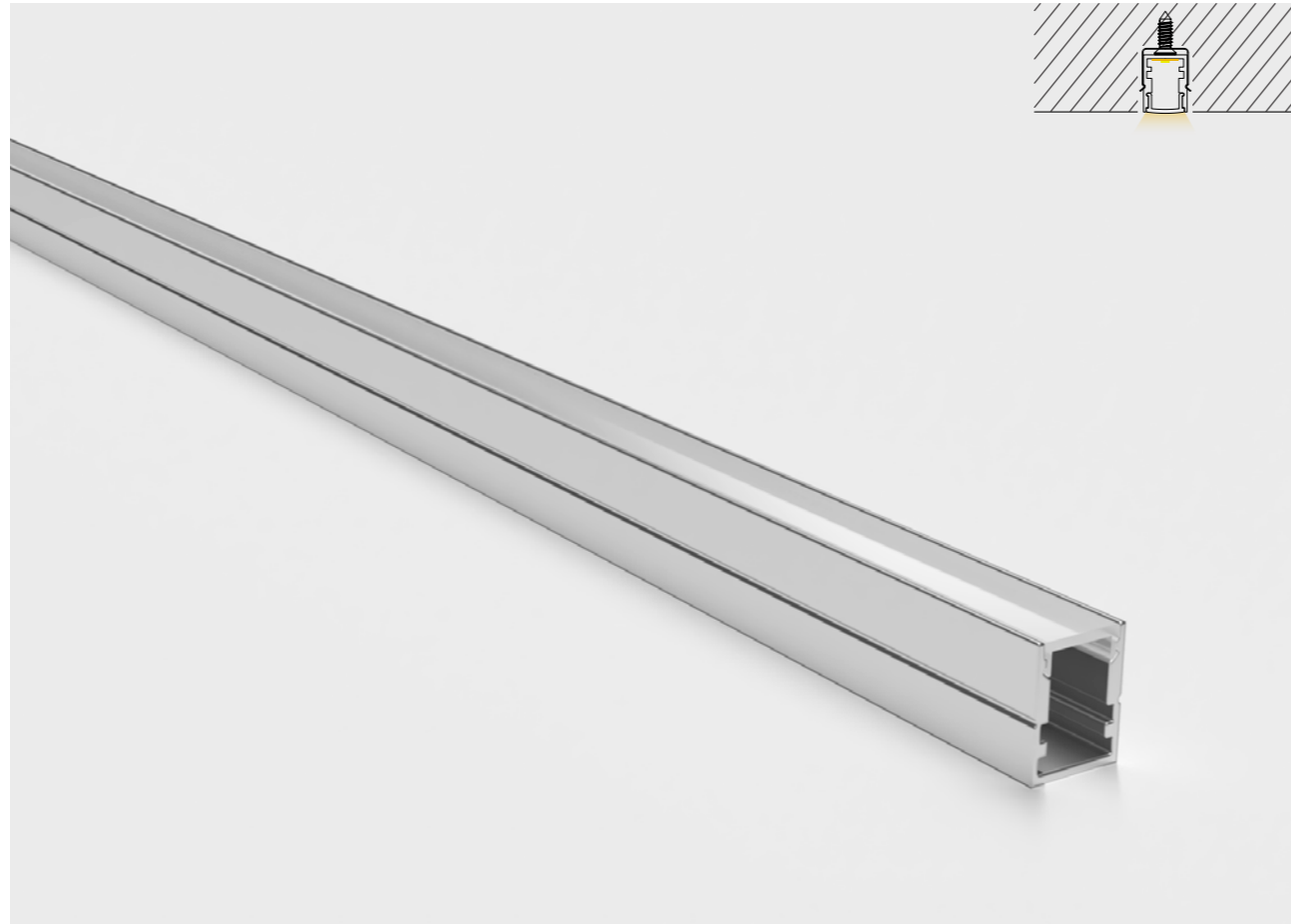

ALUMINUM PROFILE LIST

Product NO.	Section diagram (mm)	Strip Width	Recommenede LED QTY	Cover
LD-1013		6-8mm 0.31"-0.24"	\geq 120LEDs \geq 37LEDs/ft	PC transparent PC opal
Accessories				

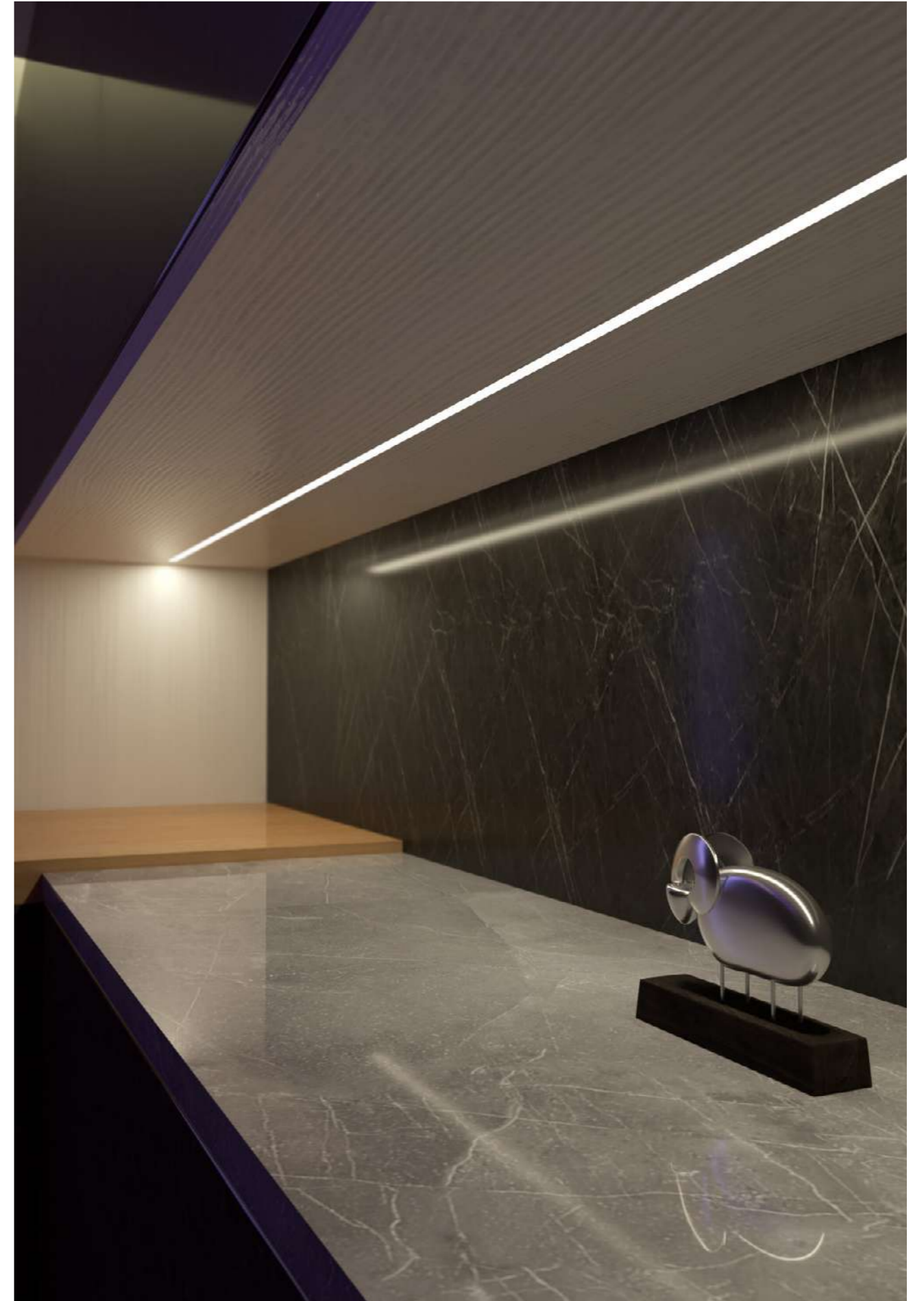

ALUMINUM PROFILE LIST

LD-1616

Slim Aluminum Profile for 90° Corner Mounting. It can be mounted in pre-made slots of Woodworking and drywall structures. It's suitable for all concealed lighting applications including joinery lighting, cove lighting, under-cabinet lighting, display case lighting, restaurant & bar lighting, residential strip-lighting etc.

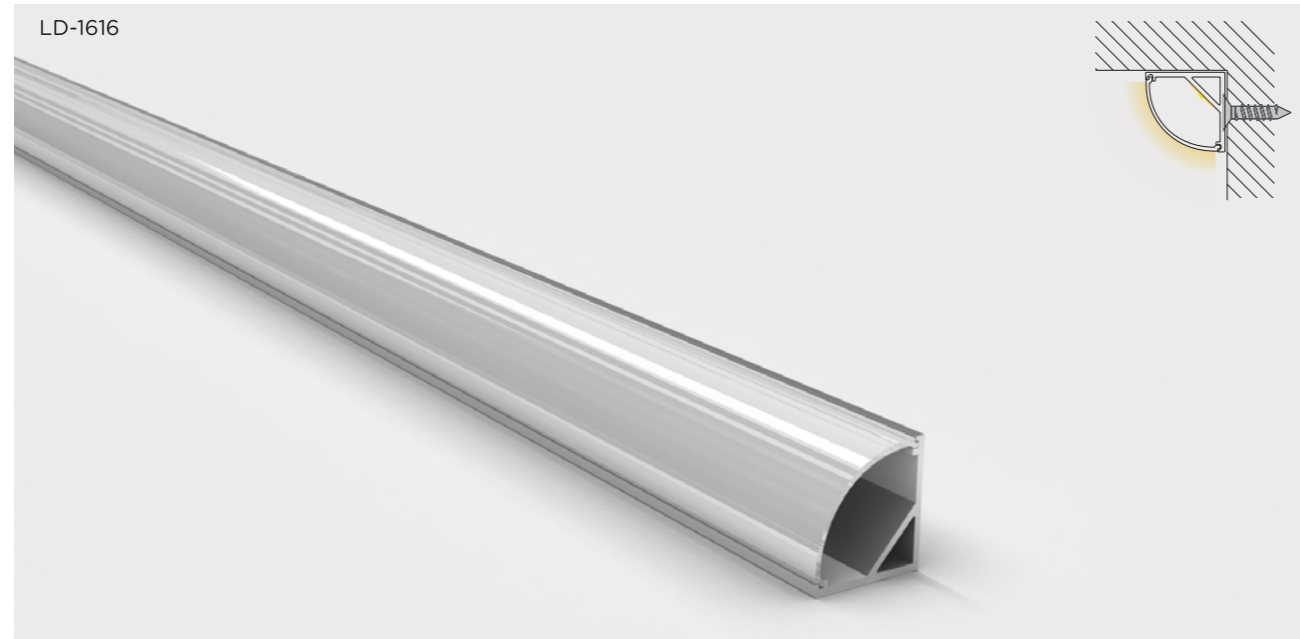

ALUMINUM PROFILE LIST

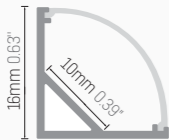
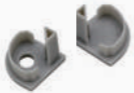
Product NO.	Section diagram (mm)	Strip Width	Recommended LED QTY	Accessories	Cover
LD-1616		8-10mm 0.31"-0.39"	≥ 120LEDs ≥ 37LEDs/ft		PC transparent PC opal

Accessories



Cover

Clips



ALUMINUM PROFILE LIST

LD2415

Aluminum profiles with wings to conceal the groove. And 14.5mm deep light emitting distance to offer soft light output with light dot free.

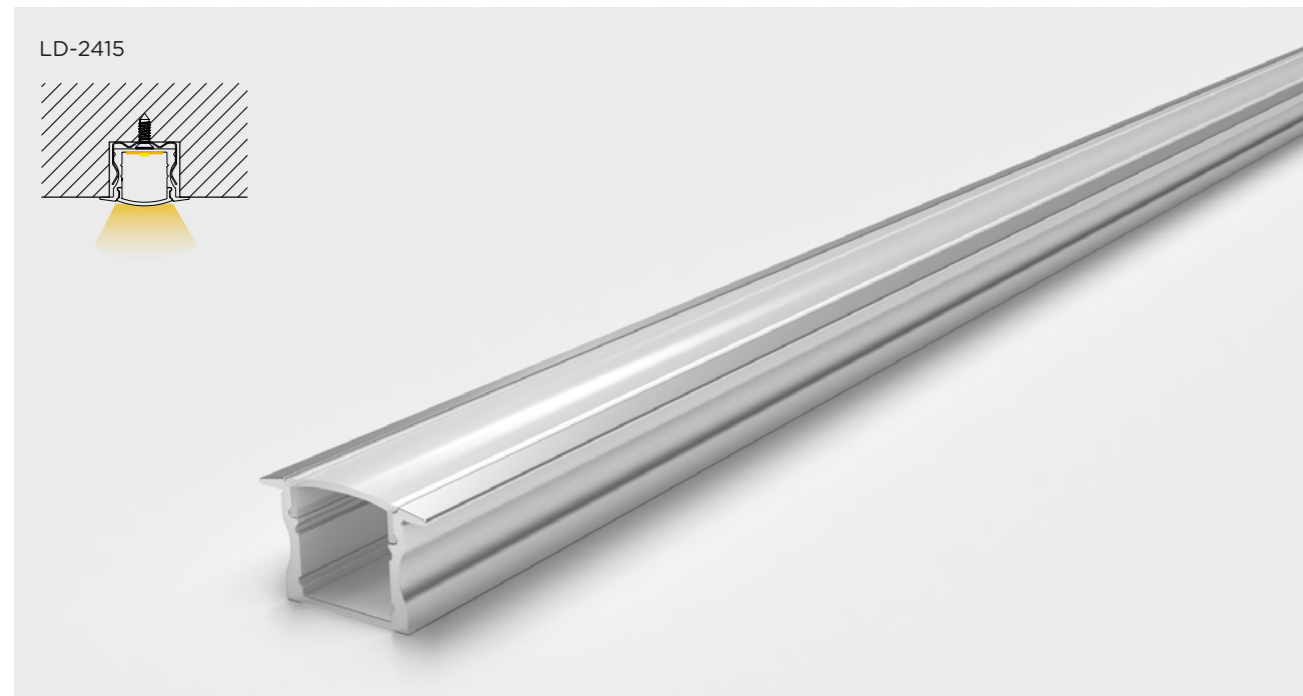

ALUMINUM PROFILE LIST

Product NO.	Section diagram (mm)	Strip Width	Recommende LED QTY	Accessories	Cover
LD-2415		8-12mm 0.31"-0.47"	≥ 96LEDs ≥ 29LEDs/ft		PC transparent PC opal

Accessories

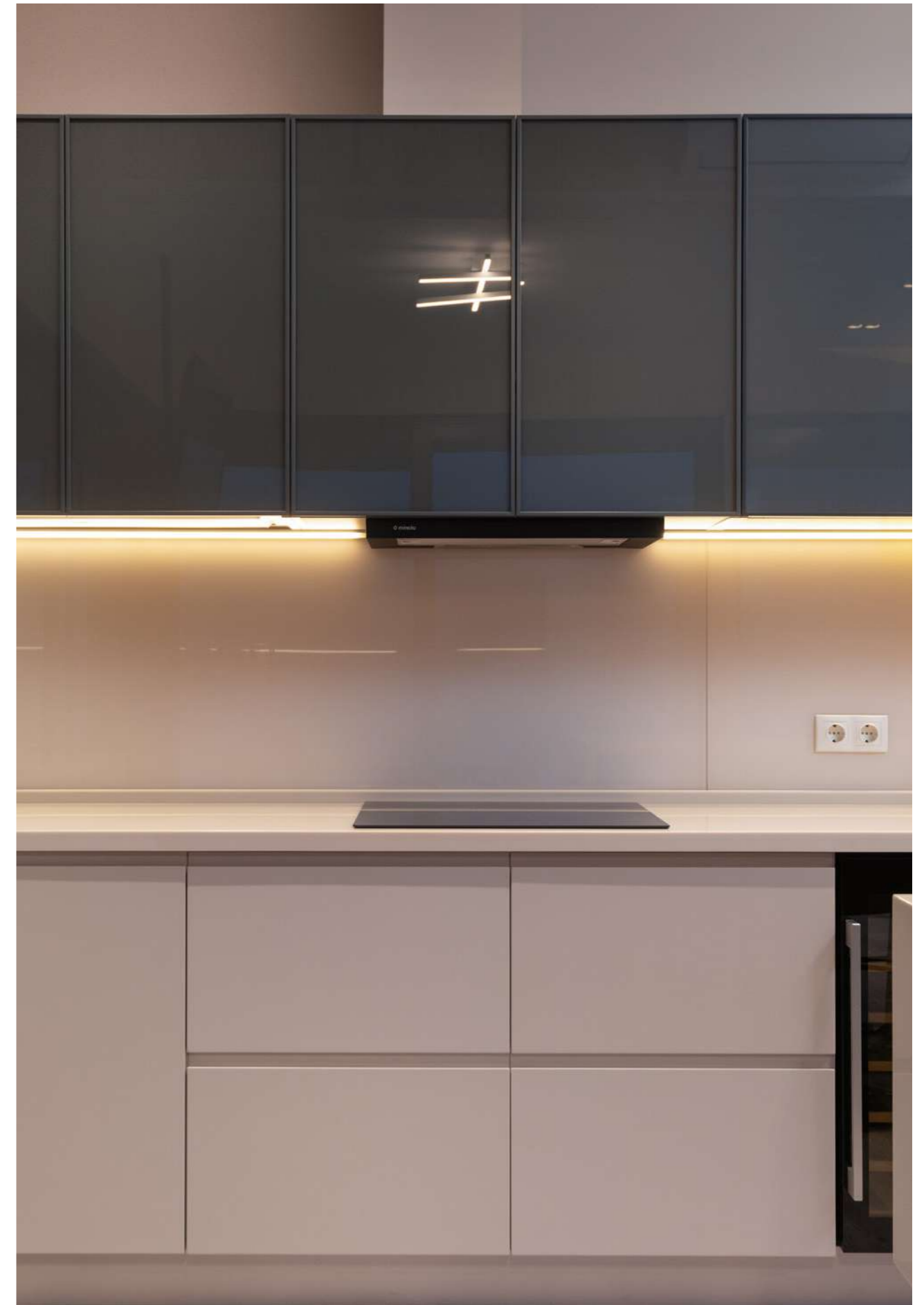
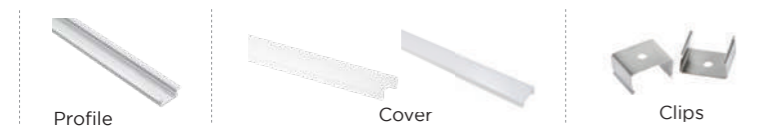



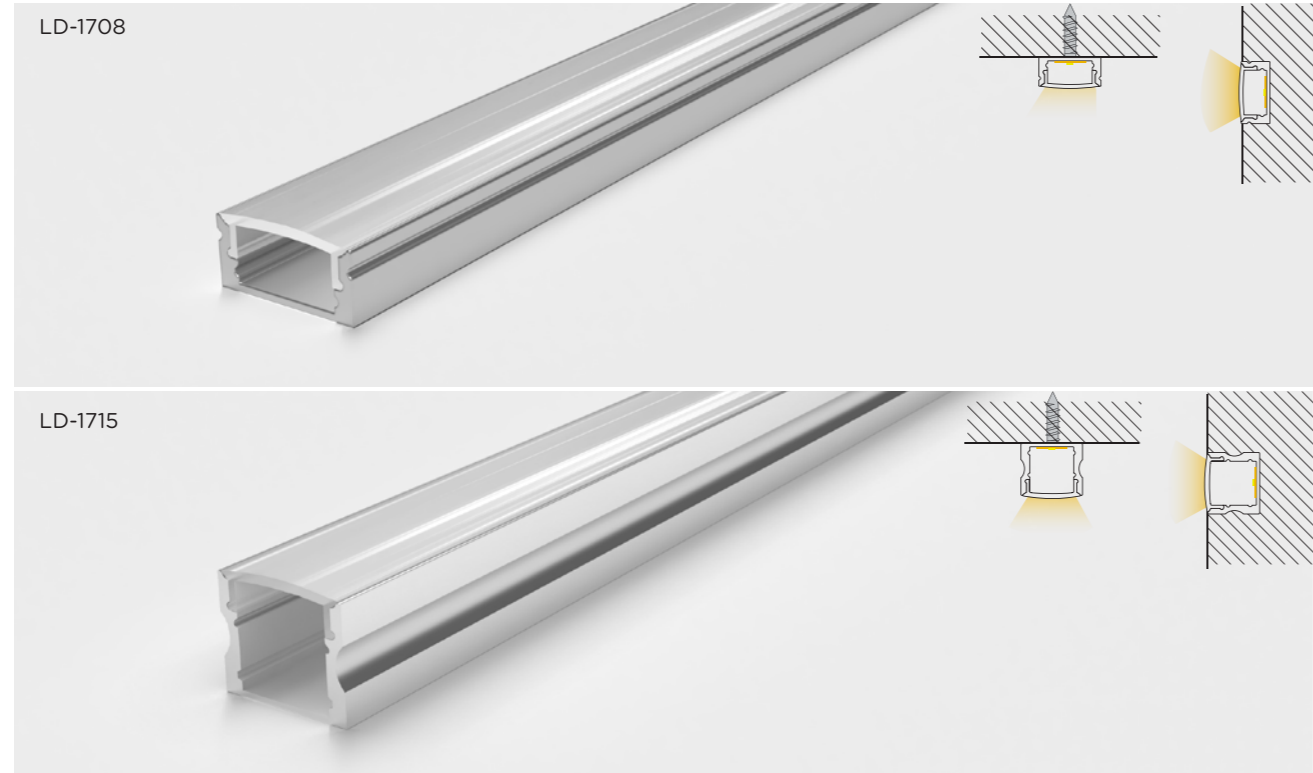

ALUMINUM PROFILE LIST

LD-1708 / LD-1715

High Quality Aluminum Profile for commercial and residential LED strip lighting applications. It's suitable for recessed installation in window, in-ceiling or in-wall accent decor lighting, under-cabinet lighting, display case lighting, restaurant & bar lighting, etc.

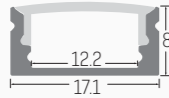

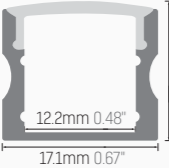
ALUMINUM PROFILE LIST

Product NO.	Section diagram (mm)	Strip Width	Recommended LED QTY	Accessories	Cover
LD-1708		8-12mm 0.31"-0.47"	≥ 240LEDs ≥ 73LEDs/ft		PC transparent PC opal
LD-1715		8-12mm 0.31"-0.47"	≥ 96LEDs ≥ 29LEDs/ft		PC transparent PC opal

Accessories



ALUMINUM PROFILE LIST

LD-3020

High Quality Aluminum Profile for commercial and residential LED strip lighting applications. It's suitable for recessed installation in window, in-ceiling or in-wall accent decor lighting, under-cabinet lighting, display case lighting, restaurant & bar lighting, etc.

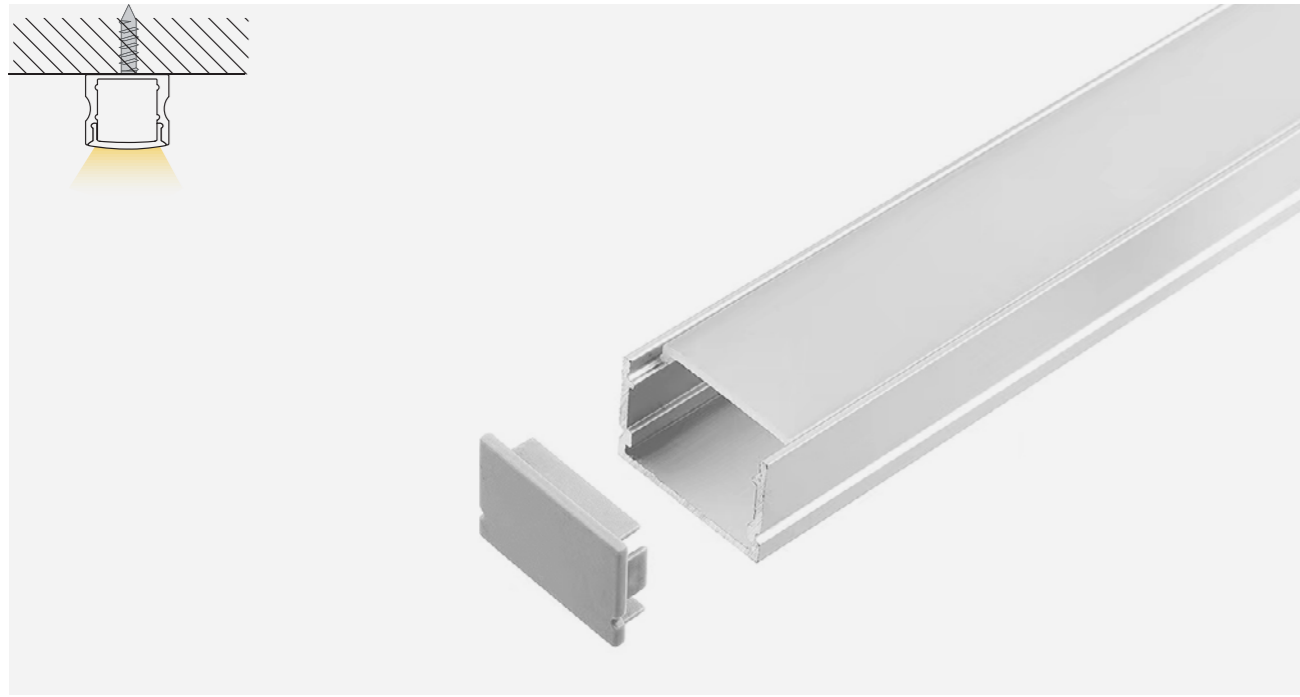

ALUMINUM PROFILE LIST

Product NO.	Section diagram (mm)	Strip Width	Recommenede LED QTY	Cover
LD-3020		8-27mm 0.31"-1.06"	$\geq 96\text{LEDs/m}$ $\geq 29\text{LEDs/ft}$	PC transparent PC opal

Accessories

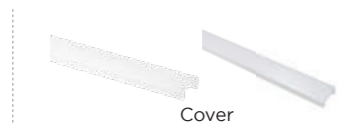

Cover



ALUMINUM PROFILE LIST

LD-1207

High Quality Aluminum Profile for commercial and residential LED strip lighting applications. It's suitable for recessed installation in window, in-ceiling or in-wall accent decor lighting, under-cabinet lighting, display case lighting, restaurant & bar lighting, etc.

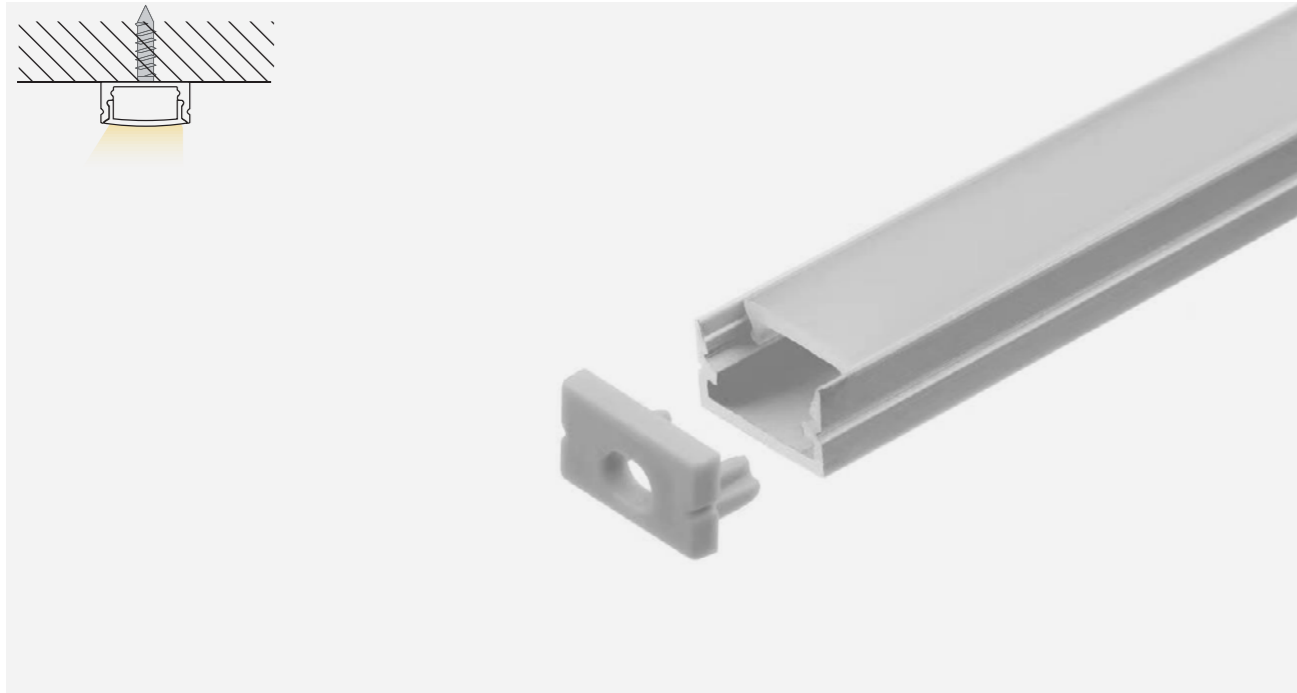

ALUMINUM PROFILE LIST

Product NO.	Section diagram (mm)	Strip Width	Recommende LED QTY	Cover
LD-1207		6-10mm 0.24"-0.39"	$\geq 120\text{LEDs/m}$ $\geq 59\text{LEDs/ft}$	PC transparent PC opal

Accessories



Cap

Profile

Cover

Clips

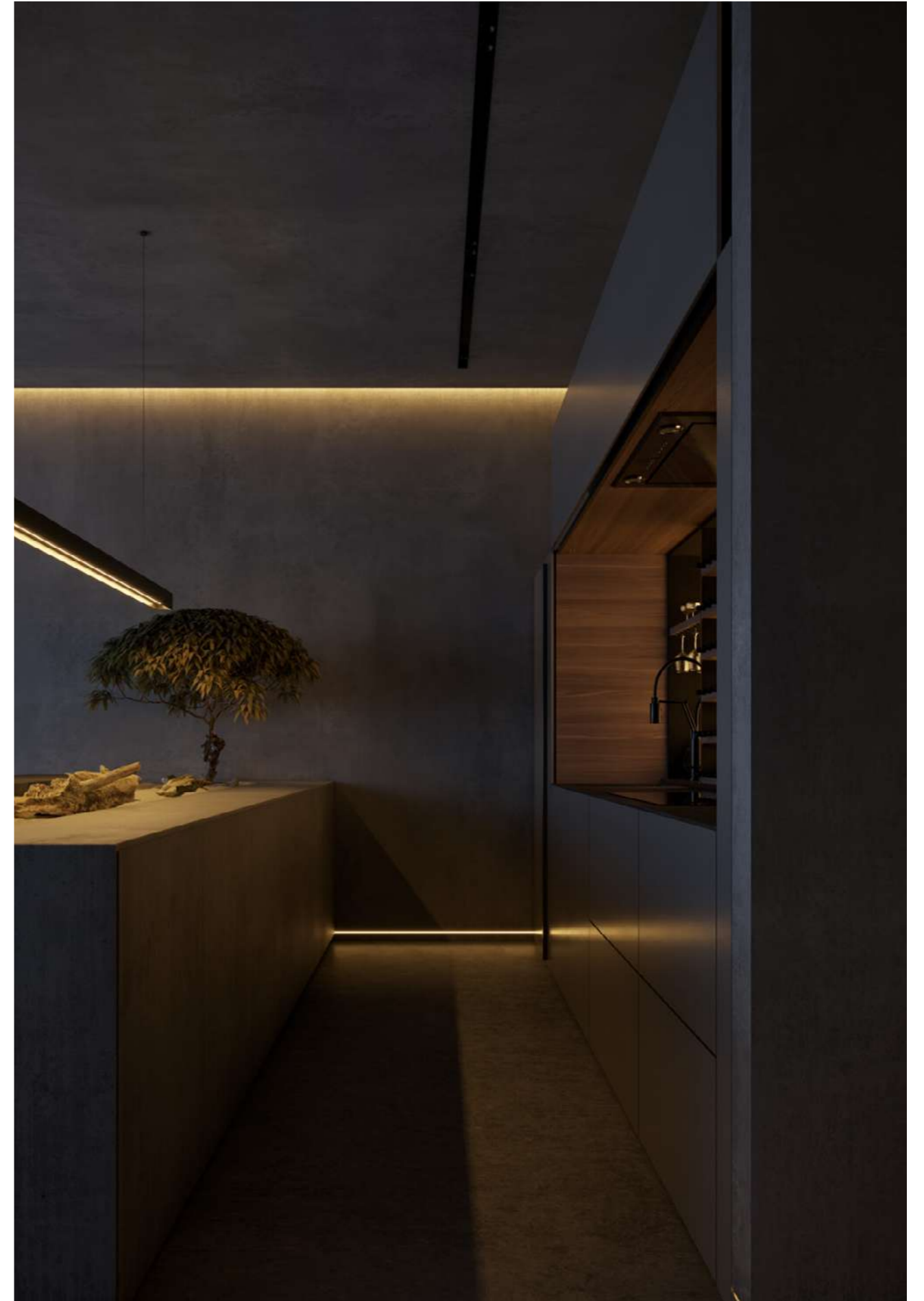

ALUMINUM PROFILE LIST

LED DRIVER

Non-Waterproof Power Supply Compact Series

Class II,SELV,independent
 Input voltage : 220-240VAC
 Protection: SCP/OLP/OVP/OTP
 PF>0.9
 High Efficiency



Please contact our sales for the latest details and certifications.

Technical Details

Input voltage: 220-240VAC / Output voltage: 24V / Warranty: 5 year

Product NO.	Power	Output current	PF	Working Temperature
DVH30-24-PO-G1 CP PC	30W ≥87%	0-1.25A	>0.9A	-20-45°C
DVH60-24-PO-G1 CP PC	60W ≥88%	0-2.5A	>0.9A	-10-45°C
DVH75-24-PO-G1 CP PC	75W ≥88%	0-3.125A	>0.9A	-20-45°C
DVH120-24-PO-G1 CP PC	120W ≥91%	0-5A	>0.9A	-20-40°C
DVH150-24-PO-G1 CP PC	150W ≥91%	0-6.25A	>0.9A	-20-40°C

Dimension

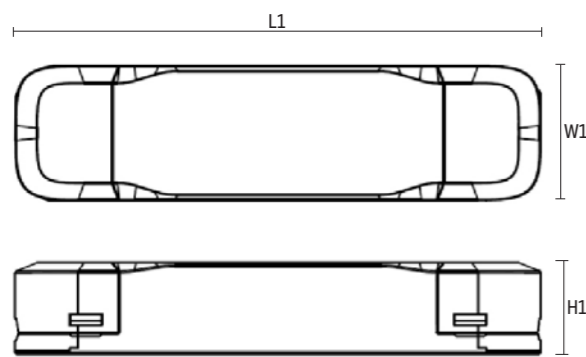

Product NO.	L1(mm)	W1(mm)	H1(mm)
DVH30-24-PO-G1 CP PC	160	42	30
DVH60-24-PO-G1 CP PC	187	45	30.5
DVH75-24-PO-G1 CP PC	187	45	30.5
DVH120-24-PO-G1 CP PC	268	45	30.5
DVH150-24-PO-G1 CP PC	268	45	30.5

Non-Waterproof Power Supply Desktop Series

Protection: Short-circuit/Over-current/Over-voltage/
 Over-temperature protection
 LED indicator for power on
 Free Air Convection
 100% full load burn-in test
 Class I,built-in
 Input Surge Protection:1kV line-line,2kV line-earth



Please contact our sales for the latest details and certifications.

Technical Details

Input voltage: 220-240VAC / Output voltage: 24V / Warranty: 3 year

Product NO.	Power	Output current	Input voltage	PF	Working Temperature
DVE35-24-PO-G1 PN FE	35W ≥87%	0-1.5A	100-240VAC	>0.45	-30-70°C
DVE50-24-PO-G1 PN FE	50W ≥87%	0-2.2A	100-240VAC	>0.45	-30-70°C
DVE100-24-PO-G1 PN FE	100W ≥89%	0-4.5A	100-240VAC	>0.45	-30-70°C
DVE150-24-PO-G1 PN FE	150W ≥89%	0-6.5A	100-120VAC 200-240VAC	>0.45	-30-70°C
DVE200-24-PO-G1 PN FE	200W ≥89%	0-8.3A	100-120VAC 200-240VAC	>0.5	-25-70°C
DVE350-24-PO-G1 PN FE	350W ≥87%	0-14.6A	100-120VAC 200-240VAC	>0.5	-25-70°C

Dimension

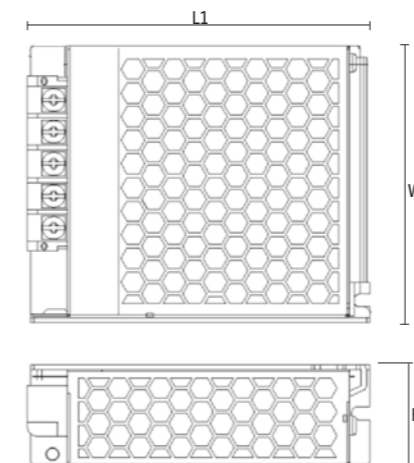

Product NO.	L1(mm)	W1(mm)	H1(mm)
DVE35-24-PO-G1 PN FE	100	82	30
DVE50-24-PO-G1 PN FE	100	82	30
DVE100-24-PO-G1 PN FE	130	97	30
DVE150-24-PO-G1 PN FE	160	97	30
DVE200-24-PO-G1 PN FE	215	115	30
DVE350-24-PO-G1 PN FE	215	115	30

Non-Waterproof Power Supply Linear Series

Class II,SELV,independent
 Input voltage : 220-240VAC
 Protection: SCP/OLP/OVP/OTP
 PF>0.95
 High Efficiency



Please contact our sales for the latest details and certifications.

Technical Details

Input voltage: 220-240VAC / Output voltage: 24V / Warranty: 5 year

Product NO.	Power	Output current	PF	Working Temperature
DVH30-24-P0-G1 LS PC	30W ≥83%	0-1.25A	>0.95A	-20-45°C
DVH60-24-P0-G1 LS PC	60W ≥87%	0-2.5A	>0.95A	-20-45°C
DVH100-24-P0-G1 LS PC	100W ≥88%	0-4.5A	>0.95A	-20-45°C
DVH160-24-P0-G1 LS PC	160W ≥92%	0-6.6A	>0.95A	-20-45°C

Dimension

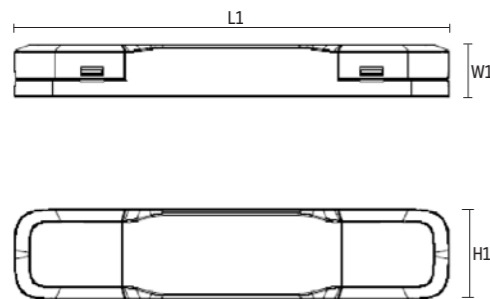

Product NO.	L1(mm)	W1(mm)	H1(mm)
DVH30-24-P0-G1 LS PC	261	17	30
DVH60-24-P0-G1 LS PC	329	17	30
DVH100-24-P0-G1 LS PC	365	18	30
DVH160-24-P0-G1 LS PC	395	21.5	30.5

Waterproof Power Supply Linear Series

High Efficiency
 Built-in active PFC function
 No load Power consumption
 All-Around Protection: OCP,SCP,OTP
 Compact Metal Case, Free Air Convection
 Waterproof(IP67) and UL Dry/Damp/Wet Location
 Input Surge Protection:4kV line-line,6kVline-earth



Please contact our sales for the latest details and certifications.

Technical Details

Input voltage: 220-240VAC / Output voltage: 24V / Warranty: 5 year

Product NO.	Power	Output current	PF	Working Temperature
DVH75-24-P7-G1 LS AL	75W ≥88%	0-3.125A	>0.95	-40-70°C
DVH100-24-P7-G1 LS AL	100W ≥89%	0-4.15A	>0.95	-40-70°C
DVH150-24-P7-G1 LS AL	150W ≥92%	0-6.25A	>0.95	-40-70°C
DVH200-24-P7-G1 LS AL	200W ≥92%	0-8.33A	>0.95	-40-70°C
DVH300-24-P7-G1 LS AL	300W ≥94%	0-12.5A	>0.95	-45-70°C

Dimension

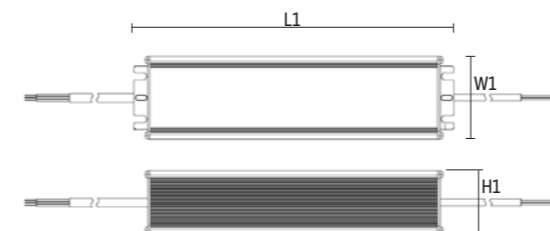

Product NO.	L1(mm)	W1(mm)	H1(mm)
DVH75-24-P7-G1 LS AL	165	60	36.5
DVH100-24-P7-G1 LS AL	167	60	34.6
DVH150-24-P7-G1 LS AL	167	60	34.6
DVH200-24-P7-G1 LS AL	216	65	39.5
DVH300-24-P7-G1 LS AL	265	68	39.5

Non-Waterproof Power Supply Linear Series

Driver / Aluminum housing
DC5-48V / AC220-240V
IP20 / Square shape / terminal blocks
High Efficiency



Please contact our sales for the latest details and certifications.

Technical Details

Input voltage: 100-120VAC 200-240VAC / Output voltage: DC5-48V / Warranty: 3 year

Product NO.	Power	Input volt	Output volt	PF	Working Temperature
DVE100-P0-G1 PN FE	100W	100-120VAC 200-240VAC	DC5-48V	>0.90	-20-45°C
DVE150-P0-G1 PN FE	150W	100-120VAC 200-240VAC	DC5-48V	>0.90	-20-45°C
DVE200-P0-G1 PN FE	200W	100-120VAC 200-240VAC	DC5-48V	>0.93	-20-45°C
DVE350-P0-G1 PN FE	350W	100-120VAC 200-240VAC	DC5-48V	>0.93	-20-45°C
DVE450-P0-G1 PN FE	450W	100-120VAC 200-240VAC	DC5-48V	>0.93	-20-45°C

Dimension

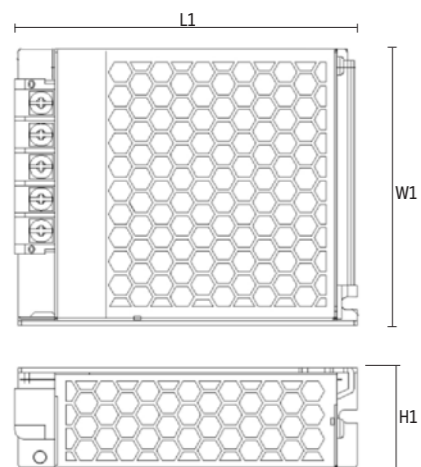

Product NO.	L1(mm)	W1(mm)	H1(mm)
DVE100 -P0-G1 PN FE	129	97	30
DVE150 -P0-G1 PN FE	159	97	30
DVE200 -P0-G1 PN FE	215	115	30
DVE350 -P0-G1 PN FE	215	115	30
DVE450 -P0-G1 PN FE	225	124	35

Non-Waterproof Power Supply Linear Series

Driver / Aluminum housing
DC5-48V / AC220-240V
IP20 / Square shape / terminal blocks
High Efficiency



Please contact our sales for the latest details and certifications.

Technical Details

Input voltage: 100-120VAC 200-240VAC / Output voltage: DC5-48V / Warranty: 5 year

Product NO.	Power	Input volt	Output volt	PF	Working Temperature
DVH100-P0-G1 PN FE	100W	100-120VAC 200-240VAC	DC5-48V	>0.90	-20-45°C
DVH150-P0-G1 PN FE	150W	100-120VAC 200-240VAC	DC5-48V	>0.90	-20-45°C
DVH200-P0-G1 PN FE	200W	100-120VAC 200-240VAC	DC5-48V	>0.93	-20-45°C
DVH300-P0-G1 PN FE	300W	100-120VAC 200-240VAC	DC548V	>0.93	-20-45°C
DVH450-P0-G1 PN FE	450W	100-120VAC 200-240VAC	DC5-48V	>0.93	-20-45°C

Dimension

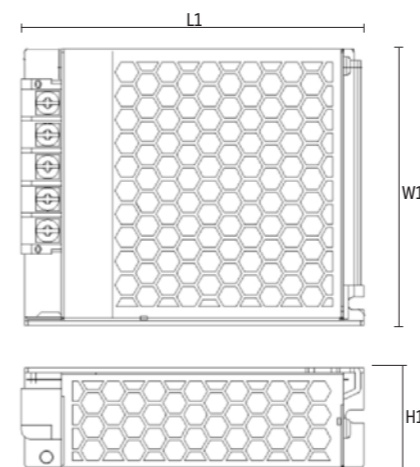

Product NO.	L1(mm)	W1(mm)	H1(mm)
DVH100-P0-G1 PN FE	159	97	358
DVH150-P0-G1 PN FE	159	97	38
DVH200-P0-G1 PN FE	199	98	38
DVH300-P0-G1 PN FE	199	105	41
DVH450-P0-G1 PN FE	218	105	41

Waterproof Power Supply Linear Series

Driver / Aluminum housing
DC5-48V / AC220-240V
IP65 / Long shape / Wire out
High Efficiency



(for DA-Type only) SELV IP65 IP67

Type HL

5 years warranty

UL62368-1

Please contact our sales for the latest details and certifications.

Technical Details

Input voltage: 100-300VAC / Output voltage: DC5-48V / Warranty: 5 year

Product NO.	Power	Input volt	Output volt	PF	Working Temperature
DVH100 -P5-G1 LS AL	100W	100-300VAC	DC5-48V	>0.90	-20-45°C
DVH150 -P5-G1 LS AL	150W	100-300VAC	DC5-48V	>0.90	-20-45°C
DVH240 -P5-G1 LS AL	240W	176-305VAC	DC5-48V	>0.93	-20-45°C

Dimension

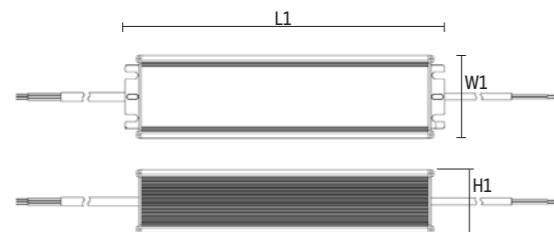

Product NO.	L1(mm)	W1(mm)	H1(mm)
DVH100 -P5-G1 LS AL	199	63	35.5
DVH150 -P5-G1 LS AL	219	63	35.5
DVH240 -P5-G1 LS AL	244	72	37.5

Waterproof Power Supply Linear Series

Driver / Aluminum housing
DC5-48V / AC220-240V
IP65 / Long shape / Wire out
High Efficiency



(except for AB, DA, DD-type) (for Blank/A-type) Type HL

5 years warranty

UL62368-1

Please contact our sales for the latest details and certifications.

Technical Details

Input voltage: 176-305VAC / Output voltage: DC5-48V / Warranty: 5 year

Product NO.	Power	Input volt	Output volt	PF	Working Temperature
DVH320 -P5-G1 LS AL	320W	176-305VAC	DC5-48V	>0.93	-20-45°C
DVH320 -P5-G1 DA AL	320W	176-305VAC	DC5-48V	>0.93	-20-45°C
DVH400 -P5-G1 LS AL	400W	176-305VAC	DC5-48V	>0.93	-20-45°C

Dimension

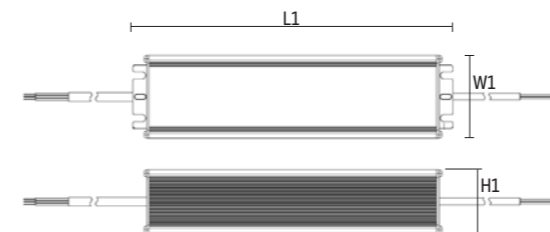









Product NO.	L1(mm)	W1(mm)	H1(mm)
DVH320 -P5-G1 LS AL	252	90	43.8
DVH320 -P5-G1 DA AL	252	90	43.8
DVH400 -P5-G1 LS AL	262	125	43.8

LED DRIVER



LED DRIVER

CONTROLLERS

DMX512







Product NO.	Product	Input Volt	Output volt	Output	Applicable	Suitable for	
CTE480-24-DMX-P0-G1-CN-12/24V-PC-D4L	 (Use with DMX512 controller)	DC12-24V	DC12-24V	DC12V:300W DC24V:480W Max. 480W	Single color Tunable RGB RGBW	Strips/fixtures	
CTE512-24-DMX-P0-G1-CN-110/240-PC-T111		AC110-240VAC	/	Single color	DMX512 Wall-mount control pad	Single color	DMX512
CTE120-24-DMX-P0-G1-CN-110/240-PC-T141		AC110-240VAC	/	RGBW	DMX512 Wall-mount control pad	RGBW	DMX512
CTE102-24-DMX-P0-G1-CN-110/240-PC-T151		AC110-240VAC	/	RGBW	DMX512 Wall-mount control pad	RGB+CCT	DMX512
 CTE720-24-DMX-P0-G1-CN-12/24V-PC-02P		DC12-36V	DC12-36V	DC12V:240W DC24V:480W DC36V:720W	CCT Tunable CCT RGB RGBW	DMX512	
 CTE720-24-DMX-P7-G1-CN-12/24V-PC-02B(WP)		DC12-36V	DC12-36V	DC12V:240W DC24V:480W DC36V:720W	CCT Tunable CCT RGB RGBW	DMX512	

SPI Controller



Product NO.	Product	Input Volt	Output volt	Output	Applicable	Suitable for
CTE2048-24-SPI-P0-G1-CN-24-PC-107		DC5-24V	DC524V	20m (2048 pixels)	APP	SPI strips WS2813 P943F SK6812 SK6815 etc.
CTE2048-24-SPI-P0-G1-CN-24-PC-105		DC5-24V	DC524V	20m (2048 pixels)	APP	SPI strips WS2813,P943F SK6812 SK6815 etc. with music function
CTE2048-24-SPI-P0-G1-CN-24-PC-SPI16		DC5-24V	DC524V	20m (2048 pixels)	Remote control	SPI strips

2.4G Remote Controller



Use with remote controller

Product NO.	Product	Input Volt	Output volt	Output	Applicable	Suitable for
CTE648-36-RF-P0-G1-CN-12/36V-PC-V3L		DC12-36V	DC12-36V	DC12V:216W DC24V:432W DC36V:648W 3CH*6A	Single color tunable RGB	Strips/fixtures
CTE240-24-RF-P0-G1-CN-12/24V-AL		DC12-24V	DC12-24V	DC12V: 3CH*72W DC24V: 3CH*144W Max.current <10A	RGB	
CTE240-24-RF-P0-G1-CN-12/24V-PC		DC12-24V	DC12-24V	DC12V: 3CH*72W DC24V: 3CH*144W Max.current <10A	RGBW	
 CTE720-36-RF-P0-G1-CN-12/36V-PC-9P		DC12-36V	4CH, 5A/CH	DC12V:240W DC24V:480W DC36V:720W	CCT Tunable CCT RGB RGBW	
 CTE720-36-RF-P7-G1-CN-12/36V-PC-9FA(WP)	 IP67	DC12-36V	4CH, 5A/CH	DC12V:240W DC24V:480W DC36V:720W	CCT Tunable CCT RGB RGBW	

Dali Controller







Product NO.	Product	Input Volt	Output volt	Output	Applicable	Suitable for
 CTE240-24-D-P0-G1-CN-12/24V-PC-DA03S		DC12-36V wide input voltage	DC12-36V wide output voltage	DC12V:96W DC24V:192W 1*8A	Single color DT8,TC PUSH	Strips/fixtures

0-10V Controller

Product NO.	Product	Input Volt	Output volt	Output	Applicable	Suitable for
 CTE432-36-D-P0-G1-CN-12/36V-PC-2001		DC12-36V wide input voltage	DC0-10V	12V<144W 24V<288W 36V<432W	Single color	Strips/fixtures







Amplifier

Use with DMX512 Decoder or Synchronous changing RGB controllers

Product NO.	Product	Input Volt	Output volt	Output	Applicable	Suitable for
 CTE576-36-D-P0-G1-CN-12/36V-PC-EV2		DC12-36V	DC12-36V	DC12V:192W DC24V:384W DC36V:576W 2CH*8A	Tunable	Strips/fixtures
 CTE648-36-D-P0-G1-CN-12/36V-PC-EV3H		DC12-36V	DC12-36V	DC12V:216W DC24V:432W DC36V:648W 3CH*6A	Single color tunable RGB	
 CTE720-36-D-P0-G1-CN-12/36V-PC-EV4		DC12-36V	DC12-36V	DC12V:240W DC24V:480W DC36V:720W 4CH*5A	Single color tunable RGB RGBW	

Remote Control







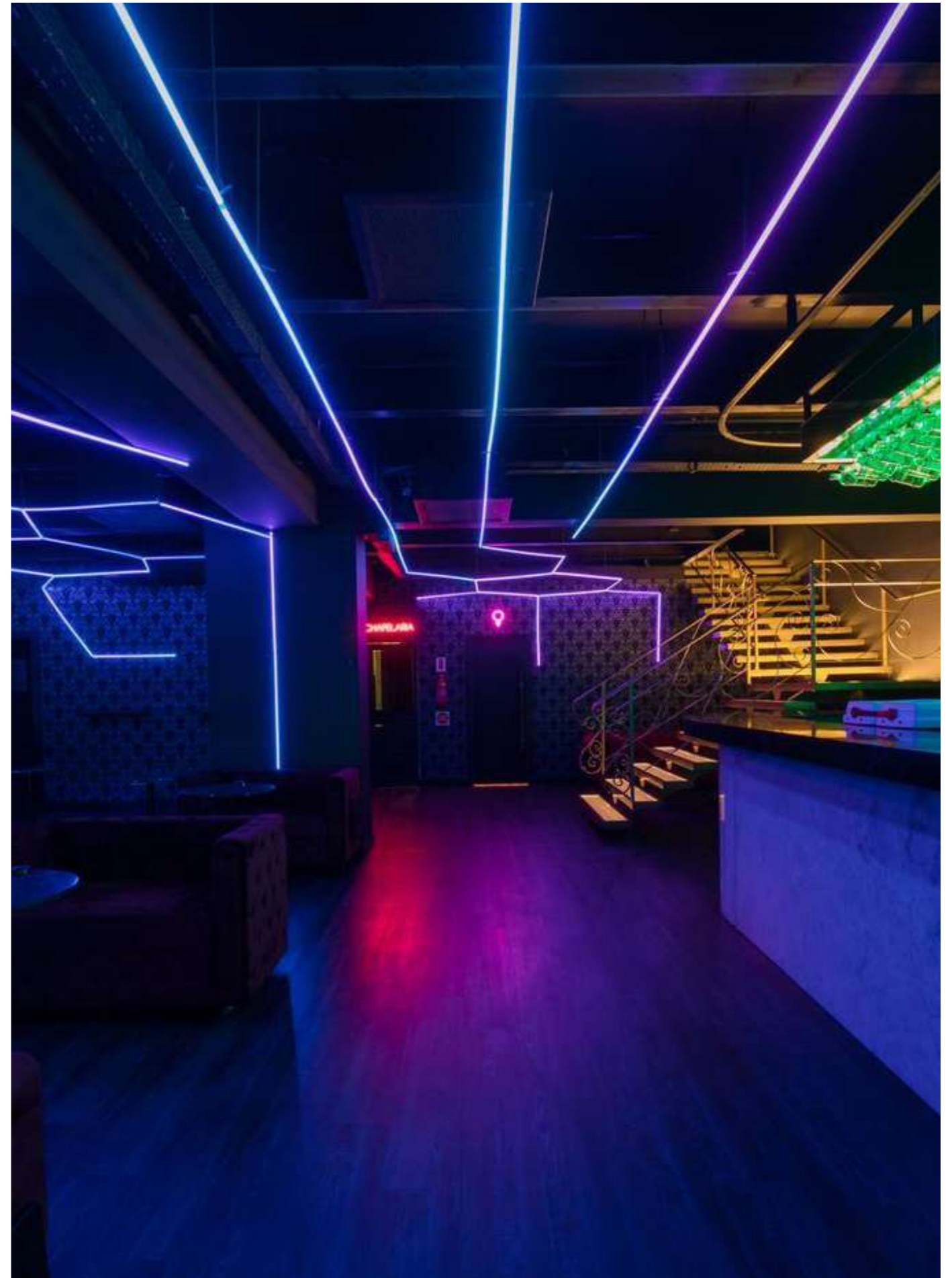





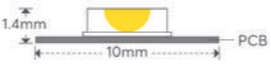

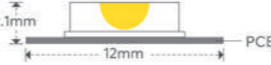
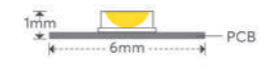

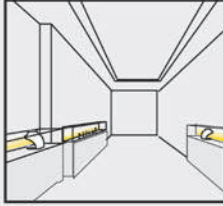





Use with the signal receiver



Product NO.	Product	Output	Applicable
 CTE4-3-D-P0-G1-CN-3V-PC-R7		2*7# battery	Tunable
 CTE1-3-D-P0-G1-CN-3V-PC-RT4		2*7# battery	RGB/RGBW 1 zone
 CTE1-3-D-P0-G1-CN-6V-PC-RF1		2*7# battery	CCT
 CTE1-3-D-P0-G1-CN-4.5V-PC-RF3		2*7# battery	RGB

Product NO.	Product	Output	Applicable
 CTE4-3-D-P0-G1-CN-3V-PC-RT9		2*7# battery	RGB/RGBW 4 zone
 CTE1-3-D-P0-G1-CN-3V-PC-RT5		2*7# battery	RGB/ RGB+CCT 1 zone
 CTE1-3-D-P0-G1-CN-3.7V-PC-RF2		2*7# battery	RGBW 4 zone

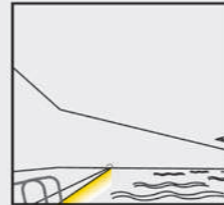
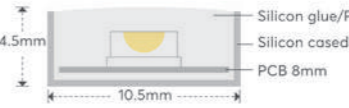
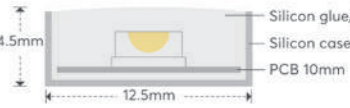
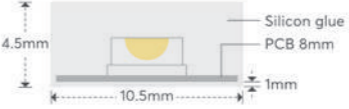
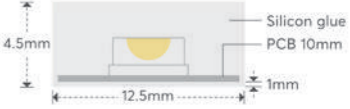
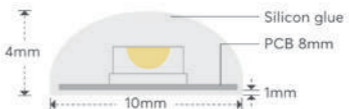
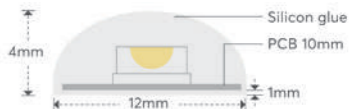
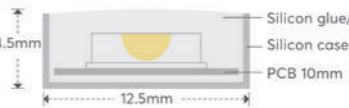
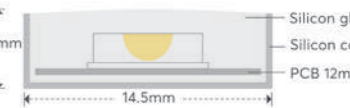
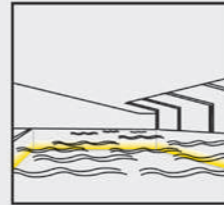
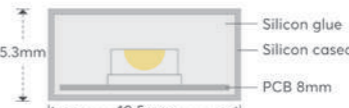

IP RATING

IP20 Ribbon Series 	2835 SMD  
	5050 SMD  
	2110 SMD  
IP62 	2835 SMD Dropper Series  
	5050 SMD Dropper Series  
	2835 SMD Hollow Extrusion  
IP65 	2835 SMD Tube Series  
	5050 SMD Tube series  
	2835 SMD Hollow Extrusion  
5050 SMD Hollow Extrusion  	

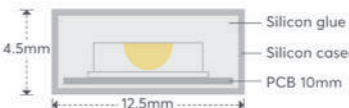
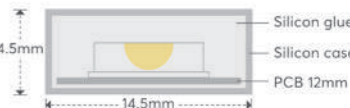
IP67 	2835 SMD Crystal series  
	2835 SMD Solid Extrusion (Square)  
	2835 SMD Solid Extrusion (Curve)  
5050 SMD Crystal series  	
IP68 	2835 SMD Jade series  
	5050 SMD Jade series  

Tolerance ±0.3mm

NAMING GUIDANCE

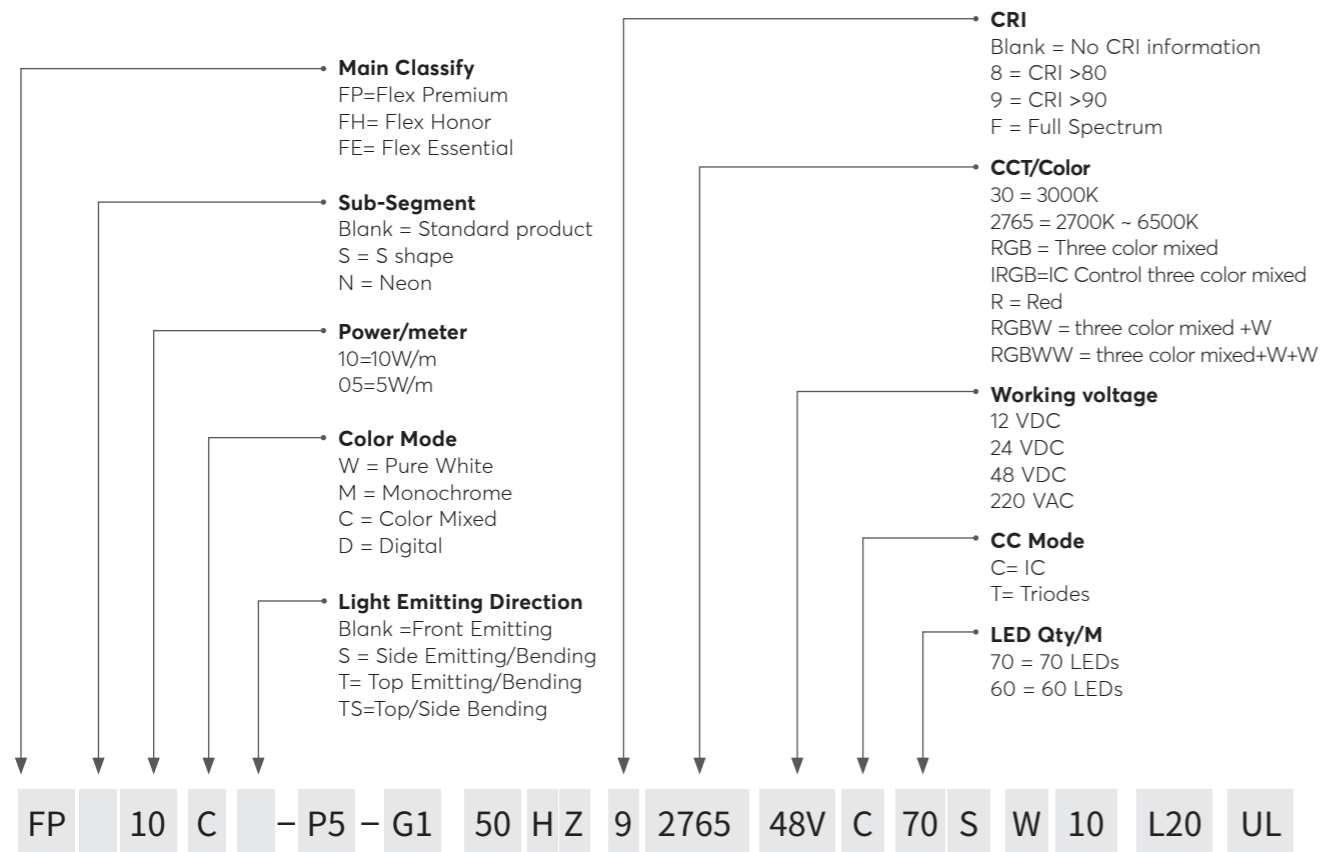

IP Rate
 P0 = IP20
 P2 = IP62
 P5 = IP65
 P7 = IP67
 P8 = IP68

Generation

LED Type
 28 = 2835
 50 = 5050
 57 = 5730
 22 = 2216
 14 = 3014
 35 = 3528
 27 = 3527
 31 = 315

2835LED Spec
 H = 60mA
 L = 20mA
 H2 = Bi-chip
 Blank= No Information

LED Series
 Z = Flex honor
 X = Flex essential
 V = Violet Full Spectrum
 S = Full Spectrum

LED Row
 S = Single Row
 D = Double Row
 T = Three Row
 F = Four Row

PCB Color
 W=White Color
 B=Black
 Y=Yellow

PCB Width
 08=8mm
 10=10mm
 12 = 12mm

Standard Length per Reel
 L05 = 5 meters
 L10 = 10 meters
 L1D1 = 1.1 meters

Certification
 Blank=CE
 UL
 VDE

Special LED type naming

Integrated color tunable series:50Z82765
 Integrated RGBW series:50ZRGB827
 Integrated RGBWW series:50ZRGB82765

SHENZHEN LEDMY CO.,LTD

SHENZHEN Marketing Center

Room1503-1505, Block 2, Excellence City, Zhongkang Road, Futian District,
Shenzhen City, Guangdong Province, PRC 518049

DONGGUAN Manufacturing Center

LEDMY Industrial Park, Tongren Road, Longbeiling Industrial Zone, Tangxia
Town, Dongguan City, Guangdong Province, PRC 523715

JIANGMEN Manufacturing Center

NO. 3 Huahui Road, Waihai Street, Jianghai District, Jiangmen City, Guangdong
Province, China, PRC 529000

Tel: +86(755)27658410 Fax: +86(755)27658502 E-mail: sales@ledmy.com



www.ledmy.com